

**Southwest Airlines
Los Angeles International Airport (LAX)
Terminal 1 Modernization Project**

Initial Study – Proposed Negative Declaration

Lead Agency:

City of Los Angeles
Los Angeles World Airports
One World Way, Room 218
Los Angeles, CA 90045

Prepared by:



111 Academy Way, Suite 150
Irvine, California 92617

March 13, 2013

CITY OF LOS ANGELES

OFFICE OF THE CITY CLERK
ROOM 615, CITY HALL
LOS ANGELES, CALIFORNIA 90012

CALIFORNIA ENVIRONMENTAL QUALITY ACT

INITIAL STUDY AND CHECKLIST

(Article IV City CEQA Guidelines)

LEAD CITY AGENCY Los Angeles World Airports (LAWA)	COUNCIL DISTRICT Council District 11	DATE March 13, 2014
RESPONSIBLE AGENCIES		
PROJECT TITLE/NO. LAX Terminal 1 Modernization Project	CASE NO.	
PREVIOUS ACTIONS CASE NO.	<input type="checkbox"/> DOES have significant changes from previous actions. <input type="checkbox"/> DOES NOT have significant changes from previous actions.	
PROJECT DESCRIPTION: The proposed project would modernize Terminal 1 to improve efficiency and increase the passenger level of service while meeting evolving federal security requirements. The proposed project includes reconfiguring the existing terminal uses to improve passenger services and amenities, better accommodate security requirements, and improve curbside circulation. Additional components include an addition to the building square footage; modifications of the gates, including an overall reduction of one gate (from 15 gates to 14); upgrading existing mechanical systems and infrastructure; interior improvements; and potential upgrades to the exterior façade. Please see Attachment A for a more detailed description of the proposed project.		
ENVIRONMENTAL SETTING: The environmental setting is characterized by a highly-built environment with vehicle, aircraft, and passenger movement activity within and adjacent to the site throughout the day and night. The adjacent area is a highly-developed, urbanized area consisting of airport, commercial, transportation (i.e., interstate highways) and residential uses.		
PROJECT LOCATION The project site is within the eastern portion of LAX, which is situated within the City of Los Angeles, an incorporated city within Los Angeles County. The project site is the existing Terminal 1 building located within the airport's Central Terminal Area. Related construction staging activities would occur on other airport property.		
PLANNING DISTRICT LAX Specific Plan	STATUS: <input type="checkbox"/> PRELIMINARY <input type="checkbox"/> PROPOSED <input checked="" type="checkbox"/> ADOPTED (December 14, 2004, as amended May 21, 2013)	
EXISTING ZONING LAX - A Zone: Airport Airside Sub-Area	<input checked="" type="checkbox"/> DOES CONFORM TO PLAN	
PLANNED LAND USE & ZONE Airport-related airside uses; no change in zone is proposed	<input type="checkbox"/> DOES NOT CONFORM TO PLAN	
SURROUNDING LAND USES North – Airport Airside (North Runways); East – Airport Roadways and Parking; South – Airport Landside (Central Terminal Area); West – Airport Landside (Terminal 2)	<input type="checkbox"/> NO DISTRICT PLAN	

 **DETERMINATION (To be completed by Lead Agency)**

On the basis of this initial evaluation:

I find that the proposed project COULD NOT have a significant effect on the environment, and a NEGATIVE DECLARATION will be prepared.

I find that although the proposed project could have a significant effect on the environment, there will not be a significant effect in this case because revisions on the project have been made by or agreed to by the project proponent. A MITIGATED NEGATIVE DECLARATION will be prepared.

I find the proposed project MAY have a significant effect on the environment, and an ENVIRONMENTAL IMPACT REPORT is required.

I find the proposed project MAY have a "potentially significant impact" or "potentially significant unless mitigated" impact on the environment, but at least one effect 1) has been adequately analyzed in an earlier document pursuant to applicable legal standards, and 2) has been addressed by mitigation measures based on earlier analysis as described on attached sheets. An ENVIRONMENTAL IMPACT REPORT is required, but it must analyze only the effects that remain to be addressed.

I find that although the proposed project could have a significant effect on the environment, because all potentially significant effects (a) have been analyzed adequately in an earlier EIR or NEGATIVE DECLARATION pursuant to applicable standards, and (b) have been avoided or mitigated pursuant to that earlier EIR or NEGATIVE DECLARATION, including revisions or mitigation measures that are imposed upon the proposed project, nothing further is required.



SIGNATURE

Chief of Airport Planning

TITLE

EVALUATION OF ENVIRONMENTAL IMPACTS:

- 1) A brief explanation is required for all answers except "No Impact" answers that are adequately supported by the information sources a lead agency cites in the parentheses following each question. A "No Impact" answer is adequately supported if the referenced information sources show that the impact simply does not apply to projects like the one involved (e.g., the project falls outside a fault rupture zone). A "No Impact" answer should be explained where it is based on project-specific factors as well as general standards (e.g., the project will not expose sensitive receptors to pollutants based on a project-specific screening analysis).
- 2) All answers must take account of the whole action involved, including off-site as well as on-site, cumulative as well as project-level, indirect as well as direct, and construction as well as operational impacts.
- 3) Once the lead agency has determined that a particular physical impact may occur, then the checklist answers must indicate whether the impact is potentially significant, less than significant with mitigation, or less than significant. "Potentially Significant Impact" is appropriate if there is substantial evidence that an effect may be significant. If there are one or more "Potentially Significant Impact" entries when the determination is made, an EIR is required.
- 4) "Negative Declaration: Less Than Significant With Mitigation Incorporated" applies where the incorporation of a mitigation measure has reduced an effect from "Potentially Significant Impact" to "Less Than Significant Impact." The lead agency must describe the mitigation measures, and briefly explain how they reduce the effect to a less than significant level (mitigation measures from Section XVII, "Earlier Analysis," cross referenced).

- 5) Earlier analysis must be used where, pursuant to the tiering, program EIR, or other CEQA process, an effect has been adequately analyzed in an earlier EIR, or negative declaration. Section 15063(c)(3)(D). In this case, a brief discussion should identify the following:
 - 1) Earlier Analysis Used. Identify and state where they are available for review.
 - 2) Impacts Adequately Addressed. Identify which effects from the above checklist were within the scope of and adequately analyzed in an earlier document pursuant to applicable legal standards, and state whether such effects were addressed by mitigation measures based on the earlier analysis.
 - 3) Mitigation Measures. For effects that are "Less Than Significant With Mitigation Measures Incorporated," describe the mitigation measures which were incorporated or refined from the earlier document and the extent to which they address site-specific conditions for the project.
- 6) Lead agencies are encouraged to incorporate into the checklist references to information sources for potential impacts (e.g., general plans, zoning ordinances). Reference to a previously prepared or outside document should, where appropriate, include a reference to the page or pages where the statement is substantiated.
- 7) Supporting Information Sources: A sources list should be attached, and other sources used or individuals contacted should be cited in the discussion.
- 8) This is only a suggested form, and lead agencies are free to use different formats; however, lead agencies should normally address the questions from this checklist that are relevant to a project's environmental effects in whichever format is selected.
- 9) The explanation of each issue should identify:
 - 1) The significance criteria or threshold, if any, used to evaluate each question; and
 - 2) The mitigation measure identified, if any, to reduce the impact to less than significance.

ENVIRONMENTAL FACTORS POTENTIALLY AFFECTED:

The environmental factors checked below will be potentially affected by this project, involving at least one impact that is a "Potentially Significant Impact" as indicated by the checklist on the following pages.

- | | | |
|--|--|---|
| <input type="checkbox"/> Aesthetics | <input type="checkbox"/> Hazards and Hazardous Materials | <input type="checkbox"/> Public Services |
| <input type="checkbox"/> Agricultural and Forest Resources | <input type="checkbox"/> Hydrology and Water Quality | <input type="checkbox"/> Recreation |
| <input type="checkbox"/> Air Quality | <input type="checkbox"/> Land Use and Planning | <input type="checkbox"/> Transportation/Circulation |
| <input type="checkbox"/> Biological Resources | <input type="checkbox"/> Mineral Resources | <input type="checkbox"/> Utilities |
| <input type="checkbox"/> Cultural Resources | <input type="checkbox"/> Noise | <input type="checkbox"/> Mandatory Findings of Significance |
| <input type="checkbox"/> Geology and Soils | <input type="checkbox"/> Population and Housing | |
| <input type="checkbox"/> Greenhouse Gas Emissions | | |

INITIAL STUDY CHECKLIST (To be completed by the Lead City Agency)

BACKGROUND

PROPONENT NAME

Los Angeles World Airports - Christopher Koontz

PHONE NUMBER*

(800) 919-3766

PROPONENT ADDRESS

One World Way, Room 218, Los Angeles, CA 90045

AGENCY REQUIRING CHECKLIST

Los Angeles World Airports

DATE SUBMITTED

March 13, 2014

PROPOSAL NAME (If Applicable)*

LAX Terminal 1 Modernization Project



ENVIRONMENTAL IMPACTS

(Explanations of all potentially and less than significant impacts are required to be attached on separate sheets)

	Potentially Significant Impact	Potentially Significant Unless Mitigation Incorporated	Less Than Significant Impact	No Impact
I. AESTHETICS. Would the project:				
a. Have a substantial adverse effect on a scenic vista?	<input type="checkbox"/>	<input type="checkbox"/>	<input checked="" type="checkbox"/>	<input type="checkbox"/>
b. Substantially damage scenic resources, including, but not limited to, trees, rock outcroppings, and historic buildings, or other locally recognized desirable aesthetic natural feature within a state or city-designated scenic highway?	<input type="checkbox"/>	<input type="checkbox"/>	<input checked="" type="checkbox"/>	<input type="checkbox"/>
c. Substantially degrade the existing visual character or quality of the site and its surroundings?	<input type="checkbox"/>	<input type="checkbox"/>	<input checked="" type="checkbox"/>	<input type="checkbox"/>
d. Create a new source of substantial light or glare which would adversely affect day or nighttime views in the area?	<input type="checkbox"/>	<input type="checkbox"/>	<input checked="" type="checkbox"/>	<input type="checkbox"/>
II. AGRICULTURAL AND FORESTRY RESOURCES. In determining whether impacts to agricultural resources are significant environmental effects, lead agencies may refer to the California Agricultural Land Evaluation and Site Assessment Model (1997) prepared by the California Department of Conservation as an optional model to use in assessing impacts on agriculture and farmland. In determining whether impacts to forest resources, including timberland, are significant environmental effects, lead agencies may refer to information compiled by the California Department of Forestry and Fire Protection regarding the state's inventory of forest land, including the Forest and Range Assessment Project and the Forest Legacy Assessment project; and forest carbon measurement methodology provided in Forest Protocols adopted by the California Air Resources Board. Would the project:				
a. Convert Prime Farmland, Unique Farmland, or Farmland of Statewide Importance, as shown on the maps prepared pursuant to the Farmland Mapping and Monitoring Program of the California Resources Agency, to non-agricultural use?	<input type="checkbox"/>	<input type="checkbox"/>	<input type="checkbox"/>	<input checked="" type="checkbox"/>
b. Conflict with the existing zoning for agricultural use, or a Williamson Act Contract?	<input type="checkbox"/>	<input type="checkbox"/>	<input type="checkbox"/>	<input checked="" type="checkbox"/>
c. Conflict with existing zoning for, or cause rezoning of, forest land (as defined in Public Resources Code Section 12220(g)), timberland (as defined by Public Resources Code Section 4526), or timberland zoned Timberland Production (as defined by Government Code Section 51104(g))?	<input type="checkbox"/>	<input type="checkbox"/>	<input type="checkbox"/>	<input checked="" type="checkbox"/>
d. Result in the loss of forest land or conversion of forest land to non-forest use?	<input type="checkbox"/>	<input type="checkbox"/>	<input type="checkbox"/>	<input checked="" type="checkbox"/>
e. Involve other changes in the existing environment which, due to their location or nature, could result in conversion of Farmland, to non-agricultural use or conversion of forest land to non-forest use?	<input type="checkbox"/>	<input type="checkbox"/>	<input type="checkbox"/>	<input checked="" type="checkbox"/>

Potentially Significant Impact	Potentially Significant Unless Mitigation Incorporated	Less Than Significant Impact	No Impact
-----------------------------------	---	---------------------------------	-----------

III. AIR QUALITY. The significance criteria established by the South Coast Air Quality Management District (SCAQMD) may be relied upon to make the following determinations.

Would the project:

- | | | | | |
|---|--------------------------|--------------------------|-------------------------------------|--------------------------|
| a. Conflict with or obstruct implementation of the applicable South Coast Air Quality Management District plans? | <input type="checkbox"/> | <input type="checkbox"/> | <input checked="" type="checkbox"/> | <input type="checkbox"/> |
| b. Violate any air quality standard or contribute substantially to an existing or projected air quality violation? | <input type="checkbox"/> | <input type="checkbox"/> | <input checked="" type="checkbox"/> | <input type="checkbox"/> |
| c. Result in a cumulatively considerable net increase of any criteria pollutant for which the air basin is non-attainment (O ₃ , NO ₂ , PM10, PM2.5, and lead) under an applicable federal or state ambient air quality standard (including releasing emissions which exceed quantitative thresholds for ozone precursors)? | <input type="checkbox"/> | <input type="checkbox"/> | <input checked="" type="checkbox"/> | <input type="checkbox"/> |
| d. Expose sensitive receptors to substantial pollutant concentrations? | <input type="checkbox"/> | <input type="checkbox"/> | <input checked="" type="checkbox"/> | <input type="checkbox"/> |
| e. Create objectionable odors affecting a substantial number of people? | <input type="checkbox"/> | <input type="checkbox"/> | <input checked="" type="checkbox"/> | <input type="checkbox"/> |

IV. BIOLOGICAL RESOURCES. Would the project:

- | | | | | |
|---|--------------------------|--------------------------|--------------------------|-------------------------------------|
| a. Have a substantial adverse effect, either directly or through habitat modification, on any species identified as a candidate, sensitive, or special status species in local or regional plans, policies, or regulations by the California Department of Fish and Wildlife or U.S. Fish and Wildlife Service? | <input type="checkbox"/> | <input type="checkbox"/> | <input type="checkbox"/> | <input checked="" type="checkbox"/> |
| b. Have a substantial adverse effect on any riparian habitat or other sensitive natural community identified in the City or regional plans, policies, or regulations or by the California Department of Fish and Wildlife or U.S. Fish and Wildlife Service? | <input type="checkbox"/> | <input type="checkbox"/> | <input type="checkbox"/> | <input checked="" type="checkbox"/> |
| c. Have a substantial adverse effect on federally protected wetlands as defined by Section 404 of the Clean Water Act (including, but not limited to, marsh, vernal pool, coastal, etc.) through direct removal, filling, hydrological interruption, or other means? | <input type="checkbox"/> | <input type="checkbox"/> | <input type="checkbox"/> | <input checked="" type="checkbox"/> |
| d. Interfere substantially with the movement of any native resident or migratory fish or wildlife species or with established native resident or migratory wildlife corridors, or impede the use of native wildlife nursery sites? | <input type="checkbox"/> | <input type="checkbox"/> | <input type="checkbox"/> | <input checked="" type="checkbox"/> |
| e. Conflict with any local policies or ordinances protecting biological resources, such as tree preservation policy or ordinance (e.g., oak trees or California walnut woodlands)? | <input type="checkbox"/> | <input type="checkbox"/> | <input type="checkbox"/> | <input checked="" type="checkbox"/> |
| f. Conflict with the provisions of an adopted Habitat Conservation Plan, Natural Community Conservation Plan, or other approved local, regional, or state habitat conservation plan? | <input type="checkbox"/> | <input type="checkbox"/> | <input type="checkbox"/> | <input checked="" type="checkbox"/> |

	Potentially Significant Impact	Potentially Significant Unless Mitigation Incorporated	Less Than Significant Impact	No Impact
V. CULTURAL RESOURCES: Would the project:				
a. Cause a substantial adverse change in significance of a historical resource as defined in State CEQA §15064.5?	<input type="checkbox"/>	<input type="checkbox"/>	<input type="checkbox"/>	<input checked="" type="checkbox"/>
b. Cause a substantial adverse change in significance of an archaeological resource pursuant to State CEQA §15064.5?	<input type="checkbox"/>	<input type="checkbox"/>	<input type="checkbox"/>	<input checked="" type="checkbox"/>
c. Directly or indirectly destroy a unique paleontological resource or site or unique geologic feature?	<input type="checkbox"/>	<input type="checkbox"/>	<input type="checkbox"/>	<input checked="" type="checkbox"/>
d. Disturb any human remains, including those interred outside of formal cemeteries?	<input type="checkbox"/>	<input type="checkbox"/>	<input type="checkbox"/>	<input checked="" type="checkbox"/>
VI. GEOLOGY AND SOILS. Would the project:				
a. Expose people or structures to potential substantial adverse effects, including the risk of loss, injury or death involving:				
i. Rupture of a known earthquake fault, as delineated on the most recent Alquist-Priolo Earthquake Fault Zoning Map issued by the State Geologist for the area or based on other substantial evidence of a known fault? Refer to Division of Mines and Geology Special Publication 42.	<input type="checkbox"/>	<input type="checkbox"/>	<input checked="" type="checkbox"/>	<input type="checkbox"/>
ii. Strong seismic ground shaking?	<input type="checkbox"/>	<input type="checkbox"/>	<input checked="" type="checkbox"/>	<input type="checkbox"/>
iii. Seismic-related ground failure, including liquefaction?	<input type="checkbox"/>	<input type="checkbox"/>	<input checked="" type="checkbox"/>	<input type="checkbox"/>
iv. Landslides?	<input type="checkbox"/>	<input type="checkbox"/>	<input type="checkbox"/>	<input checked="" type="checkbox"/>
b. Result in substantial soil erosion or the loss of topsoil?	<input type="checkbox"/>	<input type="checkbox"/>	<input checked="" type="checkbox"/>	<input type="checkbox"/>
c. Be located on a geologic unit or soil that is unstable, or that would become unstable as a result of the project, and potentially result in on- or off-site landslide, lateral spreading, subsidence, liquefaction, or collapse?	<input type="checkbox"/>	<input type="checkbox"/>	<input checked="" type="checkbox"/>	<input type="checkbox"/>
d. Be located on expansive soil, as defined in Table 18-1-B of the Los Angeles Building Code (2002), creating substantial risks to life or property?	<input type="checkbox"/>	<input type="checkbox"/>	<input checked="" type="checkbox"/>	<input type="checkbox"/>
e. Have soils incapable of adequately supporting the use of septic tanks or alternative wastewater disposal systems where sewers are not available for the disposal of wastewater?	<input type="checkbox"/>	<input type="checkbox"/>	<input type="checkbox"/>	<input checked="" type="checkbox"/>
VII. GREENHOUSE GAS EMISSIONS. Would the project:				
a. Generate greenhouse gas emissions, either directly or indirectly, that may have a significant impact on the environment?	<input type="checkbox"/>	<input type="checkbox"/>	<input checked="" type="checkbox"/>	<input type="checkbox"/>
b. Conflict with an applicable plan, policy or regulation adopted for the purpose of reducing the emissions of greenhouse gases?	<input type="checkbox"/>	<input type="checkbox"/>	<input checked="" type="checkbox"/>	<input type="checkbox"/>
VIII. HAZARDS AND HAZARDOUS MATERIALS. Would the project:				
a. Create a significant hazard to the public or the environment through the routine transport, use, or disposal of hazardous materials?	<input type="checkbox"/>	<input type="checkbox"/>	<input checked="" type="checkbox"/>	<input type="checkbox"/>

	Potentially Significant Impact	Potentially Significant Unless Mitigation Incorporated	Less Than Significant Impact	No Impact
b. Create a significant hazard to the public or the environment through reasonably foreseeable upset and accident conditions involving the release of hazardous materials into the environment?	<input type="checkbox"/>	<input type="checkbox"/>	<input checked="" type="checkbox"/>	<input type="checkbox"/>
c. Emit hazardous emissions or handle hazardous or acutely hazardous materials, substances, or waste within one-quarter mile of an existing or proposed school?	<input type="checkbox"/>	<input type="checkbox"/>	<input type="checkbox"/>	<input checked="" type="checkbox"/>
d. Be located on a site which is included on a list of hazardous materials sites compiled pursuant to Government Code Section 65962.5 and, as a result, would it create a significant hazard to the public or the environment?	<input type="checkbox"/>	<input type="checkbox"/>	<input checked="" type="checkbox"/>	<input type="checkbox"/>
e. For a project located within an airport land use plan or, where such a plan has not been adopted, within two miles of a public airport or public use airport, would the project result in a safety hazard for people residing or working in the project area?	<input type="checkbox"/>	<input type="checkbox"/>	<input checked="" type="checkbox"/>	<input type="checkbox"/>
f. For a project within the vicinity of a private airstrip, would the project result in a safety hazard for the people residing or working in the project area?	<input type="checkbox"/>	<input type="checkbox"/>	<input type="checkbox"/>	<input checked="" type="checkbox"/>
g. Impair implementation of or physically interfere with an adopted emergency response plan or emergency evacuation plan?	<input type="checkbox"/>	<input type="checkbox"/>	<input checked="" type="checkbox"/>	<input type="checkbox"/>
h. Expose people or structures to a significant risk of loss, injury or death involving wildland fires, including where wildlands are adjacent to urbanized areas or where residences are intermixed with wildlands?	<input type="checkbox"/>	<input type="checkbox"/>	<input type="checkbox"/>	<input checked="" type="checkbox"/>

IX. HYDROLOGY AND WATER QUALITY. Would the project:

a. Violate any water quality standards or waste discharge requirements?	<input type="checkbox"/>	<input type="checkbox"/>	<input checked="" type="checkbox"/>	<input type="checkbox"/>
b. Substantially deplete groundwater supplies or interfere substantially with groundwater recharge such that there would be a net deficit in aquifer volume or a lowering of the local groundwater table level (e.g., the production rate of pre-existing nearby wells would drop to a level which would not support existing land uses or planned land uses for which permits have been granted)?	<input type="checkbox"/>	<input type="checkbox"/>	<input type="checkbox"/>	<input checked="" type="checkbox"/>
c. Substantially alter the existing drainage pattern of the site or area, including through the alteration of the course of a stream or river, in a manner which would result in substantial erosion or siltation on- or off-site?	<input type="checkbox"/>	<input type="checkbox"/>	<input checked="" type="checkbox"/>	<input type="checkbox"/>
d. Substantially alter the existing drainage pattern of the site or area, including through the alteration of the course of a stream or river, or substantially increase the rate or amount of surface runoff in a manner which would result in flooding on- or off-site?	<input type="checkbox"/>	<input type="checkbox"/>	<input checked="" type="checkbox"/>	<input type="checkbox"/>
e. Create or contribute runoff water which would exceed the capacity of existing or planned stormwater drainage systems or	<input type="checkbox"/>	<input type="checkbox"/>	<input checked="" type="checkbox"/>	<input type="checkbox"/>

	Potentially Significant Impact	Potentially Significant Unless Mitigation Incorporated	Less Than Significant Impact	No Impact
provide substantial additional sources of polluted runoff?				
f. Otherwise substantially degrade water quality?	<input type="checkbox"/>	<input type="checkbox"/>	<input checked="" type="checkbox"/>	<input type="checkbox"/>
g. Place housing within a 100-year flood hazard area as mapped on a federal Flood Hazard Boundary or Flood Insurance Rate Map or other flood hazard delineation map?	<input type="checkbox"/>	<input type="checkbox"/>	<input type="checkbox"/>	<input checked="" type="checkbox"/>
h. Place within a 100-year flood hazard area structures which would impede or redirect flood flows?	<input type="checkbox"/>	<input type="checkbox"/>	<input type="checkbox"/>	<input checked="" type="checkbox"/>
i. Expose people or structures to a significant risk of loss, injury or death involving flooding, including flooding as a result of the failure of a levee or dam?	<input type="checkbox"/>	<input type="checkbox"/>	<input type="checkbox"/>	<input checked="" type="checkbox"/>
j. Inundation by seiche, tsunami, or mudflow?	<input type="checkbox"/>	<input type="checkbox"/>	<input type="checkbox"/>	<input checked="" type="checkbox"/>
X. LAND USE AND PLANNING. Would the project:				
a. Physically divide an established community?	<input type="checkbox"/>	<input type="checkbox"/>	<input type="checkbox"/>	<input checked="" type="checkbox"/>
b. Conflict with applicable land use plan, policy or regulation of an agency with jurisdiction over the project (including but not limited to the general plan, specific plan, local coastal program, or zoning ordinance) adopted for the purpose of avoiding or mitigating an environmental effect?	<input type="checkbox"/>	<input type="checkbox"/>	<input type="checkbox"/>	<input checked="" type="checkbox"/>
c. Conflict with any applicable habitat conservation plan or natural community conservation plan?	<input type="checkbox"/>	<input type="checkbox"/>	<input type="checkbox"/>	<input checked="" type="checkbox"/>
XI. MINERAL RESOURCES. Would the project:				
a. Result in the loss of availability of a known mineral resource that would be of value to the region and the residents of the state?	<input type="checkbox"/>	<input type="checkbox"/>	<input type="checkbox"/>	<input checked="" type="checkbox"/>
b. Result in the loss of availability of a locally-important mineral resource recovery site delineated on a local general plan, specific plan, or other land use plan?	<input type="checkbox"/>	<input type="checkbox"/>	<input type="checkbox"/>	<input checked="" type="checkbox"/>
XII. NOISE. Would the project result in:				
a. Exposure of persons to or generation of noise levels in excess of standards established in the local general plan or noise ordinance, or applicable standards of other agencies?	<input type="checkbox"/>	<input type="checkbox"/>	<input checked="" type="checkbox"/>	<input type="checkbox"/>
b. Exposure of persons to or generation of excessive groundborne vibration or groundborne noise levels?	<input type="checkbox"/>	<input type="checkbox"/>	<input checked="" type="checkbox"/>	<input type="checkbox"/>
c. A substantial permanent increase in ambient noise levels in the project vicinity above levels existing without the project?	<input type="checkbox"/>	<input type="checkbox"/>	<input checked="" type="checkbox"/>	<input type="checkbox"/>
d. A substantial temporary or periodic increase in ambient noise levels in the project vicinity above levels existing without the project?	<input type="checkbox"/>	<input type="checkbox"/>	<input checked="" type="checkbox"/>	<input type="checkbox"/>
e. For a project located within an airport land use plan or, where such a plan has not been adopted, within two miles of a public airport or public use airport, would the project expose people residing or working in the project area to excessive noise levels?	<input type="checkbox"/>	<input type="checkbox"/>	<input type="checkbox"/>	<input checked="" type="checkbox"/>

	Potentially Significant Impact	Potentially Significant Unless Mitigation Incorporated	Less Than Significant Impact	No Impact
f. For a project within the vicinity of a private airstrip, would the project expose people residing or working in the project area to excessive noise levels?	<input type="checkbox"/>	<input type="checkbox"/>	<input type="checkbox"/>	<input checked="" type="checkbox"/>

XIII. POPULATION AND HOUSING. Would the project:

a. Induce substantial population growth in an area either directly (for example, by proposing new homes and businesses) or indirectly (for example, through extension of roads or other infrastructure)?	<input type="checkbox"/>	<input type="checkbox"/>	<input type="checkbox"/>	<input checked="" type="checkbox"/>
b. Displace substantial numbers of existing housing necessitating the construction of replacement housing elsewhere?	<input type="checkbox"/>	<input type="checkbox"/>	<input type="checkbox"/>	<input checked="" type="checkbox"/>
c. Displace substantial numbers of people necessitating the construction of replacement housing elsewhere?	<input type="checkbox"/>	<input type="checkbox"/>	<input type="checkbox"/>	<input checked="" type="checkbox"/>

XIV. PUBLIC SERVICES. Would the project result in substantial adverse physical impacts associated with the provision of new or physically altered governmental facilities, construction of which could cause significant environmental impacts, in order to maintain acceptable service ratios, response times or other performance objectives for any of the public services:

a. Fire protection?	<input type="checkbox"/>	<input type="checkbox"/>	<input type="checkbox"/>	<input checked="" type="checkbox"/>
b. Police protection?	<input type="checkbox"/>	<input type="checkbox"/>	<input checked="" type="checkbox"/>	<input type="checkbox"/>
c. Schools?	<input type="checkbox"/>	<input type="checkbox"/>	<input type="checkbox"/>	<input checked="" type="checkbox"/>
d. Parks?	<input type="checkbox"/>	<input type="checkbox"/>	<input type="checkbox"/>	<input checked="" type="checkbox"/>
e. Other governmental services (including roads)?	<input type="checkbox"/>	<input type="checkbox"/>	<input type="checkbox"/>	<input checked="" type="checkbox"/>

XV. RECREATION.

a. Would the project increase the use of existing neighborhood and regional parks or other recreational facilities such that substantial physical deterioration of the facility would occur or be accelerated?	<input type="checkbox"/>	<input type="checkbox"/>	<input type="checkbox"/>	<input checked="" type="checkbox"/>
b. Does the project include recreational facilities or require the construction or expansion of recreational facilities which might have an adverse physical effect on the environment?	<input type="checkbox"/>	<input type="checkbox"/>	<input type="checkbox"/>	<input checked="" type="checkbox"/>

XVI. TRANSPORTATION/TRAFFIC. Would the project:

a. Conflict with an applicable plan, ordinance or policy establishing measures of effectiveness for the performance of the circulation system, taking into account all modes of transportation including mass transit and non-motorized travel and relevant components of the circulation system, including but not limited to intersections, streets, highways and freeways, pedestrian and bicycle paths, and mass transit?	<input type="checkbox"/>	<input type="checkbox"/>	<input checked="" type="checkbox"/>	<input type="checkbox"/>
---	--------------------------	--------------------------	-------------------------------------	--------------------------

	Potentially Significant Impact	Potentially Significant Unless Mitigation Incorporated	Less Than Significant Impact	No Impact
b. Conflict with an applicable congestion management program, including, but not limited to level of service standards and travel demand measures, or other standards established by the county congestion management agency for designated roads or highways?	<input type="checkbox"/>	<input type="checkbox"/>	<input checked="" type="checkbox"/>	<input type="checkbox"/>
c. Result in a change in air traffic patterns, including either an increase in traffic levels or a change in location that results in substantial safety risks?	<input type="checkbox"/>	<input type="checkbox"/>	<input checked="" type="checkbox"/>	<input type="checkbox"/>
d. Substantially increase hazards to a design feature (e.g., sharp curves or dangerous intersections) or incompatible uses (e.g., farm equipment)?	<input type="checkbox"/>	<input type="checkbox"/>	<input checked="" type="checkbox"/>	<input type="checkbox"/>
e. Result in inadequate emergency access?	<input type="checkbox"/>	<input type="checkbox"/>	<input checked="" type="checkbox"/>	<input type="checkbox"/>
f. Conflict with adopted policies, plans, or programs regarding public transit, bicycle, or pedestrian facilities, or otherwise decrease the performance or safety of such facilities?	<input type="checkbox"/>	<input type="checkbox"/>	<input type="checkbox"/>	<input checked="" type="checkbox"/>

XVII. UTILITIES AND SERVICE SYSTEMS. Would the project:

a. Exceed wastewater treatment requirements of the applicable Regional Water Quality Control Board?	<input type="checkbox"/>	<input type="checkbox"/>	<input type="checkbox"/>	<input checked="" type="checkbox"/>
b. Require or result in the construction of new water or wastewater treatment facilities or expansion of existing facilities, the construction of which could cause significant environmental effects?	<input type="checkbox"/>	<input type="checkbox"/>	<input type="checkbox"/>	<input checked="" type="checkbox"/>
c. Require or result in the construction of new stormwater drainage facilities or expansion of existing facilities, the construction of which could cause significant environmental effects?	<input type="checkbox"/>	<input type="checkbox"/>	<input type="checkbox"/>	<input checked="" type="checkbox"/>
d. Have sufficient water supplies available to serve the project from existing entitlements and resources, or are new or expanded entitlements needed?	<input type="checkbox"/>	<input type="checkbox"/>	<input type="checkbox"/>	<input checked="" type="checkbox"/>
e. Result in a determination by the wastewater treatment provider which serves or may serve the project that it has adequate capacity to serve the project's projected demand in addition to the provider's existing commitments?	<input type="checkbox"/>	<input type="checkbox"/>	<input type="checkbox"/>	<input checked="" type="checkbox"/>
f. Be served by a landfill with sufficient permitted capacity to accommodate the project's solid waste disposal needs?	<input type="checkbox"/>	<input type="checkbox"/>	<input checked="" type="checkbox"/>	<input type="checkbox"/>
g. Comply with federal, state, and local statutes and regulations related to solid waste?	<input type="checkbox"/>	<input type="checkbox"/>	<input checked="" type="checkbox"/>	<input type="checkbox"/>

XVIII. MANDATORY FINDINGS OF SIGNIFICANCE.

- a. Does the project have the potential to degrade the quality of the environment, substantially reduce the habitat of fish or wildlife species, cause a fish or wildlife population to drop below self-sustaining levels, threaten to eliminate a plant or animal community, reduce the number or restrict the range of a rare or endangered plant or animal or eliminate important examples of the major periods of California history or prehistory?
- b. Does the project have impacts which are individually limited, but cumulatively considerable? ("Cumulatively considerable" means that the incremental effects of a project are considerable when viewed in connection with the effects of past projects, the effects of other current projects, and the effects of probable future projects).
- c. Does the project have environmental effects which would cause substantial adverse effects on human beings, either directly or indirectly?



DISCUSSION OF THE ENVIRONMENTAL EVALUATION (Attach additional sheets if necessary)

(See Attachment B)

ATTACHMENT A PROJECT DESCRIPTION

1.0 PURPOSE OF INITIAL STUDY

The general purpose of this Initial Study is to determine if the Los Angeles International Airport (LAX) Terminal 1 Modernization Project (“proposed project”) may have a significant effect on the environment and to serve as an informational document for the public and the decision-makers.

The Los Angeles World Airports (LAWA) has completed the following Initial Study for the proposed project in accordance with the California Environmental Quality Act or CEQA (Section 21000 et seq., California Public Resources Code), implementing State CEQA Guidelines (Section 15000 et seq. Title 14, California Code of Regulations), and L.A. CEQA Thresholds Guide (2006). The Initial Study for the proposed project was prepared in accordance with the requirements set forth in Section 15063 of the State CEQA Guidelines. As determined in this Initial Study and as further described in Attachment B, Explanation of Checklist Determinations, there is no substantial evidence that the proposed project may have a significant effect on the environment. Therefore, in accordance with Section 15070 of the State CEQA Guidelines, a Negative Declaration is hereby proposed.

This Draft Initial Study/Negative Declaration (IS/ND) will be circulated for review and comment by the public and other interested parties, agencies, and organizations for 20 days in accordance with Section 15073 of the State CEQA Guidelines. All comments or questions about the Draft IS/ND should be addressed to the following individual:

Mr. Christopher Koontz
Los Angeles World Airports
One World Way West, 2nd Floor
Los Angeles, CA 90045
(800) 919-3766

Upon completion of the public comment period, a Final IS/ND will be prepared that provides written responses to comments received on the Draft IS/ND. These comments and their responses will be included in the Final IS/ND for consideration by LAWA.

2.0 INTRODUCTION

LAWA and Southwest Airlines (SWA) propose the renovation and modernization of Terminal 1 at LAX (“proposed project”). The main purposes of the proposed project are to improve the passenger level of service within the terminal; improve the efficiency of security screening, baggage processing and inspection, curbside operations, and aircraft operations; and modernize the interior and exterior appearance of the terminal to benefit the overall look of the Central Terminal Area (CTA).

Southwest Airlines is responsible for implementation of the modernization program and upon successful completion of the program elements, the improvements would be acquired from the airline by the City of Los Angeles.

3.0 PROJECT LOCATION AND SURROUNDING USES

Regional Setting

As shown in Figure 1, Regional Location Map, the project site is located within the City of Los Angeles, at LAX on LAWA property. The project site is located within the LAX Plan area of the City of Los Angeles, which is in the County of Los Angeles. LAX is the primary airport for the greater Los Angeles area, encompassing approximately 3,650 acres, and is situated at the western edge of the City of Los Angeles. In 2013, LAX was the world's sixth busiest passenger airport, serving approximately 66.6 million annual passengers.¹

In the LAX vicinity, the community of Westchester is located to the north, the City of El Segundo is to the south, the City of Inglewood and unincorporated portions of Los Angeles County are to the east, and the Pacific Ocean lies to the west. Regional access to LAX is provided by Interstate 105, which runs east-west and is located adjacent to LAX on the south, and the San Diego Freeway (Interstate 405), which runs north-south and is located east of LAX. The main arterial streets serving LAX include Sepulveda Boulevard, Century Boulevard, Imperial Highway and Lincoln Boulevard.

Local Setting and Land Uses

LAX has nine passenger terminals arranged in a U-shape with a two-level layout separating departures and arrivals. The two-level airport roadway network is accessed from the following three off-airport roadways: Century Boulevard, Sepulveda Boulevard, and 96th Street Bridge/Sky Way. Each of these roadways provides vehicular access to both the departures (upper) level or the arrivals (lower) level curbsides and roadways. Airport access from the departures level to the arrivals level is provided via a recirculation ramp located at the eastern end of the CTA and a ramp at the western end of Center Way, connecting to West Way. Access from the arrivals level to the departures level is provided via the ramp at the western end of Center Way, connecting to West Way (upper level).

Terminal 1 is the first terminal that is accessed upon entry to the CTA. The terminal is predominantly used by Southwest Airlines, which operates at 12 of the 15 gates at the terminal. US Airways operated at the three remaining gates until its recent relocation to Terminal 3; those gates are now available for other airlines. The southern (landside) area associated with Terminal 1 is located along the northeastern portion of the CTA's U-shaped roadway (World Way). The northern (airside) area associated with the project site is bounded by a common airside access system comprised of Taxilane D and a service road to the north. Terminal 1 is the largest of all the terminals in terms of number of gates and is the busiest terminal for regional flights.

4.0 EXISTING FACILITIES

Terminal 1 was built in 1984. It is the largest of all the terminals at LAX in terms of number of gates (with the exception of the newly upgraded Tom Bradley International Terminal), and the busiest terminal for regional flights. Terminal 1 is approximately 360,000 square feet (SF) and consists of a double-loaded (double-sided) pier concourse with 15 gates supported by a ticketing area and baggage claim facility.

¹ City of Los Angeles, Los Angeles World Airports, Statistics – Ten Year Summary – Passengers, Available: http://lawa.org/welcome_LAX.aspx?id=800, accessed February 13, 2014.



**LAX Terminal 1
Modernization Project**

**Regional and Project
Location Map**

Figure
1

This page intentionally left blank.

Existing Operations

Until very recently, Terminal 1 has been occupied by SWA and US Airways. US Airways has occupied the westerly portion of the terminal arrivals and departures levels and three of the 15 gates. SWA operates out of the easterly portion of the terminal and the remaining 12 gates. SWA's operations have accounted for approximately 85 percent of the passenger activity at Terminal 1. Based on their August 2012 flight schedule, SWA has approximately 134 daily departures, generating approximately 19,200 daily departing seats. In total, 9,651,270 passengers traveled through Terminal 1 in 2013, more than any other terminal at LAX.² US Airways relocated their operations to Terminal 3 in mid-February 2014. The three gates and related passenger facilities formerly used by US Airways are now used by other airlines.

Existing Terminal

In general, a terminal consists of a multi-level "Ticketing Building" (which is the area closest to World Way, and consists of functions such as ticketing/passenger check-in, passenger security screening, checked bag screening, domestic baggage claim, and operations support) and a "Concourse" (which is the portion of the terminal closest to the airfield, and consists of components such as holdrooms, concessions, baggage make-up, and operations support).

At LAX, the Terminal 1 Ticketing Building is arranged on three levels. The first/bottom level is the arrivals level, the second level is the ticketing/departures level, and the third (and mezzanine) level houses security screening. Each level includes airline customer service and other support offices. Although not an enclosed floor, the mechanical rooms are on the roof. The Concourse itself only has two levels, and is offset from the Ticketing Building, with the lower level (i.e., ramp level) located between the first and second levels of the Ticketing Building, and the upper level (i.e., concourse level) located between the second and third levels of the Ticketing Building.

The Ticketing Building arrivals level includes four baggage claim devices – two on the easterly side used by SWA and two on the westerly side formerly used by US Airways. The easterly and westerly sides are separated by a lobby area with an interior escalator leading down from the concourse level. There are also escalators parallel to World Way that lead down from the ticketing level. The Ticketing Building departures level includes the ticketing lobbies. SWA ticketing lobbies at Terminal 1 are located on the easterly end, while the westerly ticketing lobbies (formerly used by US Airways) are available for other airlines. Ticketing facilities include curbside counters, conventional counters and self-service kiosks. Airline ticket offices are located directly behind the ticket counters. Explosive Detection Systems (EDS) equipment is also located in the ticketing lobbies. The mezzanine level of the Ticketing Building includes the Security Screening Check Point (SSCP), which consists of two separate facilities with a total of 12 lanes, as well as administrative offices and holdrooms for Gates 1 and 2.

The Concourse lower (ramp) level is used to support aircraft and building operations, including outbound baggage make-up, ramp operations, aircraft maintenance, and administrative and operational support uses. The baggage make-up is located in an area that is covered but not enclosed; this area has a roof but does not have walls and is not considered to be building area for purposes of calculating floor-to-area ratio (FAR) or for zoning building code compliance. The upper concourse level consists

² City of Los Angeles, Los Angeles World Airports, Passenger Traffic Comparison by Terminal, Los Angeles International Airport, Available: <http://lawa.org/uploadedfiles/LAX/statistics/ptcom-1213.pdf>, accessed February 3, 2014.

of holdrooms (i.e., passenger waiting areas) and concessions, which are arranged along the interior of the concourse.

Terminal 1 has not materially changed in appearance since it was constructed 30 years ago. An evaluation of Terminal 1 conditions conducted by LAWA in 2011 determined that many portions of the terminal are showing signs of wear and tear. Available space for concessions is not considered to be adequate to provide a high level of amenities and passenger service. Moreover, the arrangement of the terminal functions, including ticketing counters, passenger security screening, and baggage claim, do not reflect the balance of activity among the tenant airlines, and result in long lines and inefficient use of the curb, as discussed further in the following section. Additionally, with federal security requirements that were imposed under the Aviation and Transportation Security Act following the events of September 11, 2001, and with increasing passenger and vehicle traffic, Terminal 1 currently operates inefficiently as described below.

LAWA, in cooperation with the federal Transportation Security Administration (TSA) and tenant airlines, has met a series of mandated deadlines for implementing federal security requirements. As security needs have increased over time, the amount and complexity of screening equipment has grown to include more sophisticated (and larger) x-ray equipment, which requires additional space. In addition, as the passenger screening process becomes more complex and time consuming, the need for more processing lanes has increased. The current SSCP area does not provide enough space to accommodate the evolving federal security requirements and an adequate processing area. The space constraints have resulted in placement of EDS equipment in the ticketing lobbies and the queuing of passengers outside along the departures curb for the passenger screening process during peak periods.

Existing Curbside

Terminal 1 occupies approximately 560 lineal feet (LF) of curb frontage along World Way out of approximately 5,800 LF available in the CTA. The departures level curb and roadway at Terminal 1 consists of four traffic lanes and a single loading/unloading lane of sufficient width to accommodate two vehicles.

The arrivals level curb and roadway is divided by a center median necessitated by the columns supporting the departures level roadway. The outer portion consists of five traffic lanes (typical), a single loading/unloading lane of sufficient width to accommodate courtesy buses, and a left turn lane into the parking garage and recirculation road. The inner portion of the arrivals level roadway has two lanes. The innermost lane is sufficiently wide to be used as a loading/unloading lane and a mixed use loading/unloading lane and traffic lane. The outer lane is a traffic lane. The innermost lane also functions as a taxi stand on the east end of Terminal 1. In addition, the intersection of Sky Way and World Way is at the east end of Terminal 1. Located east of the intersection is a commercial vehicle staging area.

As noted above, the eastern half of Terminal 1 is occupied by Southwest Airlines, which handles approximately 85 percent of the terminal's passengers. The SWA Skycap is located within the sidewalk in front of the eastern portion of the building (the portion closest to Sky Way). As a result, short segment of World Way North west of Sky Way experiences a high volume of vehicles driving to the curb immediately after passing through the Sky Way/World Way North intersection. With insufficient merge distance, vehicular congestion often results, which regularly compromises safety and throughput rate. Further, the departures level curb experiences extensive congestion at periods throughout the day. The congestion tends to occur at the east end of Terminal 1, in front of the SWA

ticket lobby and can impact the Sky Way/World Way North intersection, particularly the right hand turning movement from Sky Way. The curb west of the ticket lobby is typically less congested.

Similar conditions exist on the arrivals level. SWA uses the east baggage claim and, as a result, the majority of the passengers using the terminal currently exit through doors located in the easternmost half of the building. From these doors, passengers access landside activities such as curbside passenger pick-up, taxis, shared ride vans, and car services located at the inner curb, and ground transportation services such as hotel, rental car, remote parking, employee, and inter-terminal shuttles, and Flyaway and charter buses located along the outer curb. Some passengers use signalized crosswalks that provide pedestrian access to Parking Structure 1 while others exit the terminal and walk east along World Way North to access vehicles parked in Park One or the hotels, offices and other businesses located along Century Boulevard. As with the departures level, the arrivals level curb has extensive congestion at certain times of the day, which tends to occur at the eastern end. The close proximity to the Sky Way/World Way North intersection creates vehicle merging activity that often results in congestion that compromises safety and throughput rate, similar to that on the upper level roadway.

5.0 STATEMENT OF PROJECT OBJECTIVES

The main purpose of the proposed project is the modernization of Terminal 1 to improve efficiency and the quality of service while meeting federal security requirements. The project would provide improvements to more efficiently accommodate existing and near-term operations at a higher level of passenger service. The specific objectives of the project are to:

- Improve passenger level of service and amenities throughout the terminal
- Meet Transportation Security Administration (TSA) requirements for security screening and provide flexible space for next generation passenger and baggage security screening functions
- Provide enhanced flexibility in gate configuration to accommodate planned migration by Southwest Airlines to larger aircraft fleet
- Improve peak hour curb utilization adjacent to the terminal, eliminate passenger queuing outside the terminal, and reduce traffic congestion by shifting curbside, ticketing, and baggage claim functions
- Modernize and upgrade the facility interior and exterior to enhance the facility and meet current building codes

6.0 DESCRIPTION OF THE PROPOSED PROJECT

Background

As noted above, other than minor improvements, Terminal 1 has not been materially changed in the last 30 years and does not provide comparable standards, amenities, and aesthetics realized at other international and national airports around the world. As described in Section 4.0, the existing arrangement of terminal uses results in inefficient operations and a compromised level of passenger service. In addition, anticipated changes in the SWA aircraft fleet will lead to further inefficiencies in aircraft operations at Terminal 1.

SWA currently operates three types of aircraft at LAX, Boeing 737-300s, 737-700s and 737-800s. The smallest of these, the 737-300, is no longer being manufactured by Boeing and SWA's use of this aircraft will eventually be discontinued, while the use of the largest aircraft, the 737-800, is planned to increase. This change in fleet mix will occur with or without implementation of the proposed project. In addition, passenger activity at Terminal 1 is projected to increase in the future as a result of natural growth. The existing terminal can accommodate the projected fleet and associated number of passengers. However, as shown in Figure 2, the majority of the gates at Terminal 1 cannot accommodate the 737-800, which would result in gating constraints and reduced flexibility, and could result in periodic flight delays. Additionally, the current inefficiencies occurring within the terminal, such as curbside queuing and security screening queuing as discussed above, as well as general congestion within holdrooms, concessions, and other spaces, would increase during peak periods.

Project Description

The purpose of this project is the modernization of Terminal 1 to enhance passenger level of service and satisfaction and meet evolving federal security requirements. The proposed project includes reconfiguration of the location of some of existing uses, modification of the gates, an increase in the square footage of the Ticketing Building primarily to accommodate the SSCP on the departures level, an increase in the square footage of the concourse level primarily to increase the area available for holdrooms, interior design and façade improvements, and upgrades to some of the building's existing mechanical systems and infrastructure. The proposed improvements would enhance security, increase the efficiency of the passenger screening process, and reduce processing time, as well as modernize and enhance the terminal. The new space would improve the passenger experience and increase the overall efficiency and level of customer service and satisfaction. Figure 3 shows a site plan of the proposed project, including the proposed building additions. Table 1 identifies the proposed building additions by area. Figure 4 provides visual simulations of proposed interior upgrades.

As noted above, aircraft operations are expected to evolve and passenger activity is projected to increase at Terminal 1 in the future with or without the project. These changes would occur in response to changes in market conditions and natural growth in passenger demand for air travel. No change in the aircraft fleet mix or operations, and no increase in the projected number of passengers served, would occur as a result of the proposed project. While the proposed project would serve to better accommodate 737-800 aircraft and would more efficiently and conveniently serve the projected number of passengers, these fleet changes and passenger growth would occur whether or not the proposed project is implemented.

As described below, with implementation of the proposed project, Terminal 1 would accommodate 14 gates, twelve of which could accommodate the 737-800. Currently, the terminal has 15 gates, three of which can accommodate 737-800 or larger aircraft as currently configured. At full capacity, the 737-800 can hold 175 passengers and the 737-300 and 737-700 can hold 143. It is anticipated that, at the time of project buildout (i.e., 2017), approximately two-thirds of the SWA aircraft fleet at LAX will consist of 737-700 aircraft and one-third of the fleet will consist of 737-800 aircraft. The proposed lease agreement between LAWA and SWA would permit another airline to operate out of Terminal 1 after the proposed project is completed. It is assumed that the other airline would use the two non-proprietary gates at the terminal and would utilize similar sized narrow body aircraft.

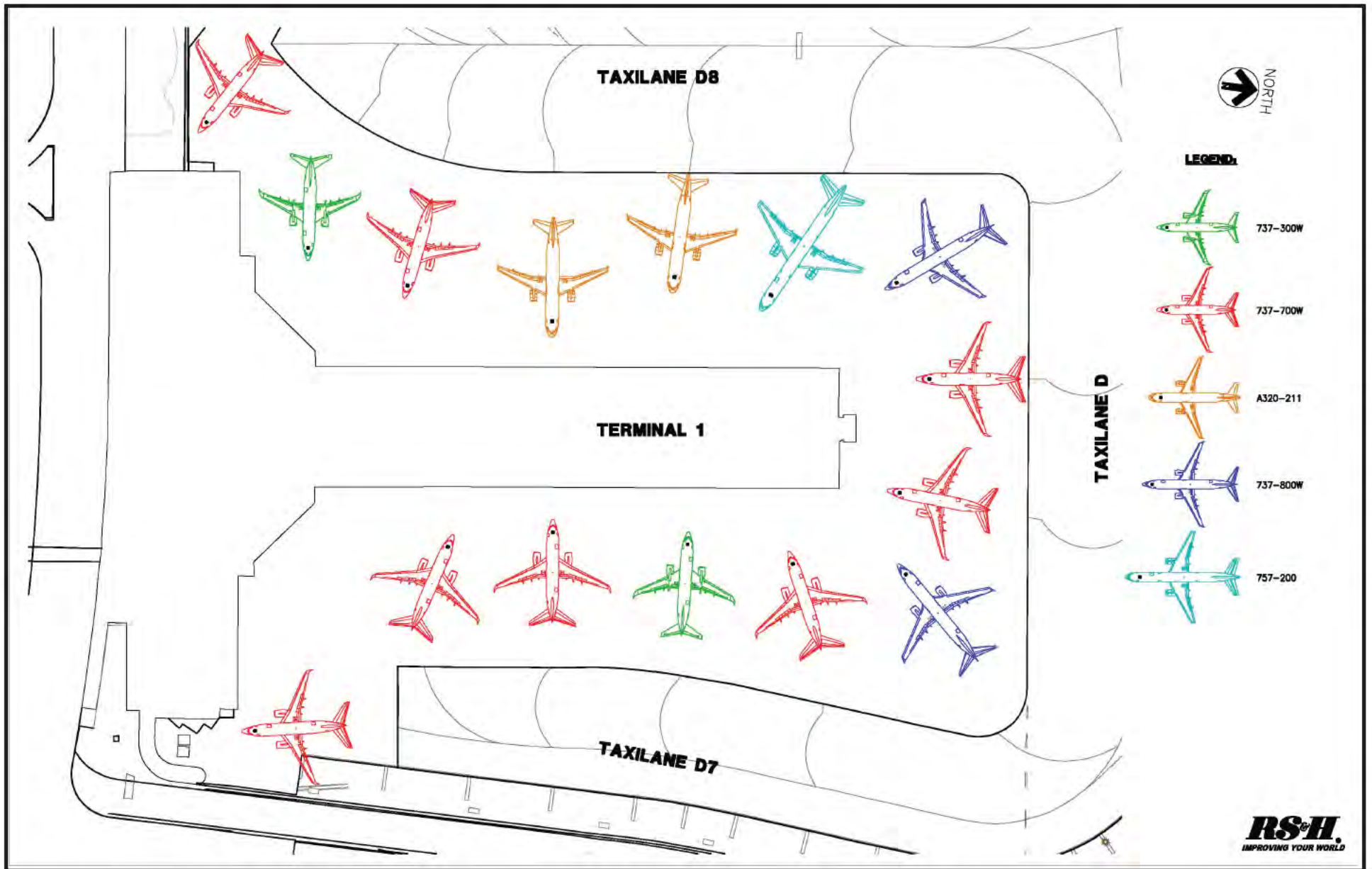

LAX Terminal 1 Modernization Project

Existing Gate Configuration

Figure 2

This page intentionally left blank.

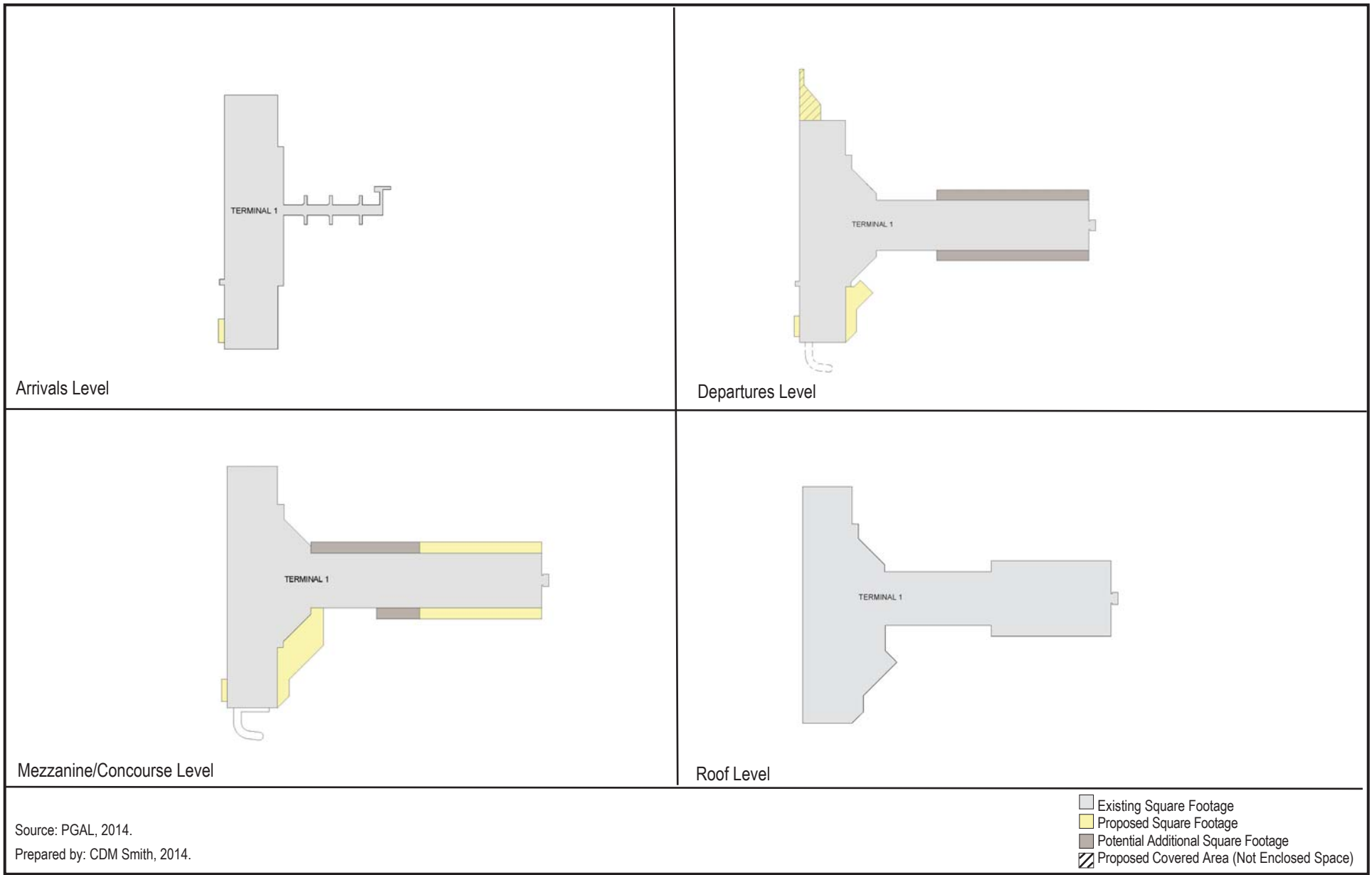

LAX Terminal 1 Modernization Project

Terminal 1 Site Plan

Figure
3

This page intentionally left blank.

Table 1									
Proposed Building Additions									
Building Area	Existing Building Area (SF)¹			New Building Area to be Added (SF)			Total Building Area with Project Implementation (SF)²		
	Enclosed Building	Not Enclosed Building³	Total	Enclosed Building	Not Enclosed Building³	Total	Enclosed Building	Not Enclosed Building³	Total
Ticketing Building									
Arrivals	72,033	0	72,033	1,000	0	1,000	73,033	0	73,033
Departures/Ticketing	49,897	0	49,897	5,720	0	5,720	55,617	0	55,617
Mezzanine	50,379	0	50,379	1,000	0	1,000	51,379	0	51,379
Roof	0	18,717 ⁴	18,717	0	1,700 ⁴	1,700	0	20,417	20,417
Concourse Building									
Ramp Level	48,304	44,697	93,001	19,320	0	19,320	67,624	44,697	112,321
Concourse	85,643	0	85,643	32,110	0	32,110	117,753	0	117,753
Total	306,256	63,414	369,670	59,150⁵	1,700	60,850	365,406	65,114	430,520
Notes:									
¹ Includes usable and non-usable (e.g., vertical circulation, utility areas, etc.) square footage.									
² Includes approximately 30,800 SF of net new area for TSA and other federally-mandated functions. Such improvements are not considered part of the project for purposes of compliance with the LAX Specific Plan.									
³ Not enclosed building space includes baggage makeup area at the ramp level that is covered but not enclosed (i.e., there is a roof but no walls), as well as mechanical penthouses on the roof.									
⁴ Consists of mechanical penthouses situated on the roof, which are not considered to be building area for purposes of calculating floor-to-area ratio (FAR) or SF for zoning/building code compliance.									
⁵ Total new building area to be added for purposes of compliance with the LAX Specific Plan is approximately 28,350 SF.									

This page intentionally left blank.



View Looking East From Ticket Lobby



View of Holdroom Area



View of Baggage Claim Area

Source: PGAL, 2014.

Prepared by: CDM Smith, 2014.



View of Concourse Looking North From Gates 3, 4 and 5

LAX Terminal 1 Modernization Project

Visual Simulations

Figure
4

This page intentionally left blank.

The increased number of gates that could accommodate the 737-800 with implementation of the proposed project would not result in an increase in the expected number of passengers at Terminal 1 over what would occur in the future without the proposed project for several reasons. In the absence of the proposed project, it is reasonably foreseeable that SWA would make adjustments to some of the gates to enable them to accommodate the larger aircraft. Such adjustments could include operational changes such as moving passenger boarding bridges to increase the space at each gate. These adjustments could be accomplished at a number of the existing gates without the need for any physical construction. In addition, the 737-800, because of the larger cabin size, has a longer turn time, which is the time required to unload an airplane after its arrival at the gate and to prepare it for departure again.³ (The minimum scheduled turn time for a 737-700 aircraft at LAX is approximately 35 minutes; the minimum scheduled turn time for a 737-800 is approximately 45 minutes.) Therefore, although the projected fleet would be able to accommodate a greater number of passengers per aircraft, with the reduction in the total number of gates at Terminal 1, and the longer turn times associated with the 737-800, the proposed project would not result in an increase in aircraft operations or passengers over conditions that are reasonably foreseeable without the project. Consequently, the proposed increase in the number of gates that could accommodate the 737-800 would increase gating flexibility and operational flexibility, but would not trigger growth in operations.

The number of workers currently employed at Terminal 1 is estimated to be 1,353 people. LAWA has projected that this will increase by approximately 203 workers to 1,556 in the future based on the projected natural growth at LAX. This increase would occur with or without implementation of the proposed project. Under the proposed project, the number of employees is likely to further increase by a small amount as a result of new concessions located at Terminal 1. Under both current and projected future conditions, employees are shuttled into the CTA from remote employee parking lots.

Specific improvements associated with the proposed project are described below.

Arrivals Level

At the arrivals level, renovations to the western half of the Ticketing Building in the area currently occupied by US Airway's baggage claim would consist of installation of a new baggage claim hall with two new baggage claim devices of increased size and capacity to accommodate anticipated demand. All arriving passengers claiming checked bags would flow through the baggage claim hall and then proceed through doors located within the western half and center of the building to access curbside activities.

Renovations to the eastern half of the building would consist of a new in-line Checked Baggage Inspection System (CBIS) in the area currently occupied by SWA's baggage claim. The new CBIS would greatly enhance the efficiency and capabilities of the TSA. The CBIS would be fully automated and located within a restricted non-public area of the terminal below the new SSCP. It would increase the efficiency of the screening process and screened bag throughput rate, while potentially reducing the number of on-the-job injuries, as well as creating a safer work environment for TSA personnel. In the southeast corner of the Ticketing Building arrivals level, 1,000 SF would be added for circulation. This addition would extend to three levels (arrivals, departures, and mezzanine), for a total of 3,000 SF, and would provide area for a relocated elevator, emergency egress stairs, and

³ The Boeing Company, The Role of Computer Simulation in Reducing Airplane Turn Time, Available: http://www.boeing.com/commercial/aeromagazine/aero_01/textonly/t01txt.html, accessed February 1, 2014.

building support functions in order to create adequate space for the SSCP. See Figure 5 for proposed modifications to the arrivals level.

Departures Level

Within the departures level of the Ticketing Building, all ticketing functions would be consolidated into the west lobby. Renovations would include new ticket counters, check-in kiosks, and checked baggage drop. The east lobby would be converted into a new 12-lane SSCP with the associated passenger queue. Sufficient SSCP queue area is planned within the terminal to eliminate the current need for passengers to queue outside during peak periods. In the southeast corner of the arrivals level, the terminal would be expanded by 1,000 SF to provide for circulation, as noted above. The terminal would also be expanded in the northerly direction between Gates 1 and 3 by approximately 13,680 SF on two levels, including the departures level and the mezzanine. On the departures level, this additional building area (4,720 SF) would provide adequate post-security screening recompose area and circulation space connecting the SSCP with the concourse and would include new stairs, escalators and elevators.

The lower (ramp) level of the Concourse Building lies 4 feet below the departures level of the Ticketing Building. Within the Concourse at the ramp level, the space would be reconfigured to accommodate support functions. In addition, the extension of the upper level of the Concourse Building would create 19,320 SF at the ramp level. Current plans are to create a covered area (with a roof but no walls) in this location to be used for parking of ground service equipment (GSE) and provisioning vehicles. However, this area may be enclosed to create new building square footage and is assumed to be enclosed in the building calculations (see Table 1). Figure 6 illustrates proposed modifications to the departures level.

Mezzanine/Concourse Level

Within the linear portion of the mezzanine/concourse level, the west mezzanine would be reconfigured to include airline administrative and ticketing offices, concessions storage, retail concessions, restrooms and a holdroom for passengers using Gate 2. The east mezzanine level would be similarly reconfigured, and would include administrative office space for third party vendors, airline administrative space, TSA office space, retail concessions, restrooms, and a holdroom for passengers using Gate 1. In the southeast corner of the mezzanine, the Ticketing Building would be expanded by 1,000 SF to provide for circulation, as noted above.

The concourse would be reconfigured to provide a coordinated approach to holdrooms and concessions (see Figure 7). Approximately 8,960 square feet would be added between Gates 1 and 3 (as noted above) and would consist of circulation space connecting the SSCP with the concourse as well as a concessions area. In addition, the concourse would be extended in both the easterly and westerly directions by approximately 25 feet on each side, as shown in Figure 3 and illustrated in Figure 8. The building area would be added between Gates 7 and 11 on the east side of the concourse, and between Gates 6 and 10 on the west side of the concourse. Additional square footage may be added on the east side of the concourse at Gate 5 and on the west side of the concourse at Gates 4A and 4B. The total amount of new area along the easterly and westerly sides of the concourse would be approximately 23,150 SF on one level. The building extension would improve the passenger level of service in the holdrooms, reduce congestion and support a new concessions program that would represent an upgrade in amenities and level of service. Figure 7 illustrates proposed modifications to the mezzanine/concourse level.

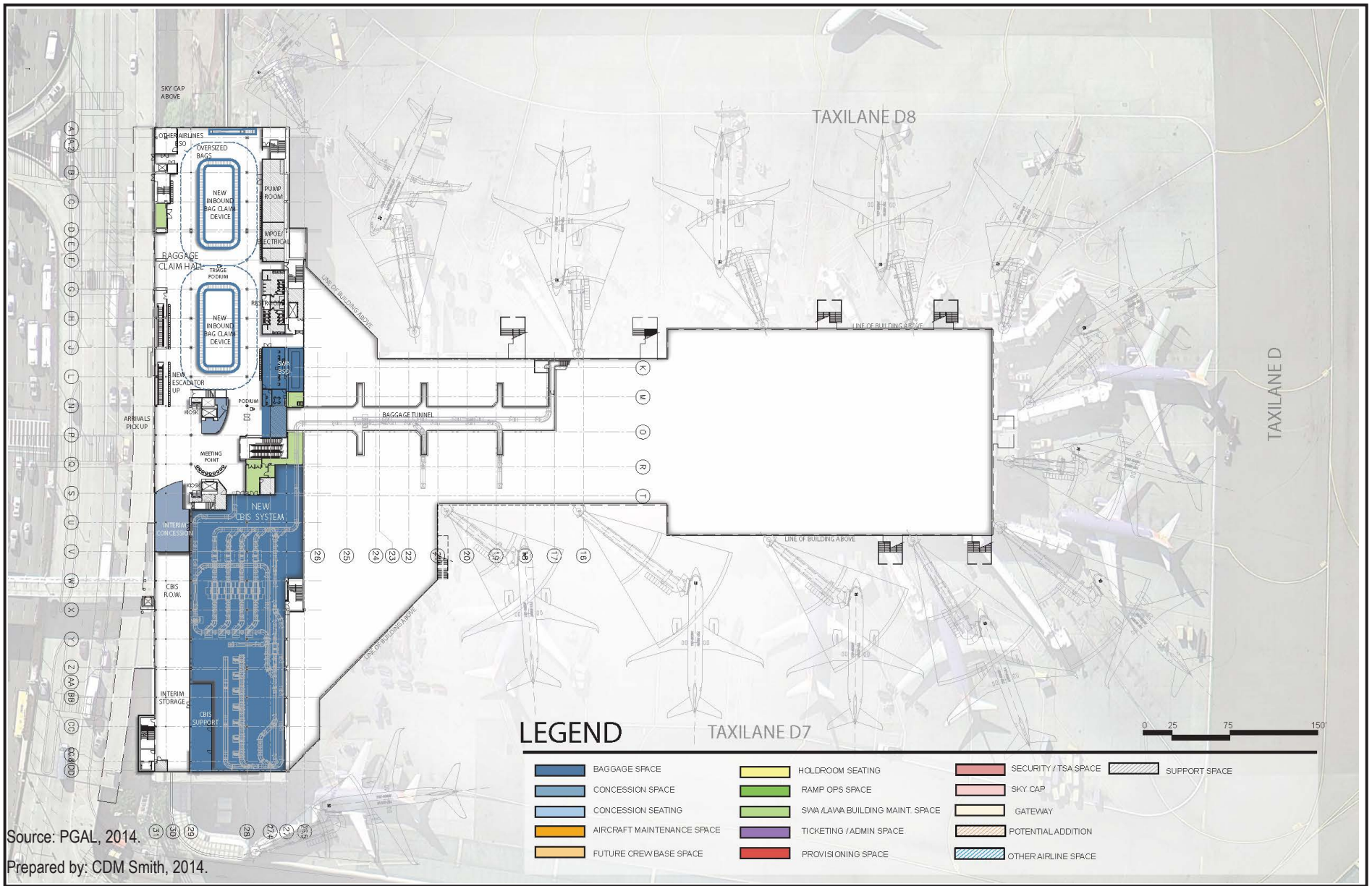

LAX Terminal 1 Modernization Project

Conceptual Arrivals Level Floor Plan

Figure 5

This page intentionally left blank.

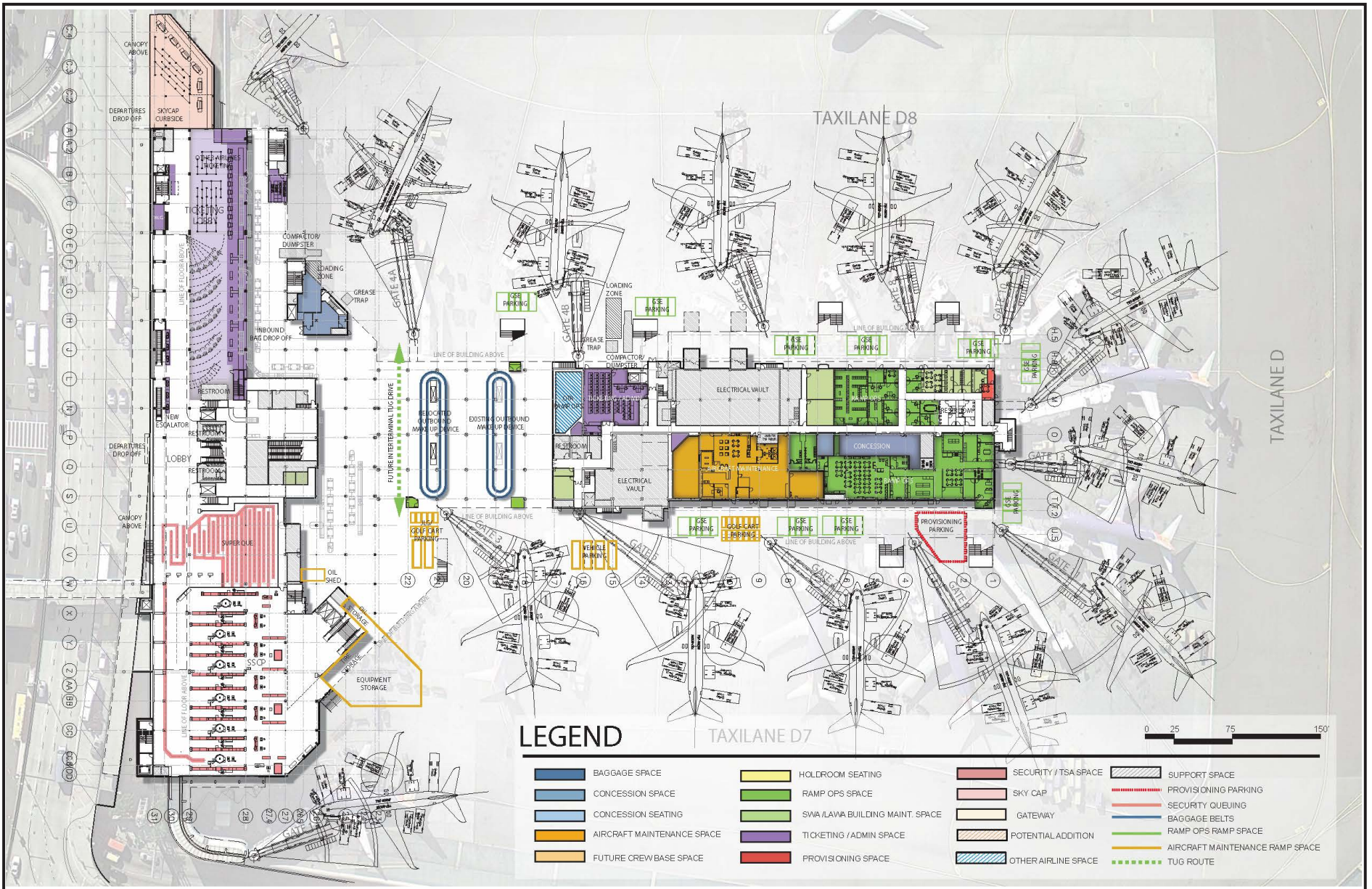

LAX Terminal 1 Modernization Project

Conceptual Departures Level Floor Plan

Figure
6

This page intentionally left blank.

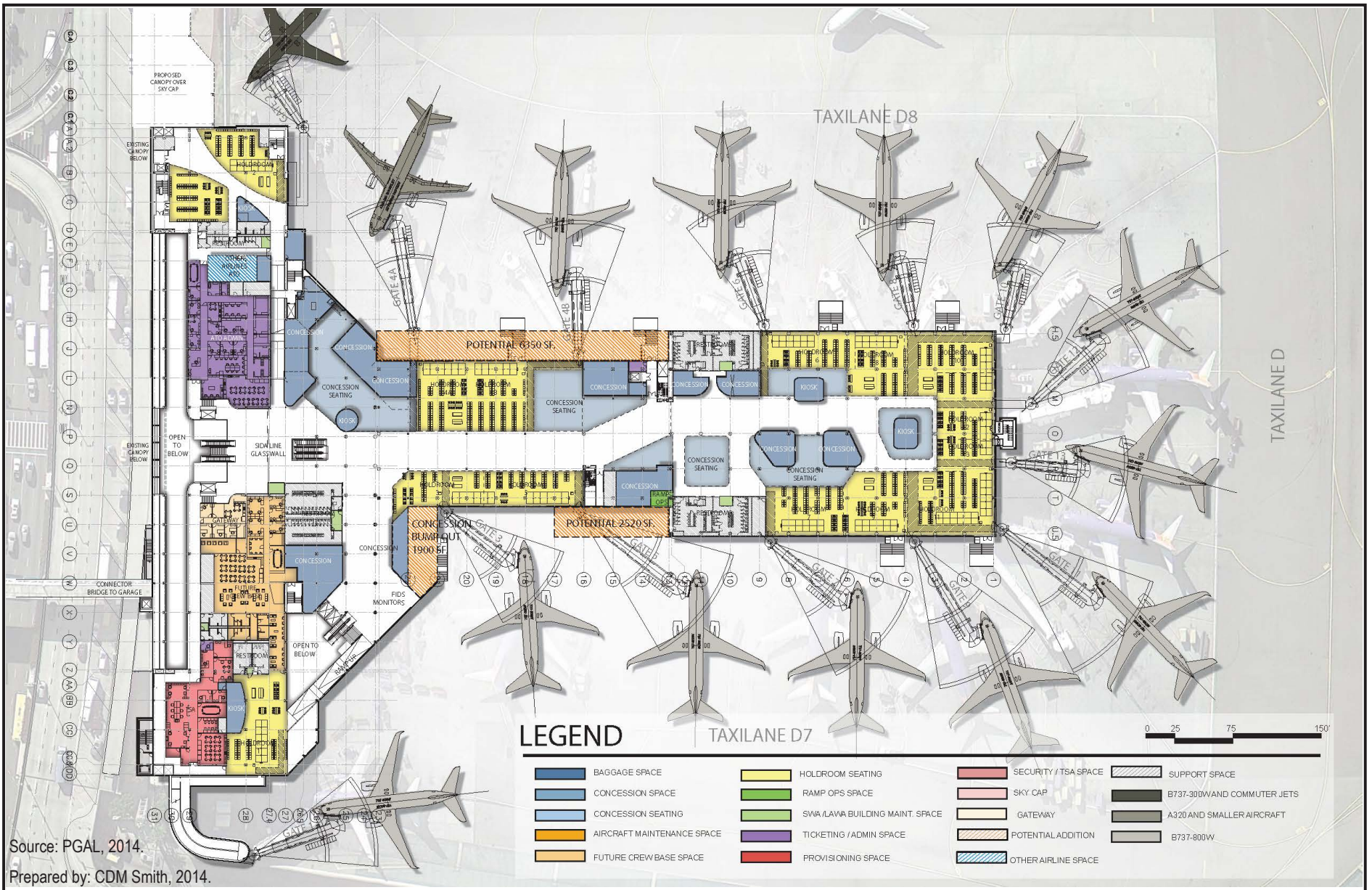

LAX Terminal 1 Modernization Project

Conceptual Mezzanine/Concourse Level Floor Plan

Figure
7

This page intentionally left blank.



Source: PGAL, 2014.

Prepared by: CDM Smith, 2014.

LAX Terminal 1 Modernization Project

Simulation of Mezzanine Building Addition

Figure
8

This page intentionally left blank.

Roof Level

At the roof level, existing mechanical penthouses would be increased in size by approximately 1,700 SF total in four locations as necessary to accommodate additional mechanical equipment needed to support the additional concourse area. The increased mechanical storage area is not included in the overall project square footage calculations. These increases would occur within the existing roof footprint.

Gate Reconfiguration

Aircraft parking would be reconfigured to accommodate 737-800s at 12 gates, including new apron paving, striping and fuel hydrant pit relocations. One gate would accommodate 737-300s, one gate would accommodate A320s, and one gate would be eliminated (i.e., 15 existing gates would be reduced to 14 new gates). The proposed gate plan is illustrated in Figure 9.

All gates would be equipped with 400 Hertz (Hz) power, pre-conditioned air, and potable water equipment. Other gate system improvements would consist of replacing all Passenger Boarding Bridges and installing new, energy efficient battery chargers capable of supporting an all-electric GSE program (although conversion of GSE to electric equipment is not part of the proposed project).

New Canopy and Façade Improvements

The proposed project would include architectural treatments to provide a more modern, aesthetically-pleasing building. At the departures level, a new canopy would be installed similar in look, materials, and functionality to the one recently constructed at the Tom Bradley International Terminal (TBIT) and new identification and way-finding signage would be provided. Additional façade improvements could include new clear glazing on the western half of the façade, cleaning of the existing precast concrete panels, and repair of the panel joints. Also under consideration is replacement of the existing horizontal sloped windows and metal panels with a perforated metal screen which would disguise the rounded top of the building and improve the overall appearance of the terminal.

Combined, the improvements planned and under consideration would give Terminal 1 an updated face which is clean, modern, and welcoming. Further, these elements would work in concert and be designed to emphasize the western half of the building as the most desirable location to stop and drop-off passengers curbside. The eastern half of the building would include architectural treatments that visually communicate “no entrance” thereby discouraging curbside drop-off activity.

Minor modifications are planned for the arrivals level and may include the replacement of identity and way-finding signage, street furniture and lighting, which would be located to emphasize passenger activity centered on the western half of the building.

Other Improvements

The proposed project would create an opportunity to improve the building’s performance during a seismic event in order to accomplish a life safety objective and increase the likelihood that occupants would be able to exit the building to a point of safety after an event. The seismic improvements would strengthen the columns of the moment frame system, as well as improve some of the beam-to-column connections. Improvements to the foundation system may also occur in the Concourse Building.

As part of the proposed project, a terminal-wide premise distribution system and paging system would be installed. This would include the construction of a new main point of entry for data and telecommunications needed to optimize the utilization of information technology within the terminal

for airline operations, customer service, and passenger convenience alike, as well as new telecommunications rooms at approximately 250-foot intervals to increase the coverage and reliability of these systems throughout the terminal.

Other improvements include replacement of the existing roofing system with a new system; installation of a new fire water loop, which would provide fire water at the required pressure in and around Terminal 1, thereby enhancing the ability of emergency responders to successfully extinguish a fire-related incident; provision of space to support a recycling program for the tenant airlines and concessionaires, including area for depositing, storing, and collecting materials for recycling; and replacement of mechanical and plumbing distribution systems.

Sustainable Design Measures

At a minimum, the proposed project would be designed to meet the requirements of CalGreen Tier 1, which would reduce energy consumption by an additional 15 percent (compared to Title 24, Part 6-2008) and potable water consumption by 30 percent through the installation of water-conserving fixtures and sub-metering of individual tenant spaces. Commissioning would be included to verify that the building systems and components meet objectives and requirements. Environmental quality would be enhanced through compliance with limits on volatile organic compounds and requirements for ventilation, air filtration, acoustical control, and noise transmission.

The project would be designed to include recycled building materials to the maximum extent possible. The minimum recycled content for the proposed project would be 10 percent of the total material costs. During construction, a minimum of 65 percent of all construction debris would be recycled.

Reconfiguration of Traffic Circulation Patterns/Curbside Use

As noted above, the proposed project would modify the locations of some of the building's existing uses, which is expected to improve the utilization of the departures and arrivals curbs and roadways immediately adjacent to the terminal and reduce the congestion that currently occurs during peak periods. Figure 10 shows the proposed modifications to the entry and curb and roadway at the departure level.

At the departures level, all Skycap functions would be relocated to a new area at the west end of the building. Skycap functions (including the associated queue) would occur north of the existing sidewalk, clearing the sidewalk of pedestrian congestion and improving safety. The new Skycap would attract vehicles dropping passengers at curbside to a location further west and away from the intersection of Sky Way and World Way North, reducing vehicle congestion and enhancing vehicular flow past Terminal 1 and through the CTA. The primary building entrance would be located in the western half of the building in conjunction with the consolidation of all ticketing functions in the west lobby. A secondary entrance (for passengers bypassing the ticket lobby) would be located at the center of the building. The existing entrances to the east lobby would be converted to emergency exits from this portion of the building. As a result of these changes, it is expected that vehicles dropping passengers at curbside would gravitate toward the new entrances and away from the dormant portions of the façade.

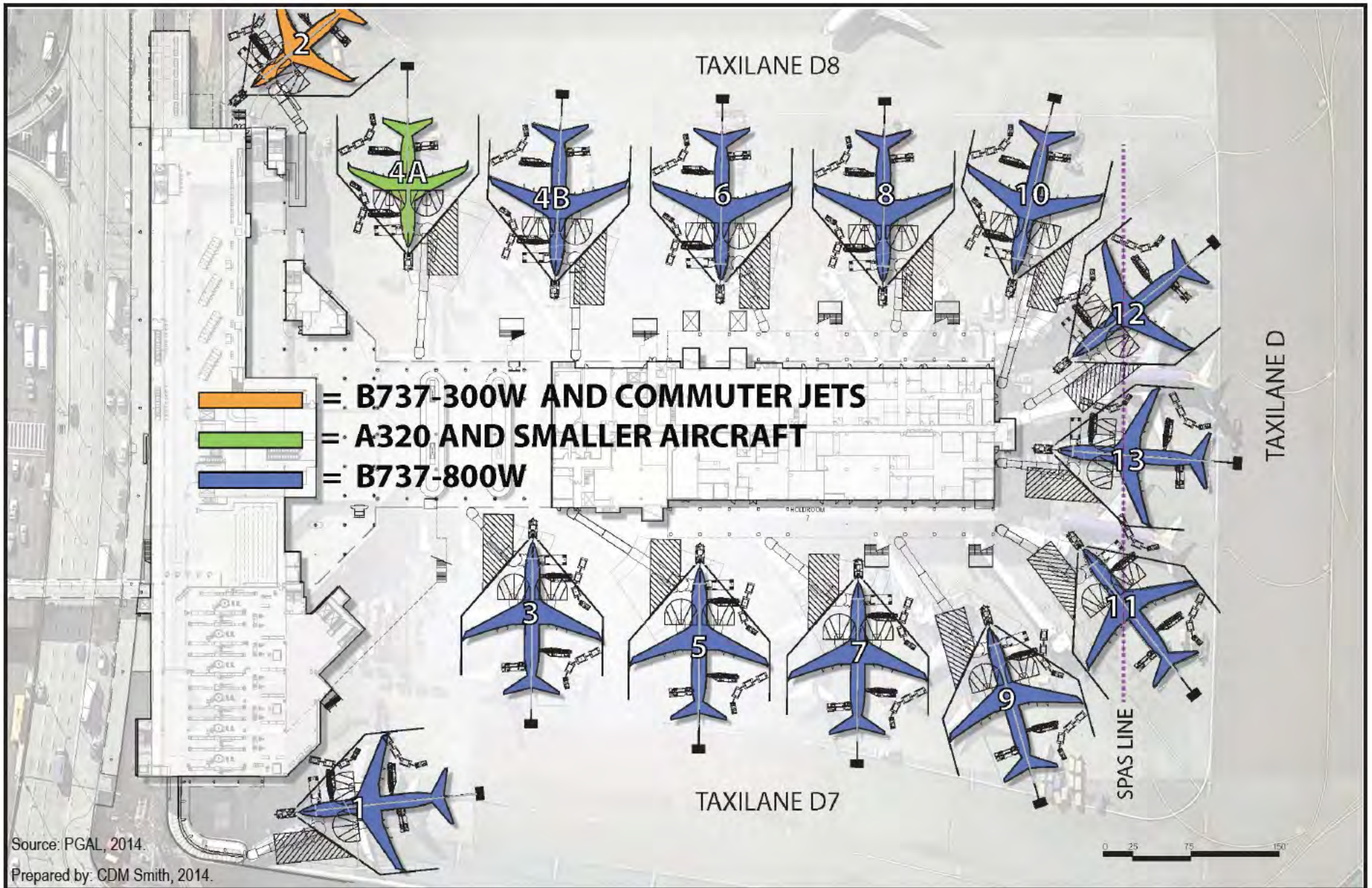

LAX Terminal 1 Modernization Project

Proposed Gate Configuration

Figure
9

This page intentionally left blank.

Departure Level

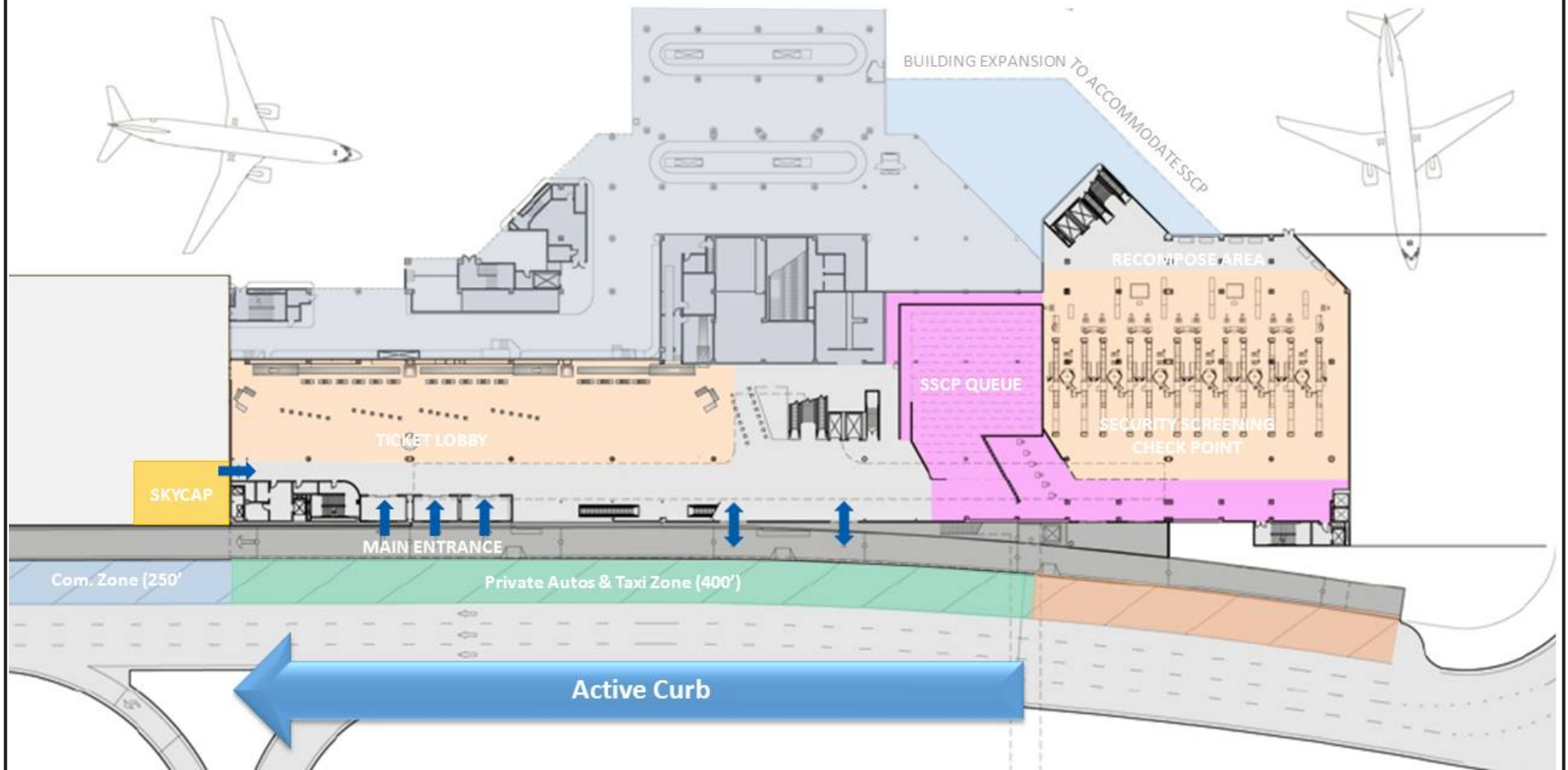

LAX Terminal 1 Modernization Project

Proposed Curbside - Departures Level

Figure
10

This page intentionally left blank.

On the arrivals level, as previously described, new baggage claim devices would be installed within the western portion of the building, and the existing baggage claim area within the eastern portion of the building would be replaced with the new CBIS system and other uses. Similar to the departures level, this would shift passenger activity to the west with a similar effect on the arrivals level curb, creating an active curb in front of the western half of the building and a deactivated curb in front of the eastern half of the building.

Construction

Development of the proposed improvements would occur on portions of LAX that are currently paved or developed with buildings. The proposed project includes the expanding portions of the Terminal 1 building. In addition, many of the proposed improvements are modified interior spaces and façade upgrades. Construction activities associated with the proposed project include demolition, site preparation, foundation work, and building construction.

The proposed project would take approximately 42 months to construct. Construction would commence during Fall 2014 and is projected to end in Winter 2017. Terminal 1 currently has 15 gates. During construction, it is expected that no more than 12 gates would remain operational and in service to support SWA's flight schedule, which would remain largely unchanged throughout the duration of construction. SWA has determined that this number of gates is adequate to support planned flight operations through 2017.

On average, approximately 185 construction personnel would be onsite at any one time. Work would occur during two shifts per day. Shift 1 would run from 10:00 pm to 6:30 am and Shift 2 would begin at 6:00 am and end at 2:30 pm. At the peak of construction activities, approximately 329 workers would be onsite.

The primary consideration in planning for the construction activities is to maintain safe and uninterrupted operation of the airport, including runway operations and passenger access to terminals. The majority of the construction activities would occur during daytime hours behind construction barriers. Construction would occur in phases, with only sections of the terminal shut down at one time. Shift 1 would be used for those work activities that cannot be accomplished on the daytime shift due to coordination and interference issues (e.g., airport operations, safety, delivery of materials).

The proposed project would be constructed in three major stages as listed below:

1. Ticketing Building West
2. Ticketing Building East
3. Concourse & Gate Systems

Each stage may be broken into phases. For example, to maintain a minimum of 12 gates in operation, construction of the concourse and gate systems may be constructed in as many as nine phases.

Site disturbance would be limited to the replacement of the aircraft parking ramp pavement, which would be phased over the course of the construction period. The total area of pavement to be replaced is approximately 460,000 SF or 10.6 acres. Currently, nine phases are planned, which would result in an area of approximately 50,000 SF being disturbed at a time, although some phases may result in a greater area of disturbance. Work on one ramp pavement phase would be completed prior to beginning work on the next phase.

During the course of construction, a total of approximately 23,570 deliveries and haul trips are anticipated or one delivery per hour, including approximately 7,700 truck trips total associated with

the concrete replacement and site grading, 310 trips for removal of trash and debris, 15,560 trips for the delivery of new materials, fixtures, furnishings, and equipment.

The export of soil or demolition debris offsite would require submittal of a Haul Route Form and Haul Route Map to the City of Los Angeles, Department of Building and Safety in order for the Department to develop a Haul Route Plan. In addition, pursuant to standard City of Los Angeles, Department of Transportation (LADOT) practices, a Work Traffic Control Plan, showing the location of construction areas and identifying construction traffic, would be required to be submitted to LADOT. The plan would include measures to avoid significant conflicts between project-related construction traffic and traffic in local (off-airport) roadways.

A Construction Coordination Plan would also be prepared for the proposed project that includes, but would not be limited to, the following:

- Phasing of activities to ensure that a minimum of 12 gates would be available at any one time
- Phasing of some activities overnight when passenger activity is low
- Separating passengers from construction activities with solid construction walls
- Prohibiting construction activity that would be disruptive to aircraft movement
- Ensuring that no foreign object debris would be deposited on the aircraft apron

These, and other provisions detailed in the Construction Coordination Plan, would ensure that the terminal would be fully operational at all times and that conflicts with terminal and airfield activities during construction would be avoided.

Construction staging would be located on developed areas of the airport, some of which are already in use for construction staging and laydown activities. Secure Area Access Post (SAAP) No. 3 is the preferred entry point for construction materials as it is the closest SAAP in proximity to Terminal 1 and potential staging areas. Other potential access options include, but are not limited to SAAP No.4, SAAP No.21, and SAAP No.23. Figure 11 shows several alternative locations that may be used for construction staging. Each location is a previously disturbed area within LAX; many of the potential construction staging areas have been used for similar construction staging activities in the past. The construction staging locations and entry points would be coordinated with construction staging activities associated with other projects taking place concurrently at LAX. The locations of construction staging areas location may vary throughout the construction period.

7.0 NECESSARY APPROVALS

Approvals required for the proposed project include, but may not be limited to, the following:

- Project approval by LAWA
- Project approval by the Board of Airport Commissioners and adoption of the Negative Declaration
- U.S. Department of Transportation Federal Aviation Administration (FAA) approval of Form 7460 (Notice of Proposed Construction or Alteration) in consideration of Part 77 requirements
- Grading, foundation, and building permits, and a Haul Route Plan from the City of Los Angeles Department of Building and Safety
- Work Traffic Control Plan by the City of Los Angeles Department of Transportation
- Cultural Affairs Commission design approval and public art requirements
- Any additional actions as may be determined necessary



Source: Hensel Phelps, 2014.
 Prepared by: CDM Smith, 2014.

LAX Terminal 1 Modernization Project

Construction Staging Area Map

Figure
11

This page intentionally left blank.

ATTACHMENT B
EXPLANATION OF CHECKLIST DETERMINATION

I. AESTHETICS. *Would the project:*

a. Have a substantial adverse effect on a scenic vista?

Less Than Significant Impact. The project site is located within the eastern portion of the LAX Central Terminal Area (CTA) and is not a prominent feature in any scenic vistas. Broad scenic vistas of the Santa Monica Mountains in the distance beyond LAX are available from some north-facing residences at higher elevations in the El Segundo residential neighborhood located approximately 1 mile to the south. Terminal 1 does not contribute to, or detract from, scenic vistas from these residences due to its location beyond the intervening cargo and landside uses, the south airfield, and the south terminals as well as the higher vantage points from the residences (Terminal 1 is well below their line-of-sight). Moreover, the proposed project would not increase the height of the terminal and would not alter existing long-range views of the Santa Monica Mountains. As such, the implementation of the proposed project would not have a substantial adverse effect on views of the Santa Monica Mountains (i.e., a scenic vista). The proposed project would also be visible from the upper floors of the hotels along Century Boulevard. However, the proposed project would be visually consistent with adjacent airport-related uses and would not disrupt views of the airfield. Therefore, impacts related to scenic vistas would be less than significant with the implementation of the proposed project and no mitigation is required.

b. Substantially damage scenic resources, including, but not limited to, trees, rock outcroppings, and historic buildings, or other locally recognized desirable aesthetic natural feature within a state or city-designated scenic highway?

Less Than Significant Impact. The project site is currently occupied by a terminal building and related aircraft gates and apron. The site is visible from Sepulveda Boulevard and Century Boulevard to the east and is visible in the distance from Interstate 105. The project site is not located adjacent to or within the viewshed of a designated scenic highway. The nearest officially designated state scenic highway is approximately 22 miles northwest of the proposed project site (State Highway 2, from approximately 3 miles north of Interstate 201 in La Cañada to the San Bernardino County Line). The nearest eligible state scenic highway (which is not officially designated by the state, but is a City-designated scenic highway) is State Highway 1, which has a starting point at Lincoln and Venice Boulevards, approximately 4.3 miles from the project site, and proceeds northwesterly to Point Mugu.⁴ Vista del Mar, the nearest City-designated scenic highway, is located approximately 2.3 miles west of the project site; the project site is not visible from Vista del Mar. There are no direct views to or from any scenic highways.

The Los Angeles/El Segundo Dunes are located approximately 2 miles west of the project site, opposite Pershing Drive. The project site is not visible from the dunes and the proposed project would not obstruct any views of dunes. The proposed project is not located within the viewshed of any other scenic resources or other locally recognized desirable aesthetic natural feature. In addition, the project

⁴ California Department of Transportation, [California Scenic Highway Mapping System website](http://www.dot.ca.gov/hq/LandArch/scenic_highways/index.htm). Available: http://www.dot.ca.gov/hq/LandArch/scenic_highways/index.htm, accessed August 14, 2013.

site does not contain any trees, rock outcroppings, or other locally recognized desirable aesthetic natural features within a City-designated scenic highway. Therefore, impacts related to scenic resources, including scenic highways, would be less than significant with the implementation of the proposed project and no mitigation is required.

The potential for implementation of the proposed project to substantially damage historic resources is detailed below under Response V.a.

c. Substantially degrade the existing visual character or quality of the site and its surroundings?

Less Than Significant Impact. The project site is a highly disturbed area within a busy international airport. The proposed project site is occupied by the existing Terminal 1 building, including curbside functions, ticketing, passenger processing, baggage processing and claims area, passenger serving uses and holding areas, gates, and aircraft apron areas. Terminal 1 and the majority of the surrounding structures are of a utilitarian style of architecture. However, several structures with notable architecture, including the Theme Building and former airport traffic control tower, are located within the project area. Views of the CTA and the existing airfield, while of public interest, are not scenic or of high quality visual character.

Implementation of the proposed project would modernize and improve the aesthetic quality of Terminal 1 and the visual character of this important entrance to the CTA. The project would include a number of improvements to the southern building exterior, which is the portion of the building that faces World Way and the CTA. A canopy similar in look, materials, and functionality to the new canopy at the Tom Bradley International Terminal (TBIT) would be constructed as a part of the proposed project. Street lights along the upper level roadway would be replaced by the same lights recently added to the roadway in front of TBIT. Also, the existing storefront and glazing would be replaced, and the existing precast concrete panels cleaned and panel joints repaired. The horizontal sloped windows and metal panels would be removed and replaced with a perforated metal screen which would disguise the rounded top of the building and improve the overall appearance of the terminal. The elevation of the terminal would not change, therefore views of Terminal 1 would not be affected. Further, construction activities at the proposed project site would be visually consistent with the current use of the site and surroundings. Therefore, impacts on the existing visual character or quality of the site and its surroundings would be less than significant with the implementation of the proposed project, and no mitigation is required.

d. Create a new source of substantial light or glare which would adversely affect day or nighttime views in the area?

Less Than Significant Impact. The project site is in an urban area with many existing sources of ambient lighting, including building lighting, roadway lighting (within the CTA), and airport operations lighting, such as lights from aircraft and airside equipment, apron/terminal lights, and airfield lights (runway and taxiway lights). Building and roadway lighting associated with the proposed project would be consistent with the type of lighting found in the CTA and would be in compliance with applicable FAA standards and in conformance with relevant LAWA light and glare guidelines. The proposed design concept would incorporate expanded storefront glazing along the curb, as well as glazed walls in the concourse to provide vistas of the airfield and surrounding landscape. The storefront glazing would be shielded by a canopy that would prevent glare. The glazed walls in the concourse would replace existing glass and would not represent a new source of

glare. External lights would be shielded and focused to avoid glare and prevent unnecessary light spillover. Therefore, implementation of the proposed project would not create a new source of substantial light or glare which would adversely affect day or nighttime views in the area. Impacts related to light and glare would be less than significant and no mitigation is required.

II. AGRICULTURAL AND FORESTRY RESOURCES. *In determining whether impacts to agricultural resources are significant environmental effects, lead agencies may refer to the California agricultural land evaluation and site assessment model (1997) prepared by the California Department of Conservation as an optional model to use in assessing impacts on agriculture and farmland. Would the project:*

- a. Convert Prime Farmland, Unique Farmland, or Farmland of Statewide Importance, as shown on the maps prepared pursuant to the Farmland Mapping and Monitoring Program of the California Resources Agency, to non-agricultural use?**
- b. Conflict with the existing zoning for agricultural use, or a Williamson Act Contract?**
- c. Conflict with existing zoning for, or cause rezoning of, forest land (as defined in Public Resources Code Section 12220(g)), timberland (as defined by Public Resources Code Section 4526), or timberland zoned Timberland Production (as defined by Government Code Section 51104(g))?**
- d. Result in the loss of forest land or conversion of forest land to non-forest use?**
- e. Involve other changes in the existing environment which, due to their location or nature, could result in conversion of Farmland, to non-agricultural use or conversion of forest land to non-forest use?**

a-e. No Impact. The project site is located within a developed airport and is surrounded by airport uses and urbanized areas. There are no agricultural or forest resources or operations at the project site or surrounding areas, including prime or unique farmlands or farmlands of statewide local importance. Further, there are no Williamson Act contracts in effect for the project site or surrounding areas.⁵ The proposed project would represent a continuation of the current airport-related uses and would not convert farmland to non-agricultural use nor would it result in any conflicts with existing zoning for agricultural use or a Williamson Act contract.

There are no forest land or timberland resources or operations within the vicinity of the project site, including timberland zoned Timberland Production. The proposed project would be consistent with the current airport-related and urban uses and would not convert forest land or timberland to non-forest. Therefore, no impacts to agricultural or forest land or timberland resources would occur with implementation of the proposed project and no mitigation is required.

⁵ City of Los Angeles, Final Environmental Impact Report for Los Angeles International Airport (LAX) Proposed Master Plan Improvements, Section 4.16, April 2004.

III. AIR QUALITY. *The significance criteria established by the South Coast Air Quality Management District (SCAQMD) may be relied upon to make the following determinations. Would the project:*

a. Conflict with or obstruct implementation of the applicable South Coast Air Quality Management District plans?

Less Than Significant Impact. The proposed project is located in the South Coast Air Basin (SCAB), which is under the jurisdiction of the SCAQMD. The SCAQMD is the regional agency responsible for air quality regulations within the SCAB including enforcing the California Ambient Air Quality Standards (CAAQS) and implementing strategies to improve air quality and to mitigate effects from new growth. The SCAQMD, in association with the California Air Resources Board (CARB) and the Southern California Association of Governments (SCAG), is responsible for preparing the Air Quality Management Plan (AQMP) that details how the region intends to attain or maintain the state and federal ambient air quality standards.

The Final 2012 AQMP⁶ describes the SCAQMD's plan to attain the federal standard for fine particulate matter less than or equal to 2.5 microns (μm) in diameter (PM_{2.5}) by 2014 and to continue improving ozone (O₃) levels. Proposed control measures include reducing PM_{2.5} and nitrogen oxides (NO_x) emissions from on- and off-road vehicle engines. In 2007, CARB adopted a regulation to reduce diesel particulate matter and NO_x emissions from in-use (existing) off-road heavy-duty diesel vehicles. The Final 2012 AQMP proposes to carry forward control measures for ozone presented in the Final 2007 AQMP,⁷ which includes requiring the use of cleaner (as compared to "baseline") off-road equipment. Any construction equipment used for the proposed project would operate in compliance with the state law and would be consistent with the objectives of the Final 2007 AQMP. Furthermore, the proposed project would be designed to meet the requirements of the 2010 California Green Building Standards Code (CALGreen) Tier 1 and would incorporate energy efficiency and water conservation measures, as identified in Section 5.0, Project Description. The project would meet the goals of the AQMP related to energy efficiency and conservation and, therefore, would not conflict with the AQMP.

The City of Los Angeles adopted an Air Quality Element that is part of the General Plan.⁸ Objective 1.3 of the Air Quality Element is to reduce particulate matter emissions from unpaved areas, parking lots, and construction sites. All activities would be compliant with the SCAQMD's Rule 403 for fugitive dust control, thereby resulting in particulate matter emission reductions. Objective 5.1 of the Air Quality Element is to reduce energy consumption and shift to non-polluting sources of energy in buildings and operations. The proposed project would be designed and constructed in accordance with CALGreen standards, thereby meeting the requirements of the General Plan. The proposed project would not change the basic operation of the terminal. However, the project would be designed with features to reduce criteria pollutant emissions, including gates with 400 Hz power, pre-conditioned air, and potable water equipment, as well as new energy efficient battery chargers to support an all-electric ground support equipment (GSE) program. For these reasons, the proposed project would be consistent with the Air Quality Element of the General Plan.

⁶ South Coast Air Quality Management District, Final 2012 Air Quality Management Plan, December 2012.

⁷ South Coast Air Quality Management District, Final 2007 Air Quality Management Plan, June 2007.

⁸ City of Los Angeles, Department of City Planning, Air Quality Element: An Element of the General Plan of the City of Los Angeles, November 1992.

As discussed above, implementation of the proposed project would not obstruct or conflict with the applicable SCAQMD plan and thus, the impact is less than significant, and no mitigation is required.

b. Violate any air quality standard or contribute substantially to an existing or projected air quality violation?

Less Than Significant Impact. The California Clean Air Act, signed into law in 1988, established the CAAQS; all areas of the state are required to achieve and maintain the CAAQS by the earliest practicable date. Regions of the state that have not met one or more of the CAAQS are known as nonattainment areas, while regions that meet the CAAQS are known as attainment areas.

The project site is located in the Los Angeles County sub-area of the SCAB. Los Angeles County is designated as a state nonattainment area for O₃ (which is evaluated using as surrogates volatile organic compounds, or VOC, and NO_x), PM_{2.5}, inhalable particulate matter less than or equal to 10 µm in diameter (PM₁₀), nitrogen dioxide (NO₂), and lead; and an attainment or unclassified area for carbon monoxide (CO), sulfur dioxide (SO₂), sulfates, hydrogen sulfide, and visibility reducing particles.⁹

Significance Thresholds

The SCAQMD publishes thresholds of significance for criteria pollutants.¹⁰ If the proposed project were to result in substantial emissions that would exceed the significance criteria, then a significant impact would occur. Table 2 summarizes the mass daily thresholds for construction and operation.

Table 2		
SCAQMD Mass Daily Pollutant Emission CEQA Thresholds of Significance		
Pollutant	Construction	Operation
NO _x	100 lbs/day	55 lbs/day
VOC	75 lbs/day	55 lbs/day
PM ₁₀	150 lbs/day	150 lbs/day
PM _{2.5}	55 lbs/day	55 lbs/day
SO _x	150 lbs/day	150 lbs/day
CO	550 lbs/day	550 lbs/day
Lead	3 lbs/day	3 lbs/day

Source: SCAQMD 2011.

⁹ California Air Resources Board, Area Designations Maps/State and National Homepage, Available: <http://www.arb.ca.gov/desig/adm/adm.htm>, accessed December 30, 2013.

¹⁰ South Coast Air Quality Management District, SCAQMD Air Quality Significance Thresholds, March 2011.

Methodology

Emissions from construction equipment, haul trucks, and construction worker commuting trips, fugitive VOCs from architectural coatings, and fugitive dust from soil handling, grading, and paved road dust were calculated. The CARB on-road motor vehicle emission factor model (EMFAC2011), CARB off-road motor vehicle emission factor model (OFFROAD2007), CARB In-Use Off-Road Equipment 2011 Inventory Model, and assumptions built into the California Emissions Estimator Model (CalEEMod), Version 2013.2.2, were used to estimate criteria and precursor pollutant emissions (VOCs, NO_x, CO, SO₂, PM10, and PM2.5).^{11,12,13} The analysis does not estimate lead emissions because no major sources of lead would occur at the site.

CalEEMod is a statewide land use emissions computer model that estimates construction and operational emissions from a variety of land use projects. However, the model does not have default data on terminal construction projects. Because project-specific schedule, equipment types, hours of equipment operation, number of construction workers, material import and export amount, and number of haul trips were available, only the equations and assumptions contained within CalEEMod were used. Fugitive dust equations used in CalEEMod are based on U.S. Environmental Protection Agency's Compilation of Air Pollutant Emission Factors, or AP-42.¹⁴ Operations (i.e., number of passengers or aircraft operations) are expected to not change as a result of the proposed project; therefore, operational emissions were not calculated. Refer to Appendix A of this IS/ND for the detailed model results.

Project control features, presented below, were identified and incorporated into the modeling.

Project Control Measures

Although project operations would not result in significant impacts to air quality, design features associated with the proposed project would reduce operational emissions, including the provision of new electric GSE chargers and infrastructure that could accommodate an all-electric GSE program at Terminal 1, and electric power and pre-conditioned air at all gates.

The following project control measures would address construction-related emissions associated with the proposed project. These measures were selected from a list of standard control measures developed by LAWA for projects at LAX. Only those measures that are applicable to the proposed project are identified below. Measure numbers follow those on the standard list, therefore, the numbers listed in the tables below may not be consecutive.

¹¹ California Air Resources Board, EMFAC Emissions Database, Available: <http://www.arb.ca.gov/emfac/>, accessed December 27, 2013.

¹² California Air Resources Board, Off-Road Motor Vehicles Homepage, Available: http://www.arb.ca.gov/msei/categories.htm#offroad_motor_vehicles, accessed December 27, 2013.

¹³ California Air Pollution Control Officers Association, California Emissions Estimator Model (CalEEMod) Homepage, Available: <http://www.caleemod.com/>, accessed December 27, 2013.

¹⁴ United States Environmental Protection Agency. Compilation of Air Pollutant Emission Factors (AP-42). Fifth Edition, Volume I. Available: <http://www.epa.gov/ttnchie1/ap42/>, accessed December 27, 2013.

◆ **AQ-1 – General Air Quality Control Measures.**

This measure describes a variety of specific actions to reduce air quality impacts associated with project construction. Some components of AQ-1 are not readily quantifiable, but would be implemented as part of the proposed project. Specific measures are identified in Table 3.

Table 3			
General Air Quality Control Measures			
Measure Number	Measure	Type of Measure	Quantified Emissions Reduction
1a	Watering twice daily (per SCAQMD Rule 403 and CalEEMod default).	Fugitive Dust	55% PM10 and PM2.5
1b	Ultra-low sulfur diesel (ULSD) fuel will be used in construction equipment.	Off-Road Mobile	Assumed in modeling
1c	Post a publicly visible sign with the telephone number and person to contact regarding dust complaints; this person shall respond and take corrective action within 24 hours.	Fugitive Dust	NQ
1d	Prior to final occupancy, the applicant demonstrates that all ground surfaces are covered or treated sufficiently to minimize fugitive dust emissions.	Fugitive Dust	NQ
1f	Prohibit idling or queuing of diesel-fueled vehicles and equipment in excess of five minutes. This requirement will be included in specifications for any LAX projects requiring on-site construction.	Nonroad Mobile	NQ
1g	Require that all construction equipment working on-site is properly maintained (including engine tuning) at all times in accordance with manufacturers' specifications and schedules.	Mobile and Stationary	NQ
NQ = Not Quantified.			

◆ **AQ-2 - Construction-Related Control Measures.**

This measure describes numerous specific actions to reduce fugitive dust emissions and exhaust emissions from on-road and off-road mobile and stationary sources used in construction. Some components of AQ-2 are not readily quantifiable, but would be implemented as part of the proposed project. These control strategies are expected to reduce construction-related emissions. Specific measures are identified in Table 4.

Table 4 Construction-Related Air Quality Control Measures			
Measure Number	Measure	Type of Measure	Potential Emissions Reduction
2d	To the extent feasible, have construction employees' work/commute during off-peak hours.	On-Road Mobile	NQ
2e	Make available on-site lunch trucks during construction to minimize off-site worker vehicle trips.	On-Road Mobile	NQ
2g	Specify combination of electricity from power poles and portable diesel- or gasoline-fueled generators using "clean burning diesel" fuel and exhaust emission controls, as feasible.	Stationary Point Source Controls	NQ
2h	Suspend use of all construction equipment during a second-stage smog alert in the immediate vicinity of LAX.	Mobile and Stationary	NQ
2i	Utilize construction equipment having the minimum practical engine size (i.e., lowest appropriate horsepower rating for intended job).	Mobile and Stationary	NQ
2j	Prohibit tampering with construction equipment to increase horsepower or to defeat emission control devices.	Mobile and Stationary	NQ
2k	The contractor or builder shall designate a person or persons to ensure the implementation of all components of the construction-related measure through direct inspections, record reviews, and investigations of complaints.	Administrative	NQ
2m	LAWA will ensure that there is available and sufficient infrastructure on-site, where not operationally or technically infeasible, to provide fuel to alternative-fueled vehicles to meet all requests for alternative fuels from contractors and other users of LAX. This will apply to construction equipment and to operations-related vehicles on-site. This provision will apply in conjunction with construction or modification of passenger gates relative to the provision of appropriate infrastructure for electric GSE.	Mobile	NQ
2n	A minimum of 50% of on-road trucks used during construction of the proposed project with a gross vehicle weight rating of at least 19,500 pounds shall, at a minimum, comply with USEPA 2007 on-road emissions standards for PM10 and NO _x , as feasible.	On-Road Mobile	Assumed in modeling
NQ = Not Quantified			

Estimated Project Emissions

Table 5 summarizes maximum daily emissions that would occur from project-related construction activities with implementation of project control measures.

Table 5						
Construction Emissions Summary – Criteria Pollutants						
	Maximum Daily Emissions (pounds per day)					
	VOC	NO_x	CO	SO₂	PM10	PM2.5
Maximum Emissions	37	91	114	<1	11	6
SCAQMD Construction Threshold	75	100	550	150	150	55
Significant Impact?	No	No	No	No	No	No

Source: CDM Smith 2014.

With inclusion of project control measures, construction emissions would not violate an air quality standard or contribute substantially to an existing or projected air quality standard. Therefore, the impact is less than significant.

c. Result in a cumulatively considerable net increase of any criteria pollutant for which the air basin is non-attainment (O₃, NO₂, PM10, PM2.5, and lead) under an applicable federal or state ambient air quality (including releasing emissions which exceed quantitative thresholds for ozone precursors)?

Less Than Significant Impact. Cumulative impacts occur when the impact of one project when added to other past, present, or reasonably foreseeable probable future projects could cause a significant impact. In other words, although an individual project may be less than significant, the combined impacts from the proposed project in conjunction with other projects could cause a significant impact. According to the SCAQMD¹⁵, projects that do not exceed the significance thresholds are generally not considered to be cumulatively significant. As shown in Table 5, emissions of the all criteria pollutants from construction activities, including the nonattainment pollutants (PM10, PM2.5, and O₃ precursors [NO_x and VOC]), would be less than the SCAQMD significance thresholds with inclusion of project control features. Therefore, the contribution of the proposed project to cumulative emissions of these pollutants would not be cumulatively considerable.

The proposed project would not affect operations at Terminal 1; therefore, there are no cumulative impacts from project operation.

d. Expose sensitive receptors to substantial pollutant concentrations?

Less Than Significant Impact. As described in Response III.b above, daily construction emissions with mitigation would be below significance thresholds. Diesel particulate matter is listed as a toxic air contaminant in California and would be subject to human health risk standards of 10 in 1 million for the maximum individual cancer risk and 1.0 (project increment) for the chronic and acute hazard indices. The closest sensitive receptors (i.e., hospitals, K-12 schools, residences, and day care

¹⁵ South Coast Air Quality Management District, White Paper on Potential Control Strategies to Address Cumulative Impacts from Air Pollution, August 2003.

centers) are the residential areas within the neighborhood of Westchester to the north and hotels located along Century Boulevard.

The SCAQMD developed thresholds for local air quality impacts from construction activities.¹⁶ Localized significance thresholds (LSTs) are only applicable to the following criteria pollutants: NO_x, CO, PM10, and PM2.5. LSTs are analogous to National Ambient Air Quality Standards (NAAQS) and CAAQS; pollutant levels below LSTs would not necessarily be expected to violate the NAAQS or CAAQS. LSTs consider ambient concentrations of pollutants for each source receptor area and distances to the nearest sensitive receptor.

As indicated in Section 5.0, Project Description, based on the proposed construction phasing schedule, only 1.2 acres of area would be disturbed at a time. For purposes of the LST analysis, allowable emissions were assumed to occur for a 2-acre project area, in order to provide a conservative analysis. Table 6 summarizes the onsite emissions, which include fugitive dust and off-road construction equipment, and allowable emissions for a 2-acre project located in the Southwest Coastal Los Angeles County Source-Receptor Area. LSTs consider ambient concentrations of pollutants for each source receptor area and distances to the nearest sensitive receptor. The closest receptor (i.e., Radisson Hotel on Century Boulevard) from the project site boundary is located at a distance of approximately 360 meters (1,180 feet); therefore, the LST thresholds were scaled from the 200 meter (656 feet) and 500 meter (1,641 feet) thresholds.

Table 6						
Onsite Emissions Summary – Criteria Pollutants						
	Maximum Onsite Daily Emissions (pounds per day)					
	VOC	NO_x	CO	SO₂	PM10	PM2.5
Maximum Emissions	36	59	57	<1	6	4
Construction LST	N/A	201	5,533	N/A	109	55
Significant Impact?	N/A	No	No	N/A	No	No

Source: CDM Smith 2014.

Anticipated maximum daily onsite emissions would be below the applicable LSTs. Therefore, implementation of the proposed project would not expose sensitive receptors to substantial pollutant concentrations. The impact would be less than significant, and no mitigation is required.

e. Create objectionable odors affecting a substantial number of people?

Less Than Significant Impact. The use of diesel equipment during construction may generate near-field odors that are considered to be a nuisance. Diesel equipment emits a distinctive odor that may be considered offensive to certain individuals. Due to the temporary nature of these activities and distance to sensitive receptors, odors from diesel exhaust would not affect a substantial number of people. Moreover, diesel equipment odors would be minimized through implementation of construction-related control measures, such as measures 2g, 2i, and 2n. Implementation of these measures would ensure that odors associated with construction-related diesel equipment would be limited. –Operation of the proposed project would not create objectionable odors. Therefore,

¹⁶ South Coast Air Quality Management District, Final Localized Significance Threshold Methodology, July 2008.

implementation of the proposed project would not create objectionable odors affecting a substantial number of people. The impact is less than significant, and no mitigation is required.

IV. BIOLOGICAL RESOURCES. *Would the project:*

- a. Have a substantial adverse effect, either directly or through habitat modification, on any species identified as a candidate, sensitive, or special status species in local or regional plans, policies, or regulations by the California Department of Fish and Wildlife or U.S. Fish and Wildlife Service?**
- b. Have a substantial adverse effect on any riparian habitat or other sensitive natural community identified in the City or regional plans, policies, or regulations or by the California Department of Fish and Wildlife or U.S. Fish and Wildlife Service?**
- c. Have a substantial adverse effect on federally protected wetlands as defined by Section 404 of the Clean Water Act (including, but not limited to, marsh, vernal pool, coastal, etc.) through direct removal, filling, hydrological interruption, or other means?**
- d. Interfere substantially with the movement of any native resident or migratory fish or wildlife species or with established native resident or migratory wildlife corridors, or impede the use of native wildlife nursery sites?**
- e. Conflict with any local policies or ordinances protecting biological resources, such as tree preservation policy or ordinance (e.g., oak trees or California walnut woodlands)?**
- f. Conflict with the provisions of an adopted Habitat Conservation Plan, Natural Community Conservation Plan, or other approved local, regional, or state habitat conservation plan?**

a-f. No Impact. The project site is located in a highly developed area within the CTA. Moreover, the areas planned to be used for construction staging (illustrated in Figure 11), are located on developed areas of the airport, some of which are already in use for construction staging and laydown activities. Both Terminal 1 and the planned construction staging areas are devoid of biological resources. However, other areas within the airport boundary contain plant and animal species as well as habitats identified as sensitive. None of the identified sensitive plant or animal species have been identified on the project site or the construction staging areas, or in their immediate vicinity. Therefore, no impacts to sensitive or special status species or habitats are expected to occur.

There are no riparian/wetland areas, trees, or wildlife movement corridors at or adjacent to the project site or construction staging areas. Therefore, no impacts to any riparian or other sensitive natural community would occur. There is no adopted Habitat Conservation Plan, Natural Community Conservation Plan, or other approved local, regional, or state habitat conservation plan that includes the project site or construction staging areas. The Dunes Specific Plan Area (i.e., Los Angeles/El Segundo Dunes), a designated Los Angeles County Significant Ecological Area, is located in the western portion of LAX, approximately 2 miles west of the project site. The Dunes area is well removed from the project site and would not be affected by the proposed project. Therefore, no impacts to biological resources would occur with implementation of the proposed project and no mitigation is required.

V. CULTURAL RESOURCES. *Would the project:*

a. Cause a substantial adverse change in significance of a historical resource as defined in State CEQA §15064.5?

No Impact. LAX began as Mines Field in 1928, when the City of Los Angeles leased 640 acres of the Bennett Rancho. The first permanent building at the airfield was constructed in 1929 by the Curtiss-Wright Flying School. Known as Hangar One, the building was designed by Los Angeles architects Gable and Wyant in a distinctive Spanish Colonial Revival style. Additional construction followed, until there were five hangars, a 2,000-foot paved runway, and administrative offices for the then Department of Aviation. Plans for a new modern airport were derailed by World War II. Wartime production activity at the aircraft manufacturing plants on and around the airport intensified dramatically. In 1942, the federal government assumed control of the airport and the Army Air Corps stationed planes and personnel at the field. After the war, a master plan envisioning two stages of development, an initial stage to immediately accommodate commercial operations and a long-range expansion of the field, was implemented. The Intermediate Facilities, consisting of four passenger terminals, new administrative buildings, and hangars for individual airlines, were opened on the north side of the airfield in 1946.

A boom in commercial air travel followed, accompanied by marked increases in air freight traffic. A new master plan for the Los Angeles International Airport, so named in 1949, began to be developed. In 1956, a new master plan for a "jet-age" airport was developed by an architectural joint venture of several prominent Los Angeles architects. Their innovative scheme incorporated a U-shaped access road flanked by six ticketing buildings that, in turn, were connected via subterranean passageways to remote satellite buildings containing the actual boarding gates. Passenger amenities were located in the individual satellites. The center of the "U" contained parking, an administrative building surmounted by a state-of-the-art control tower at the extreme east end of the site, an eye-catching Theme Building restaurant in the center of the site, and support facilities including a cooling tower, utility plant, and a service building located west of the Theme Building. Inspired by the aesthetics of the Jet Age, the Theme Building quickly became an internationally recognized symbol and centerpiece of the new airport, distinguished by its parabolic arches from which a flying saucer-shaped restaurant was suspended.

Continuing growth of both commercial and freight traffic at the airport has resulted in numerous improvements over the last few decades. These have included the development of two cargo centers, Cargo City (late 1960s) and the Imperial Cargo Complex (1980s); the Tom Bradley International Terminal (1984); and a new Airport Traffic Control Tower (1996). The earlier control tower, while considered state-of-the-art in 1961, was considerably altered in 1996 when the FAA relocated to the new airport traffic control tower.

Previously-identified historical resources at LAX include the following:¹⁷

- Hangar One (listed on National Register) on the southeastern portion of LAX near the northwest corner of Aviation Boulevard and Imperial Highway, approximately 0.9 mile east of the project site;
- Theme Building (eligible for National Register) in the center of the CTA;

¹⁷ City of Los Angeles, Draft Environmental Impact Report for Los Angeles International Airport (LAX) Specific Plan Amendment Study, Section 4.5, July 2012.

-
- WWII Munitions Storage Bunker (eligible for National Register) near the western boundary of LAX; and
 - Intermediate Terminal Complex (eligible for the California Register) on the south side of Century Boulevard between Sepulveda Boulevard and Airport Boulevard.

The existing Terminal 1 was constructed in 1986 and is not a designated historic resource. In 2011, as part of the preparation of the Draft EIR for the LAX Specific Plan Amendment Study, additional baseline data for cultural resources were collected. The data found no other structures within LAX than those noted above that were determined to be potentially historic.¹⁸

The nearest identified historical resource at LAX to the proposed Terminal 1 improvements is the Theme Building and Setting. The Theme Building is situated at the center of the CTA and southwest of Terminal 1. It has been determined eligible for listing in the National Register under Criteria Consideration G and Criterion C for its unique architecture, which has become symbolic not only of the airport but of the City of Los Angeles as a whole. In California, a property that has been determined eligible for listing in the National Register is automatically listed in the California Register. The Theme Building was also designated Los Angeles Historic Cultural Monument #570 in 1992. The 2011 historical resources survey results determined that, in addition to the Theme Building being historic, its “setting” is also eligible for listing. The “setting” includes the original exterior and interior fabric of the Theme Building as well as its immediate surrounds and the related airport setting and views, and collectively described as the "Theme Building and Setting."

Construction and operation of the LAX Terminal 1 Modernization Project would not affect the Theme Building and its setting. The exterior improvements associated with the proposed project would not alter the height of the building, therefore views of the Theme Building from the CTA or surrounding roads would not be affected. The widening of the concourse would be visually consistent with the existing structure and would not impede views of the airfield from the Theme Building.

One of the alternate construction staging and parking areas for the proposed project is Parking Structure F, which is located on the southeast corner of Century Boulevard and Avion Drive. This parking structure is located adjacent to the designated Intermediate Terminal Complex. This complex was determined ineligible for listing in the National Register by the FAA due to alterations and loss of some structures. Intended to be temporary in nature, the Intermediate Terminal Complex originally included the two office buildings and double-arched hangar that are still extant, plus five additional buildings that were used as passenger terminals and hangars. Demolition of the passenger terminals and alterations to the double-arched hangar prevents the complex from meeting National Register requirements for integrity. However, previous surveys found that, as a representative milepost in the evolution of LAX, the complex may be historically significant under Los Angeles Historic Cultural Monument criteria and, thus, appears eligible for local designation. It also appears to meet Criterion 1 under the California Register (i.e., is associated with events that have made a significant contribution to the broad patterns of California's history and cultural heritage). Currently, UAL conducts maintenance and cargo operations in the area designated as the Intermediate Terminal Complex. Construction staging activities associated with the LAX Terminal 1 Modernization project would include construction worker parking and possible equipment and materials storage. The construction staging activities are consistent with the current activities that occur within this area and would not

¹⁸ City of Los Angeles, Draft Environmental Impact Report for Los Angeles International Airport (LAX) Specific Plan Amendment Study, Section 4.5, July 2012.

alter or affect the Intermediate Terminal Complex buildings or their setting. In addition, the construction staging area in this area would be temporary. Operation of the proposed project would not affect the Intermediate Terminal Complex area. Therefore a substantial adverse change in significance of the Intermediate Terminal Complex would not occur.

Construction and operation of the proposed project would not cause a substantial adverse change in significance of any of the historical resources identified above, including the Theme Building and its Setting and the Intermediate Terminal Complex. Therefore, no impacts to historical resources would occur with implementation of the proposed project, and no mitigation is required.

b. Cause a substantial adverse change in significance of an archaeological resource pursuant to State CEQA §15064.5?

No Impact. The project site is a highly disturbed area that has long been, and is currently being, used for airport and airport-related land uses. Any resources that may have existed on the site at one time are likely to have been displaced or damaged and, as a result, the overall sensitivity of the site with respect to buried resources is low. Excavation associated with project construction would be limited to shallow excavation associated with removal and replacement of existing pavement and building foundation work associated with the building expansion. These activities would occur in previously-disturbed soils and no archaeological resources are expected to be encountered during construction. Therefore, no impacts to archaeological resources would occur with implementation of the proposed project, and no mitigation is required.

c. Directly or indirectly destroy a unique paleontological resource or site or unique geologic feature?

No Impact. The LAX property lies in the northwestern portion of the Los Angeles Basin, a broad structural syncline with a basement of older igneous and metamorphic rocks overlain by thick younger marine and terrestrial deposits. The older deposits that underlie the LAX area are assigned to the Palos Verdes Sand formation, which is one of the better known Pleistocene age deposits in southern California. The results of the records search conducted as part of the LAX Master Plan EIR indicate that the Palos Verdes Sand formation is a formation with a high potential for yielding unique paleontological deposits. The Palos Verdes Sand formation covers half of the LAX area, beginning at Sepulveda Boulevard and extending easterly beyond the airport. The records search conducted for the LAX Master Plan Final Environmental Impact Report (EIR) identified the presence of two vertebrate fossil occurrences within the airport area, three more in the immediate vicinity of the airport, and one within approximately 2 miles of the airport. These fossils were found at depths ranging from 13 to 70 feet. The deposits within which these resources occur were found to underlie the entire LAX area and surrounding vicinity.¹⁹ Therefore, excavation and grading activities greater than 13 feet have the potential to expose and damage potentially important fossils. As discussed for archaeological resources above, the project site is developed and excavation would be limited to shallow areas of previously disturbed soils. As a result, no direct or indirect impacts to unique paleontological resources or sites or unique geologic features are anticipated to occur with implementation of the proposed project, and no mitigation is required.

¹⁹ City of Los Angeles, Final Environmental Impact Report for Los Angeles International Airport (LAX) Proposed Master Plan Improvements, Section 4.9.1, April 2004.

d. Disturb any human remains, including those interred outside of formal cemeteries?

No Impact. The proposed project includes excavation activities during renovation and modernization of Terminal 1. Currently, the project site is occupied by the existing Terminal 1 building. Based on previous surveys conducted at LAX and the results of the record searches completed in 1995, 1997, 2000,²⁰ and 2011,²¹ no traditional burial sites have been identified within the LAX boundaries or in the vicinity. However, if human remains are encountered, all grading and excavation activities in the vicinity would cease immediately and the appropriate LAWA authority would be notified. Therefore, no impacts to human remains would occur with implementation of the proposed project, and no mitigation is required.

VI. GEOLOGY AND SOILS. *Would the project:*

a. Expose people or structures to potential substantial adverse effects, including the risk of loss, injury, or death involving:

i. Rupture of a known earthquake fault, as delineated on the most recent Alquist-Priolo Earthquake Fault Zoning Map issued by the State Geologist for the area or based on other substantial evidence of a known fault? Refer to Division of Mines and Geology Special Publication 42.

ii. Strong seismic ground shaking?

Less Than Significant Impact. Fault rupture is the surface displacement that occurs along the surface of a fault during an earthquake. The project site is located within the seismically active southern California region; however, there is no evidence of faulting on the site, and it is not located within an Alquist-Priolo Special Study Zone.²² Geotechnical literature indicates that the Charnock Fault, a potentially active fault, may be located near or through the eastern portion of the project site. However, evaluation indicates that the Charnock Fault is considered to have low potential for surface rupture independently or in conjunction with movement on the Newport-Inglewood Fault Zone, which is located approximately 3 miles east of the project site.²³

Terminal 1 was built prior to the 1994 Northridge earthquake and was not designed to current building codes. The modernization project would provide the opportunity to make seismic improvements to the building, including strengthening the columns of the moment frame system, improving beam-to-column connections, and improvements to the foundation system if warranted. The design and construction of the proposed project would comply with current Los Angeles Building Code (LABC) and Uniform Building Code (UBC) requirements. These structural changes would improve the building's performance during a seismic event, thereby decreasing the risk of loss, injury, or death of building occupants associated with fault rupture or strong seismic ground shaking, and increasing the likelihood that occupants would be able to exit the building to a point of safety after an event.

²⁰ City of Los Angeles, Final Environmental Impact Report for Los Angeles International Airport (LAX) Proposed Master Plan Improvements, Section 4.9.1, April 2004.

²¹ City of Los Angeles, Draft Environmental Impact Report for Los Angeles International Airport (LAX) Specific Plan Amendment Study Project, Section 4.5, and Appendix E-1, July 2012.

²² City of Los Angeles, Final Environmental Impact Report for Los Angeles International Airport (LAX) Proposed Master Plan Improvements, Section 4.22, April 2004.

²³ City of Los Angeles, Final Environmental Impact Report for Los Angeles International Airport (LAX) Proposed Master Plan Improvements, Section 4.22, April 2004.

The main purpose of the proposed project is the modernization of Terminal 1. The proposed modernization would improve the quality of service provided to Terminal 1 passengers, and is not intended to increase passenger or aircraft use of the terminal. Therefore, implementation of the proposed project would not increase exposure of people or structures to risks associated with rupture of a known earthquake fault or strong seismic ground shaking. As such, impacts to people or structures to substantial adverse effects resulting from rupture of a known earthquake fault or strong seismic ground shaking would be less than significant, and no mitigation is required.

iii. Seismic-related ground failure, including liquefaction?

Less Than Significant Impact. Liquefaction is a seismic hazard that occurs when strong ground shaking causes saturated granular soil (such as sand) to liquefy and lose strength. The susceptibility of soil to liquefy tends to decrease as the density of the soil increases and the intensity of ground shaking decreases. Liquefaction potential is greatest where the groundwater levels are shallow and where submerged loose, fine sands occur within a depth of about 50 feet or less. The depth to groundwater at LAX is generally greater than 90 feet; the depth to groundwater at monitoring wells located east of Terminal 1 within Park One (formerly Allied Signal) ranges from 91 to 97 feet.²⁴ These groundwater depths indicate that the site has a very low susceptibility to liquefaction.²⁵ Perched groundwater has been noted at several locations and these areas could be subject to liquefaction; however, the overall potential for liquefaction at LAX is considered low.²⁶

Strong ground shaking will also tend to densify loose to medium dense deposits of partially saturated granular soils and could result in seismic settlement of foundations and the ground surface at LAX. Due to variations in material type, seismic settlements would tend to vary considerably across LAX, but are generally estimated to be between negligible and 0.5 inch; the overall potential for damaging seismically-induced settlement is considered to be low.²⁷

Seismically-induced ground shaking can also cause slope-related hazards through various processes including slope failure, lateral spreading,²⁸ flow liquefaction, and ground lurching.²⁹ Because the project site is flat, there is no potential for slope failures at the project site.

The California Department of Conservation (CDC) is mandated by the Seismic Hazards Act of 1990³⁰ to identify and map the state's most prominent earthquake hazards in order to help avoid damage resulting from earthquakes. The CDC's Seismic Hazard Zone Mapping Program charts areas

²⁴ California Water Resources Control Board, GeoTracker, Allied Signal (Park One) – L.A. (SL184101393), Geo Well 1st SA 2012 Data, Available:

http://geotracker.waterboards.ca.gov/profile_report.asp?cmd=viewgeo&sub_type=GEO_WELL&global_id=SL184101393&conf_num=7900756776, accessed January 28, 2014.

²⁵ City of Los Angeles, Final Environmental Impact Report for Los Angeles International Airport (LAX) Proposed Master Plan Improvements, Section 4.22, April 2004.

²⁶ City of Los Angeles, Final Environmental Impact Report for Los Angeles International Airport (LAX) Proposed Master Plan Improvements, Section 4.22, April 2004.

²⁷ City of Los Angeles, Final Environmental Impact Report for Los Angeles International Airport Proposed (LAX) Master Plan Improvements, Section 4.22, April 2004.

²⁸ Lateral Spreading: Deformation of very gently sloping ground (or virtually flat ground adjacent to an open body of water) that occurs when cyclic shear stresses caused by an earthquake induce liquefaction, reducing the shear strength of the soil and causing failure and "spreading" of the slope.

²⁹ Ground Lurching: Ground lurching (and related lateral extension) is the horizontal movement of soil, sediments, or fill located on relatively steep embankments or scarps as a result of earthquake-induced ground shaking. Damage includes lateral movement of the slope in the direction of the slope face, ground cracks, slope bulging, and other deformations.

³⁰ Public Resources Code 2690-2699.6.

prone to liquefaction and earthquake-induced landslides throughout California's principal urban and major growth areas. According to the Seismic Hazard Map for the Inglewood Quadrangle, no potential liquefaction zones are located within the LAX area. Isolated zones of potential seismic slope instability are identified within the dune area to the west of the proposed project site.³¹ Given the flat topography of the project site, it would not be subject to slope instability and the potential instability within the dune area to the west would not pose a risk to the project site.

In summary, the potential for seismic-related ground failure at the proposed project site is considered low. As part of the proposed project, all construction would be designed in accordance with the provisions of the UBC and the LABC. In addition, the proposed modernization would not increase passenger or aircraft use of the terminal and, therefore, would not result in the increased exposure of people or structures to substantial adverse risks associated with seismic-related ground failure. Therefore, potential impacts associated with seismic-related ground failure, including liquefaction, would be less than significant, and no mitigation is required.

iv. Landslides?

No Impact. The project site and vicinity are relatively flat and are primarily surrounded by existing airport and urban development. Furthermore, the City of Los Angeles Landslide Inventory and Hillside Areas map does not identify any areas in the vicinity of the project site that contain unstable slopes which may be prone to seismically-produced landslides.³² Implementation of the proposed project would not result in the exposure of people or structures to the risk of landslides during a seismic event. Therefore, no impacts resulting from landslides would occur with the implementation of the proposed project, and no mitigation is required.

b. Result in substantial soil erosion or the loss of topsoil?

Less Than Significant Impact. The potential for soil erosion on the project site is low due to the level topography of the project site and the fact that the site consists entirely of impervious surfaces. The proposed project would result in the demolition of existing pavement and use of fill during construction. Conformance with LABC Sections 91.7000 through 91.7016, which include construction requirements for grading, excavation, and use of fill, would reduce the potential for wind or waterborne erosion. In addition, the LABC requires an erosion control plan that is reviewed by the Department of Building and Safety prior to construction if grading exceeds 200 cubic yards and occurs during the rainy season (between November 1 and April 15). Therefore, proposed project impacts related to soil erosion would be less than significant, and no mitigation is required.

c. Be located on a geologic unit or soil that is unstable, or that would become unstable as a result of the project, and potentially result in on- or off-site landslide, lateral spreading, subsidence, liquefaction, or collapse?

Less Than Significant Impact. Settlement of foundation soils beneath engineered structures or fills typically results from the consolidation and/or compaction of the foundation soils in response to the increased load induced by the structure or fill. The presence of undocumented and typically weak

³¹ City of Los Angeles, Final Environmental Impact Report for Los Angeles International Airport (LAX) Proposed Master Plan Improvements, Section 4.22, April 2004.

³² City of Los Angeles, Department of City Planning, Safety Element of the City of Los Angeles General Plan, Exhibit C, Landslide Inventory & Hillside Areas in the City of Los Angeles, June 1994.

artificial fill at LAX creates the potential for settlement.³³ The Lakewood Formation also includes some silt and clay layers prone to settlement. However, foundation design features and construction methods can reduce the potential for excessive settlement at LAX, and the overall potential for damaging settlement is considered low.³⁴ Therefore, implementation of the proposed project is not anticipated to adversely affect a geologic unit or soil that is unstable, or that would become unstable as a result of the project, and potentially result in on- or off-site landslides, lateral spreading, subsidence, liquefaction, or collapse. The impact would be less than significant, and no mitigation is required. See also Responses VI.a.iii and VI.a.iv above.

d. Be located on expansive soil, as defined in Table 18-1-B of the Los Angeles Building Code (2002), creating substantial risks to life or property?

Less Than Significant Impact. Expansive soils are typically composed of certain types of silts and clays that have the capacity to shrink or swell in response to changes in soil moisture content. Shrinking or swelling of foundation soils can lead to damage to foundations and engineered structures including tilting and cracking. Fill materials located in some portions of the LAX area could be prone to expansion, and some portions of the Lakewood Formation found beneath the eastern portion of LAX may also be susceptible, due to their higher content of clay and silt.³⁵ The new building area that would be constructed as part of the proposed project could be subject to the effects of expansive soils. As project construction would occur in accordance with LABC Sections 91.7000 through 91.7016, which include construction requirements for grading, excavation, and foundation work, the potential for hazards to occur as a result of expansive soils would be minimized. The design and construction of the proposed project would comply with current UBC requirements and would not substantially affect the foundation or result in other structural or engineering modifications that could increase exposure of people or structures to risk associated with expansive soils. The impact would be less than significant, and no mitigation is required.

e. Have soils incapable of adequately supporting the use of septic tanks or alternative wastewater disposal systems where sewers are not available for the disposal of wastewater?

No Impact. The project site is located in an urbanized area where wastewater infrastructure is currently in place. The proposed project would not use septic tanks or alternative wastewater disposal systems. Therefore, no impacts related to the ability of onsite soils to support septic tanks or alternative wastewater systems would occur with implementation of the proposed project, and no mitigation is required.

³³ City of Los Angeles, LAWA, Final Environmental Impact Report, Los Angeles International Airport Proposed Master Plan Improvements, Section 4.22, April 2004.

³⁴ City of Los Angeles, Final Environmental Impact Report for Los Angeles International Airport (LAX) Proposed Master Plan Improvements, Section 4.22, April 2004.

³⁵ City of Los Angeles, Final Environmental Impact Report for Los Angeles International Airport (LAX) Proposed Master Plan Improvements, Section 4.22, April 2004.

VII. GREENHOUSE GAS EMISSIONS. *Would the project:*

a. Generate greenhouse gas emissions, either directly or indirectly, that may have a significant impact on the environment?

Less Than Significant Impact. The proposed project could generate greenhouse gas (GHG) emissions from vehicle exhaust associated with construction-related activities, including off-road construction equipment, construction worker commuting, and haul/vendor truck trips. The proposed project would not affect operations at Terminal 1; therefore, operational emissions were not evaluated.

The SCAQMD Governing Board adopted its staff proposal for an interim CEQA GHG significance threshold for industrial projects where SCAQMD is the lead agency. This threshold is 10,000 metric tons of carbon dioxide equivalent per year (MTCO₂eq/yr). The SCAQMD staff-proposed thresholds for residential and commercial developments, including industrial parks and warehouses, is 3,000 MTCO₂eq/yr; however, the threshold was not adopted by the SCAQMD Board. For the purposes of this analysis, the 10,000 MTCO₂eq/yr threshold was used.

GHG emissions for the proposed project were estimated using the CARB on-road motor vehicle emission factor model (EMFAC2011), CARB off-road motor vehicle emission factor model (OFFROAD2007), CARB In-Use Off-Road Equipment 2011 Inventory Model, and assumptions built into California Emissions Estimator Model (CalEEMod), Version 2013.2.2.^{36,37,38,39} Table 7 summarizes emissions from the proposed improvements.

Table 7				
Greenhouse Gas Emissions Summary from Proposed Project				
Year	Emissions (metric tons per year)			
	CO₂	CH₄	N₂O	CO₂e
2014	1,387	<1	<1	1,397
2015	2,435	<1	<1	2,452
2016	2,412	<1	<1	2,429
2017	1,744	<1	<1	1,756

Key:

CH₄ = methane

CO₂ = carbon dioxide

CO₂e = carbon dioxide equivalent

N₂O = nitrous oxide

Source: CDM Smith 2014.

³⁶ California Air Resources Board, EMFAC Emissions Database, Available: <http://www.arb.ca.gov/emfac/>, accessed December 27, 2013.

³⁷ California Air Resources Board, Mobile Source Emissions Inventory - - EMFAC2011-LDV Homepage, Available: http://www.arb.ca.gov/msei/emfac2011_ldv.htm, accessed December 19, 2013.

³⁸ California Air Resources Board, Off-Road Motor Vehicles Homepage, Available: http://www.arb.ca.gov/msei/categories.htm#offroad_motor_vehicles, accessed December 27, 2013.

³⁹ California Air Pollution Control Officers Association, California Emissions Estimator Model (CalEEMod) Homepage, Available: <http://www.caleemod.com/>, accessed December 27, 2013.

The SCAQMD recommends that construction emissions be amortized over the project lifetime (i.e. 30 years) and then be added to operational emissions so that GHG emission reduction measures also capture construction.⁴⁰ Because operational emissions were not required to be evaluated, only construction emissions were compared against the threshold. The annual GHG emissions are well below the 10,000 MTCO₂eq/yr threshold, even without amortizing.

The proposed project would not change the basic operation of the terminal. However, the project would be designed with features to reduce emissions, including gates with 400 Hz power, pre-conditioned air, and potable water equipment, as well as new energy efficient battery chargers to accommodate an all-electric GSE program. The proposed project would be designed and constructed in accordance with CALGreen Tier 1 standards. Actual emissions may be lower than calculated, as sustainable design features to reduce energy and electricity use would be implemented.

As GHG emissions from the proposed project would be less than the SCAQMD adopted significance threshold, the impact is less than significant, and no mitigation is required.

b. Conflict with an applicable plan, policy or regulation adopted for the purpose of reducing the emissions of greenhouse gases?

Less Than Significant Impact. As discussed in Response VII.a above, GHG emissions that would occur from construction of the proposed project would be less than the SCAQMD-adopted thresholds of significance. As a result, GHG emissions from the proposed project would not conflict with Assembly Bill 32, the purpose of which is to reduce statewide GHG emissions to 1990 levels by 2020. Therefore, the impact is less than significant, and no mitigation is required.

VIII. HAZARDS AND HAZARDOUS MATERIALS. *Would the project:*

a. Create a significant hazard to the public or the environment through the routine transport, use, or disposal of hazardous materials?

b. Create a significant hazard to the public or the environment through reasonably foreseeable upset and accident conditions involving the release of hazardous materials into the environment?

a-b. Less Than Significant Impact. The proposed project would not result in any changes in the use of hazardous materials at the project site. The proposed project involves renovation and modernization of an existing terminal. Construction of the proposed project would involve some use of hazardous materials, including vehicle fuels, oils, transmission fluids, cleaning solvents, and architectural coatings. In addition, some asbestos-containing floor tile mastic and lead-based paint would be removed. These types of materials are not acutely hazardous, and storage, handling, and disposal of these materials are strictly regulated. Compliance with existing federal, state and local regulations and routine precautions would reduce the potential for accidental releases of a hazardous material to occur and would minimize the impact of an accident should one occur. As such, construction and operation of the proposed project would not create a significant hazard to the public or the environment through the routine transport, use, or disposal of hazardous materials nor create a significant hazard to the public or the environment through reasonably foreseeable upset and accident conditions involving the release of hazardous materials into the environment. The impact would be

⁴⁰ South Coast Air Quality Management District, Draft Guidance Document – Interim CEQA Greenhouse Gas (GHG) Significance Threshold, October 2008.

less than significant and no mitigation is required.

c. Emit hazardous emissions or handle hazardous or acutely hazardous materials, substances, or waste within one-quarter mile of an existing or proposed school?

No Impact. As discussed in Response VIII.a-b above, a minimal increase in the handling of hazardous materials would occur during construction and no increase is expected during operation of the proposed project. However, there are no schools located or proposed within one-quarter mile of the project site. Therefore, no impacts related to the emitting of hazardous emissions or the handling of hazardous or acutely hazardous materials, substances, or waste within one-quarter mile of an existing or proposed school would occur with implementation of the proposed project, and no mitigation is required.

d. Be located on a site which is included on a list of hazardous materials sites compiled pursuant to Government Code Section 65962.5 and, as a result, would it create a significant hazard to the public or the environment?

Less Than Significant Impact. An Environmental Data Resources (EDR) regulatory database review, pursuant to Government Code Section 65962.5, was performed for all of LAX in August 2011.⁴¹ A number of sites at LAX were listed in several databases searched by EDR as having underground storage tanks (USTs) or soil and/or groundwater contamination. The project site is not included on any lists of hazardous materials sites compiled pursuant to Government Code Section 65962.5. However, the database review was supplemented by sites with known contamination that have been identified by LAWA. This list of supplemental sites includes Terminal 1.

Soil contamination by total petroleum hydrocarbons (TPH) has been detected in the Terminal 1 apron area along the subsurface fuel hydrant system. The highest concentrations were found to the north/northwest of the end of the concourse, as well as to the east. Further characterization of the site is pending.

Contamination has also been identified to the west and east of Terminal 1. Soil contamination (TPH and VOCs) have been detected in the hydrant fuel system to the north/northwest of the end of the Terminal 2 concourse. Groundwater at the Terminal 2 site may also be affected. Due to the distance of this site from the Terminal 1 construction site, contamination from Terminal 2 is not expected to have an impact on the proposed project.

The Park One (former Honeywell/Allied Signal Aerospace) site is located in close proximity to Terminal 1. The site is located immediately northeast of the CTA at the northwest corner of Century Boulevard and Sepulveda Boulevard, in an area currently used for privately-operated airport parking. Ongoing remediation efforts at the site have consisted of soil vapor extraction (SVE) to remove VOCs using a granular activated carbon system. Additional investigation of soils in the "hotspot" area in the northeast portion of the site is in progress. Groundwater moves east in this area; therefore, contamination from Park One does not pose a hazard to the proposed project site.

The proposed project would involve excavation within the Terminal 1 apron area as well as relocation of fuel hydrant pits associated with the hydrant system. Based on the known contamination in the Terminal 1 apron area, it is likely that contaminated materials would be encountered during construction. LAWA's *Procedure for the Management of Contaminated Materials Encountered During Construction* (the Procedure) requires the preparation of detailed plans for handling

⁴¹ Environmental Data Resources Inc. (EDR), EDR Data Map Area Study, Los Angeles, California, August 2011.

contaminated soil encountered during construction. It requires the preparation of health and safety and soils management plans, and includes provisions for testing and segregation of contaminated soils for proper disposal. While the Procedure focuses on previously unknown contaminated materials, its provisions for handling, storing, and disposing of contaminated materials also apply to contaminated materials that LAWA has identified before the start of construction. Compliance with LAWA's Procedure would ensure that contaminated materials encountered during construction are properly identified, stored, remediated, and disposed of in accordance with all applicable regulations, including those governing worker health and safety.

Remediation of contamination has the potential to expose workers to hazardous materials or substances. SCAQMD regulates emissions from soil remediation activities through Rule 1166, Volatile Organic Compound Emissions from Decontamination of Soil. This rule requires development and approval of a mitigation plan, monitoring of VOC concentrations, and implementation of the mitigation plan if VOC-contaminated soil is detected. Worker safety and health are also regulated by the federal Occupational Safety and Health Act (OSHA) of 1970 and the California Occupational Safety and Health Act (CalOSHA). OSHA and CalOSHA standards establish exposure limits for certain air contaminants. Exposure limits define the maximum amount of hazardous airborne chemicals to which an employee may be exposed over specific periods. When administrative or engineering controls cannot achieve compliance with exposure limits, protective equipment or other protective measures must be used. Employers are also required to provide a written health and safety program, worker training, emergency response training, and medical surveillance.

Compliance with the Procedure and with regulations governing remediation of contaminated materials would ensure that implementation of the proposed project on a site with known contamination would not create a significant hazard to the public or the environment. This impact would be less than significant, and no mitigation is required.

e. For a project located within an airport land use plan or, where such a plan has not been adopted, within two miles of a public airport or public use airport, would the project result in a safety hazard for people residing or working in the project area?

Less Than Significant Impact. The project site is located within a public airport. Numerous safeguards are required by law to minimize the potential for and the effects from an accident if one were to occur. FAA's Airport Design Standards establish, among other things, land use related guidelines to protect people and property on the ground, including establishment of safety zones that keep areas near runways free of objects that could interfere with aviation activities. City of Los Angeles Ordinance No. 132,319 regulates building height limits and land uses within the Hazard Area established by the Planning and Zoning Code to protect aircraft approaching and departing from LAX from obstacles. In addition to the many safeguards required by law, LAWA and tenants of LAX maintain emergency response and evacuation plans that also serve to minimize the potential for and the effects of an accident.

The proposed project would be designed to ensure that airplanes exiting and entering the site could do so safely without posing a risk to other aircraft or vehicles and that adequate maneuvering area is provided. In addition, construction activities would be coordinated with FAA through the use of Form FAA 7460-1 (Notice of Proposed Construction or Alteration), which requires that any potential hazards to air navigation be addressed. All construction activities would comply with applicable aviation-related safeguards, and thus would not create a safety hazard. Therefore, impacts

to safety for people working or residing in the project area would be less than significant, and no mitigation is required.

f. For a project within the vicinity of a private airstrip, would the project result in a safety hazard for the people residing or working in the project area?

No Impact. The project site is not located within the vicinity of a private airstrip but rather within a public airport. See Response VIII.e above. Therefore, implementation of the proposed project would not result in a safety hazard for people residing or working within the vicinity of a private airstrip. No impact would occur with implementation of the proposed project, and no mitigation is required.

g. Impair implementation of or physically interfere with an adopted emergency response plan or emergency evacuation plan?

Less Than Significant Impact. LAWA and tenants of LAX maintain emergency response and evacuation plans to minimize the potential for and the effects of an accident, should one occur. The construction staging areas would comply with LAWA and FAA guidelines and procedures that are in place to limit the impacts of construction at the airport, including the potential to affect emergency response. Construction of the proposed project is not anticipated to result any closures to local airport circulation roads or lanes within the CTA. Emergency access routes in the vicinity of the project site would be kept clear and unobstructed at all times in accordance with FAA, State Fire Marshal, and Los Angeles Fire Code regulations. Following completion of construction, there would be no change in the use of the facility. However, the reconfiguration of the curb in front of Terminal 1 would reduce traffic congestion on World Way North and back-ups onto Sky Way that frequently occur in this location. These changes would improve access for emergency vehicles and would enhance emergency response and evacuation within the CTA. Therefore, construction-related impacts related to emergency response plans or emergency evacuation plans would be less than significant with the implementation of the proposed project and, following completion of construction, long-term impacts would be beneficial; no mitigation is required.

h. Expose people or structures to a significant risk of loss, injury, or death involving wildland fires, including where wildlands are adjacent to urbanized areas or where residences are intermixed with wildlands?

No Impact. The project site is located within a developed airport and surrounded by airport uses, urbanized areas, and the Los Angeles/El Segundo Dunes. There are no fire hazard areas containing flammable brush, grass, or trees on the project site. Furthermore, the project site is not within a City of Los Angeles Wildfire Hazard Area, as delineated in the Safety Element of the General Plan.⁴² Therefore, implementation of the proposed project would not result in the exposure of people or structures to hazards associated with wildland fires, and no mitigation is required.

IX. HYDROLOGY AND WATER QUALITY. *Would the project:*

a. Violate any water quality standards or waste discharge requirements?

Less Than Significant Impact. The agency with jurisdiction over water quality within the project area is the Los Angeles Regional Water Quality Control Board (LARWQCB). The Clean

⁴² City of Los Angeles, Department of City Planning, Safety Element of the City of Los Angeles General Plan, Exhibit D, Selected Wildfire Hazard Areas In the City of Los Angeles, April 1996.

Water Act (CWA) prohibits the discharge of pollutants to waters of the United States from any point source unless the discharge is in compliance with a National Pollutant Discharge Elimination System (NPDES) permit. In accordance with the CWA, the project site is within the region covered by NPDES Permit No. CAS004001 issued by the LARWQCB. As part of the storm water program associated with the NPDES Phase 1 Permit, LARWQCB adopted the Standard Urban Storm Water Mitigation Plan (SUSMP) to address storm water pollution from new development and redevelopment projects. A recent change to the permit puts primary emphasis on Low Impact Development (LID) practices over treatment control BMPs. The Stormwater LID Ordinance approved by the City of Los Angeles outlines requirements for providing LID strategies for new development and redevelopment project.

Implementation of the proposed project would not result in an increase in impervious surfaces, as the site is currently fully paved. However, construction would result in site disturbance associated with the replacement of the aircraft parking ramp pavement. The total area of pavement to be replaced is approximately 10.6 acres. Construction is planned to occur over 9 phases; approximately 1.2 acres would be disturbed during each phase. These construction activities would require preparation of a Storm Water Pollution Prevention Plan (SWPPP) to address construction-related surface water quality impacts and delineate water quality control measures (i.e., Best Management Practices or BMPs) and/or LID practices to address those impacts. Temporary construction BMPs specified in LAWA's existing Construction SWPPP for LAX include, but are not limited to, the following: soil stabilization (erosion control) techniques; sediment control methods; contractor training programs; material transfer practices; waste management practices; roadway cleaning/tracking control practices; vehicle and equipment practices; and fueling practices.

As noted above, construction of the proposed project would occur on a site that is currently developed and fully paved. The proposed project and associated facilities would not materially alter existing drainage patterns or surface water runoff quantities on the project site and would not violate any water quality standards or waste discharge requirements. Therefore, impacts related water quality would be less than significant with implementation of the proposed project, and no mitigation is required.

b. Substantially deplete groundwater supplies or interfere substantially with groundwater recharge such that there would be a net deficit in aquifer volume or a lowering of the local groundwater table level (e.g., the production rate of pre-existing nearby wells would drop to a level which would not support existing land uses or planned land uses for which permits have been granted)?

No Impact. The project site is located within the West Coast Groundwater Basin. Groundwater beneath the project site is not used for municipal or agricultural purposes.⁴³ Construction and operation of the proposed project would not involve dewatering and, thus, would not deplete groundwater supplies. Moreover, the proposed project would not increase the amount of impervious surface on the site. Therefore, no impacts to groundwater supplies or groundwater recharge would occur with the implementation of the proposed project, and no mitigation is required.

⁴³ City of Los Angeles, Final Environmental Impact Report for Los Angeles International Airport (LAX) Proposed Master Plan Improvements, Section 4.7, April 2004.

-
- c. Substantially alter the existing drainage pattern of the site or area, including through the alteration of the course of a stream or river, in a manner which would result in substantial erosion or siltation on- or off-site?**
 - d. Substantially alter the existing drainage pattern of the site or area, including through the alteration of the course of a stream or river, or substantially increase the rate or amount of surface runoff in a manner which would result in flooding on- or off-site?**
 - e. Create or contribute runoff water which would exceed the capacity of existing or planned stormwater drainage systems or provide substantial additional sources of polluted runoff?**
 - f. Otherwise substantially degrade water quality?**

c-f. Less Than Significant Impact. As noted in Response IX.a above, the proposed project would be constructed on a site that is currently fully impervious. Implementation of the proposed project would not alter drainage patterns in a manner that would result in erosion or siltation offsite or increase the rate or amount of surface runoff in a manner that would result in flooding on- or offsite. Moreover, with implementation of a SWPPP and compliance with regulatory requirements, the project would not substantially degrade water quality. Therefore, impacts to water quality with implementation of the proposed project would be less than significant, and no mitigation is required.

- g. Place housing within a 100-year flood hazard area as mapped on a federal Flood Hazard Boundary or Flood Insurance Rate Map or other flood hazard delineation map?**

- h. Place within a 100-year flood hazard area structures which would impede or redirect flood flows?**

g-h. No Impact. No 100-year floodplain areas are located within LAX.⁴⁴ Further, the proposed project does not involve the construction of housing. Therefore, no impacts resulting from the placement of housing or other structures within a 100-year floodplain would occur, and no mitigation is required.

- i. Expose people or structures to a significant risk of loss, injury or death involving flooding, including flooding as a result of the failure of a levee or dam?**

No Impact. Please see Response IX.g-h above. In addition, as delineated on the City of Los Angeles Inundation and Tsunami Hazard Areas map,⁴⁵ the project site is not within a boundary of an inundation area from a flood control basin, nor is it located within the downstream influence of any levee or dam. Therefore, no impacts due to the exposure of people or structures to a risk of loss, injury, or death involving flooding as a result of the failure of a levee or dam would occur, and no mitigation is required.

- j. Inundation by seiche, tsunami, or mudflow?**

No Impact. The project site is approximately 2.3 miles east of the Pacific Ocean and is not delineated as a potential inundation or tsunami impacted area in the City of Los Angeles Inundation

⁴⁴ City of Los Angeles, Final Environmental Impact Report for Los Angeles International Airport (LAX) Proposed Master Plan Improvements, Section 4.13, April 2004.

⁴⁵ City of Los Angeles, Department of City Planning, Safety Element of the City of Los Angeles General Plan, Exhibit G, Inundation & Tsunami Hazard Areas in the City of Los Angeles, March 1994.

and Tsunami Hazard Areas map.⁴⁶ Mudflows are not a risk as the project site is located on, and is surrounded by, relatively level terrain and urban development. Therefore, no impacts resulting from inundation by seiche, tsunami, or mudflow would occur with the implementation of the proposed project, and no mitigation is required.

X. LAND USE AND PLANNING. *Would the project:*

a. Physically divide an established community?

No Impact. The project site is located entirely within the boundaries of a developed airport in an urbanized area and modernization of existing Terminal 1 within the airport would not disrupt or divide the physical arrangement of an established community. Therefore, no impacts resulting from physically dividing an established community would occur with the implementation of the proposed project, and no mitigation is required.

b. Conflict with applicable land use plan, policy or regulation of an agency with jurisdiction over the project (including but not limited to the general plan, specific plan, local coastal program, or zoning ordinance) adopted for the purpose of avoiding or mitigating an environmental effect?

No Impact. Land use designations and development regulations applicable to LAX are set forth in the LAX Plan⁴⁷ and LAX Specific Plan,⁴⁸ both approved by the Los Angeles City Council in December 2004 and subsequently amended. The project site is in an area designated in the LAX Plan as "Airport Airside." Within the LAX Specific Plan, the site is in an area designated as within the Airport Airside Sub-Area and zoned LAX – A Zone: Airport Airside Sub-Area. Section 9.B of the LAX Specific Plan delineates the permitted uses within the Airport Airside Sub-Area. Of the numerous uses listed, the following permitted uses are located in the proposed project area:

- Airline clubs, retail uses, and restaurants
- Establishments for the sale and service of alcoholic beverages for on-site and off-site consumption
- Incidental retail uses - permanent or temporary retail uses, which may include kiosks and carts
- Passenger handling facilities, including but not limited to baggage handling and processing, passenger holdrooms, boarding gates, ticketing and passenger check-in functions
- Aircraft under power
- Runways, taxiways, aircraft parking areas, and service roads
- Passenger handling facilities, including but not limited to baggage handling and processing, passenger holdrooms, boarding gates, ticketing, and passenger check-in functions
- Security-related equipment and facilities
- Uses customarily incident to any of the above uses, and accessory buildings or uses

⁴⁶ City of Los Angeles, Department of City Planning, Safety Element of the City of Los Angeles General Plan, Exhibit G, Inundation & Tsunami Hazard Areas in the City of Los Angeles, November 1996.

⁴⁷ City of Los Angeles, LAX Plan, September 29, 2004, as amended.

⁴⁸ City of Los Angeles, Los Angeles International Airport Specific Plan, September 29, 2004, as amended.

The proposed project includes the renovation and modernization of Terminal 1. The proposed project represents near-term improvements that would enhance the efficient operation and level of passenger service at Terminal 1. The proposed improvements are consistent with the LAX Plan land use designation and with the allowable uses under the LAX Specific Plan. Therefore, the proposed project would not conflict with applicable the land use plan, policy or regulation of an agency with jurisdiction over the project (including but not limited to the general plan, specific plan, coastal program, or zoning ordinance) adopted for the purpose of avoiding or mitigating an environmental effect. Moreover, implementation of the proposed project would be consistent with the existing permitted uses. No impact or conflict with an applicable land use plan, policy or regulation would occur with the implementation of the proposed project, and no mitigation is required.

c. Conflict with any applicable habitat conservation plan or natural community conservation plan?

No Impact. The Dunes Specific Plan Area, a designated Los Angeles County Significant Ecological Area, is located approximately 2 miles to the west of the proposed project site, opposite Pershing Drive. The proposed project would be located within an urbanized airport area within and adjacent to existing airport uses and would not affect the Dunes Specific Plan Area. There is no adopted Habitat Conservation Plan, Natural Community Conservation Plan, or other approved habitat conservation plan or other natural community conservation plan that includes the project site. Therefore, no impacts to, or conflict with, any habitat or natural community conservation plans would occur with the implementation of the proposed project, and no mitigation is required.

XI. MINERAL RESOURCES. *Would the project:*

a. Result in the loss of availability of a known mineral resource that would be of value to the region and the residents of the state?

No Impact. The State Mining and Geology Board classifies mineral resource zones throughout the State. The project site is contained within an MRZ-3 zone, which represents areas with mineral deposits whose significance cannot be evaluated from available data.⁴⁹ The project site is within the boundaries of the airport and surrounded by airport-related uses. There are no actively-mined mineral or timber resources on the project site, nor is the site available for mineral resource extraction given the existing airport use. Therefore, no impacts related to the loss of availability of a known valued mineral resources would occur with the implementation of the proposed project, and no mitigation is required.

b. Result in the loss of availability of a locally-important mineral resource recovery site delineated on a local general plan, specific plan, or other land use plan?

No Impact. The project site is not within an area delineated on the City of Los Angeles Oil Field & Oil Drilling Areas map in the City of Los Angeles General Plan Safety Element.⁵⁰ Furthermore, the project site is disturbed and in an area that is not available for mineral resource extraction due to the existing airport use. Therefore, no impacts related the availability of a locally-

⁴⁹ City of Los Angeles, Final Environmental Impact Report for Los Angeles International Airport (LAX) Proposed Master Plan Improvements, Section 4.17, April 2004.

⁵⁰ City of Los Angeles, Department of City Planning, Safety Element of the City of Los Angeles General Plan, Exhibit E, Oil Field & Oil Drilling Areas in the City of Los Angeles, May 1994.

important mineral resource recovery site would occur with the implementation of the proposed project, and no mitigation is required.

XII. NOISE. *Would the project result in:*

- a. Exposure of persons to or generation of noise levels in excess of standards established in the local general plan or noise ordinance, or applicable standards of other agencies?**
- b. Exposure of persons to or generation of excessive groundborne vibration or groundborne noise levels?**
- c. A substantial permanent increase in ambient noise levels in the project vicinity above levels existing without the project?**
- d. A substantial temporary or periodic increase in ambient noise levels in the project vicinity above levels existing without the project?**

a-d. Less Than Significant Impact. The proposed project involves the renovation and modernization of Terminal 1. The project site is within a public airport in an urban environment that operates 24 hours a day, seven days a week, and 365 days a year, with many existing sources of noise, including aviation noise and traffic noise. Construction of the proposed project, which would involve the use of various pieces of equipment, would result in a temporary increase in ambient noise levels immediately adjacent to the project site. Noise levels from outdoor construction activities, independent of background ambient noise levels, indicate that the noisiest phases of construction are typically during excavation and grading, and that noise levels from equipment with mufflers are typically 86 A-weighted decibels (dBA) in equivalent A-weighted sound level (L_{eq}) at 50 feet from the noise source. This type of sound typically dissipates at a rate of 4.5 dBA to 6.0 dBA for each doubling of distance. For the noise analysis of the proposed project, the more conservative attenuation rate of 4.5 dBA was used. As such, a sound level of 86 dBA at 50 feet from the noise source would be approximately 81.5 dBA at a distance of 100 feet, 77 dBA at a distance of 200 feet, and so on. That sound drop-off rate does not take into account any intervening shielding or barriers such as structures or hills between the noise source and noise receptor.

Development and operation of the proposed project would occur in an area generally removed from the communities near LAX. The nearest noise-sensitive land use is residential development approximately 3,050 feet to the northeast in Westchester. Based on a noise attenuation rate of 4.5 dBA per doubling of distance, the noise levels from construction activities within the project site would be approximately 59.4 dBA L_{eq} at the closest residences in Westchester. The existing daytime ambient noise level at the nearest sensitive receptor (i.e., residential development in Westchester north of Lot C) is approximately 70 dBA L_{eq} or higher,⁵¹ with the nighttime ambient noise level being approximately 5 dBA lower. In accordance with the L.A. CEQA Thresholds Guide, construction activities are considered to have a significant impact relative to construction noise if construction activities lasting more than ten days in a three month period would exceed baseline ambient exterior noise levels by 5 dBA or more at a noise-sensitive use.⁵² Construction activities would occur in two

⁵¹ City of Los Angeles, Los Angeles World Airports (LAWA), LAWA Noise Management, California State Airport Noise Standards Quarterly Report, Second Quarter 2013, Available at: <http://www.lawa.org/uploadedFiles/LAX/pdf/2Q13%20QuarterlyReport%20map.pdf>, accessed on February 4, 2014.

⁵² City of Los Angeles, L.A. CEQA Thresholds Guide, Your Resource for Planning CEQA Analysis in Los Angeles, 2006.

shifts: Shift 1 would run from 10:00 pm to 6:30 am and Shift 2 would begin at 6:00 am and end at 2:30 pm. The noise level from construction activity within the project site would not exceed the existing daytime or nighttime ambient noise level at any residences and, in fact, would be lower than existing ambient noise levels.

With regard to roadway noise associated with construction traffic on area roads, traffic volumes on roads with good operating conditions (i.e., Level of Service B or better) would have to increase at more than a three-fold rate to reach the City's threshold of significance of a 5 dBA increase, and would need to increase even more on roads with poor operating conditions (i.e., Level of Service C or worse). Traffic on Century Boulevard west of Avion Drive has approximately 67,000 average daily trips (based on 2/18/10 traffic counts) and traffic on Sepulveda Boulevard north of Interstate 105 has approximately 122,000 average daily trips (based on 8/14/08 traffic counts).⁵³ Project-related construction activities would not approach the number of trips required to result in a three-fold increase on any area roads. Therefore, the proposed project would not result in a noise level increase that would exceed the threshold of significance.

As indicated previously, implementation of the proposed project would not result in an increase in activity within LAX, or an increase in aircraft operations. Therefore, operation of the proposed project would not generate any additional noise, nor would it increase the number of daily flights arriving and departing from LAX or the ambient growth in aviation activity at LAX that is projected to occur in the future. Implementation of the proposed project would not expose persons to, or result in the generation of, noise in levels in excess of standards established in the local general plan or noise ordinance or applicable standards of other agencies; expose people to, or result in the generation of, excessive groundborne vibration or groundborne noise levels; create a substantial permanent increase in ambient noise levels in the project vicinity above levels existing without the project; or create a substantial temporary or periodic increase in ambient noise levels in the project vicinity above levels existing without the project.

In summary, impacts related to construction and operational noise would be less than significant with implementation of the proposed project, and no mitigation is required.

e. For a project located within an airport land use plan or, where such a plan has not been adopted, within two miles of a public airport or public use airport, would the project expose people residing or working in the project area to excessive noise levels?

No Impact. Implementation of the proposed project involves the renovation and modernization of Terminal 1. Although there would be a minor and temporary increase in ambient noise levels during construction, operation of the proposed project would not increase passenger or aircraft operations. Therefore, implementation of the proposed project would not result in any impacts relative to the exposure of people residing or working in the project area to excessive noise from a project located within an airport land use plan, and no mitigation is required.

⁵³ City of Los Angeles, Department of Transportation, [Traffic Counts Conducted by LADOT's Traffic Survey Section, 10-Year Summary 2001-2010](http://ladot.lacity.org/WhatWeDo/TrafficVolumeCounts/CurrentCountData/index.htm), Available at: [http://ladot.lacity.org/WhatWeDo/TrafficVolumeCounts/CurrentCountData/index htm](http://ladot.lacity.org/WhatWeDo/TrafficVolumeCounts/CurrentCountData/index.htm), accessed on February 4, 2014.

f. For a project within the vicinity of a private airstrip, would the project expose people residing or working in the project area to excessive noise levels?

No Impact. The project site is within a public airport and not located within the vicinity of a private airstrip. Therefore, no impact would occur relative to the exposure of people residing or working in the project area to excessive noise levels from a private airstrip with the implementation of the proposed project, and no mitigation is required.

XIII. POPULATION AND HOUSING. *Would the project:*

a. Induce substantial population growth in an area either directly (for example, by proposing new homes and businesses) or indirectly (for example, through extension of roads or other infrastructure)?

No Impact. The proposed project does not include residential development. Moreover, the project would not increase existing passenger capacity or aircraft parking capacity at LAX. The proposed project would marginally increase long-term employment opportunities at LAX through the increase in concessions within the terminal. These jobs are expected to be filled from the large southern California regional population and would not induce population growth in the area. The project site is located within a developed airport; no new roads or extensions of existing roads or other growth-accommodating infrastructure are proposed. Therefore, the proposed project would not directly or indirectly induce substantial population growth directly or indirectly through extension of roads or other infrastructure, and no mitigation is required.

b. Displace substantial numbers of existing housing necessitating the construction of replacement housing elsewhere?

c. Displace substantial numbers of people necessitating the construction of replacement housing elsewhere?

b-c. No Impact. There are no existing residential properties on the project site. Implementation of the proposed project would not displace housing. Therefore, no impacts on housing would occur with the implementation of the proposed project, and no mitigation is required.

XIV. PUBLIC SERVICES. *Would the project result in substantial adverse physical impacts associated with the provision of new or physically altered governmental facilities, construction of which could cause significant environmental impacts, in order to maintain acceptable service ratios, response times or other performance objectives for any of the public services?*

a. Fire protection?

No Impact. The City of Los Angeles Fire Department (LAFD) provides fire protection services to the project site. Three LAFD fire stations are located at LAX (Fire Station Nos. 80, 51, and 95). Fire Station No. 80, located at 6911 World Way West, is approximately 0.75 mile east of the project site; Fire Station No. 51, located at 10435 South Sepulveda Boulevard, is approximately 0.4 mile southeast of the project site; and Fire Station No. 95, located at 10010 International Road, is approximately 1 mile east of the project site. In addition, Fire Station No. 5, located at 8900 Emerson Avenue, approximately 0.5 mile north of the project site, also serves LAX.⁵⁴ Construction of the

⁵⁴ City of Los Angeles, Final Environmental Impact Report for Los Angeles International Airport (LAX) Proposed Master Plan Improvements, Section 4.26.1, April 2004.

proposed project would not result in temporary closures or partial closures to local airport circulation roads. Access to the project site during construction would be kept clear and unobstructed at all times in accordance with FAA, State Fire Marshal, and Los Angeles Fire Code regulations.

Fire service requirements are generally based on the size of the building and relationships to other structures and property lines. The project site is currently developed and the boundary of the proposed project would not extend beyond the current leasehold boundary. The proposed project would comply with all applicable city, state, and federal codes and ordinances, including LAFD and Los Angeles Building and Safety requirements. Implementation of the proposed project would not result in an increase in demand for fire protection services that may result in the need for new or altered fire protection services, nor would it affect response times which could lead to a substantial adverse physical impact. Therefore, no impacts on fire protection services would occur with implementation of the proposed project, and no mitigation is required.

b. Police protection?

Less Than Significant Impact. Both the Los Angeles World Airports Police Division (LAWA PD) and the City of Los Angeles Police Department LAX Detail (LAPD LAX Detail) provide police protection services to the project site. The LAWA PD station is located north of Park One, east of the project site, and the LAPD LAX Detail station is located within the CTA. Demand for on-airport police protection services is typically determined by increases in passenger activity and employees. Implementation of the proposed project involves the renovation and modernization of Terminal 1. The proposed project would not alter passenger activity at Terminal 1, and would not substantially increase long-term employment or result in indirect growth that would result in need for additional police protection. Therefore, impacts to police protection with implementation of the proposed project would be less than significant, and no mitigation is required.

c. Schools?

No Impact. Implementation of the proposed project involves the renovation and modernization of Terminal 1. The proposed project would not include residential development and would not increase existing passenger capacity or substantially increase long-term employment such that indirect growth would result in enrollment increases that would adversely impact schools. Therefore, no impacts to, or need for, new school facilities would occur with implementation of the proposed project, and no mitigation is required.

d. Parks?

No Impact. Implementation of the proposed project involves the renovation and modernization of Terminal 1. The proposed project would not include residential development and would not increase existing passenger capacity or substantially increase long-term employment such that indirect growth would result in increased demand for neighborhood or regional parks. Therefore, no impacts to, or need for, new parks would occur from implementation of the proposed project, and no mitigation is required.

e. Other governmental services (including roads)?

No Impact. Implementation of the proposed project would have no adverse impacts on governmental services, including roads. The project would increase the space available for passenger security screening with the addition of a new 12-lane Security Screening Check Point (SCCP), which would eliminate the need for passengers to queue outside the building, thereby removing a target of

opportunity created when a large volume of passengers are waiting curbside. In addition, a new, fully automated in-line baggage screening system would be constructed, which would increase the efficiency of the screening process and screened bag throughput, while reducing the number of on-the-job injuries as well as creating a safer working environment for TSA personnel. The Arrivals Level would be reconfigured to accommodate a new Checked Baggage Inspection System (CBIS), which would enhance the efficiency and capabilities of the TSA. These improvements would be beneficial impacts related to the provision of governmental services, and no mitigation is required.

XV. RECREATION.

- a. Would the project increase the use of existing neighborhood and regional parks or other recreational facilities such that substantial physical deterioration of the facility would occur or be accelerated?**
- b. Does the project include recreational facilities or require the construction or expansion of recreational facilities which might have an adverse physical effect on the environment?**

a-b. No Impact. The proposed project does not include development of recreational facilities nor does it include residential development. The proposed project would not increase existing passenger capacity at LAX or substantially increase long-term employment such that increased demand for neighborhood and regional parks or other recreational facilities would occur. Therefore, the proposed project would not result in substantial physical deterioration of existing area recreational facilities or require the construction or expansion of recreational facilities. As such, no impacts related to recreation facilities would occur with the implementation of the proposed project, and no mitigation is required.

XVI. TRANSPORTATION/TRAFFIC. *Would the project:*

- a. Conflict with an applicable plan, ordinance or policy establishing measures of effectiveness for the performance of the circulation system, taking into account all modes of transportation including mass transit and non-motorized travel and relevant components of the circulation system, including but not limited to intersections, streets, highways and freeways, pedestrian and bicycle paths, and mass transit?**
- b. Conflict with an applicable congestion management program, including, but not limited to level of service standards and travel demand measures, or other standards established by the county congestion management agency for designated roads or highways?**

a-b. Less Than Significant Impact. Construction of the proposed project would generate traffic on local roads and changes to the Terminal 1 curbside would alter traffic patterns in the CTA. These impacts are discussed below.

Construction Traffic Impacts

Construction of the proposed project would generate traffic associated with workers traveling to and from the construction employee parking area, truck haul/delivery trips, and miscellaneous construction-related travel. As indicated in Section 5.0, Project Description, construction work would occur in two shifts per day: 6:00 am to 2:30 pm and 10:00 pm to 6:30 am. As a result, construction workers would not be driving on area roadways during peak traffic periods. Construction deliveries

and haul trips would average one per hour. In addition, in accordance with proposed project design features (listed below), deliveries would be scheduled during non-peak traffic hours whenever possible. Construction-related trips would not be sufficient to result in noticeable traffic impacts on the local roadway system during the construction period.

Construction of the proposed project would not result in lane closures and roadways within the landside and airside areas of the project area would be kept clear and unobstructed at all times in accordance with FAA, State Fire Marshal, and Los Angeles Fire Code regulations, and thereby would not create a significant impact. In addition, LAWA has several standard construction policies that would further reduce the potential for impacts. Following are those LAWA construction policies that are applicable to the proposed project and were assumed in the analysis herein:

◆ **Non-Peak CTA Deliveries.**

Deliveries to the CTA terminal reconstruction projects will be limited to non-peak traffic hours whenever possible.

◆ **Construction Deliveries.**

Construction deliveries requiring lane closures shall receive prior approval from the Construction Coordination Office. Notification of deliveries shall be made with sufficient time to allow for any modifications to approved traffic detour plans.

◆ **Designated Truck Delivery Hours.**

Truck deliveries shall be encouraged to use night-time hours and shall avoid the peak periods of 7:00 a.m. to 9:00 a.m. and 4:30 p.m. to 6:30 p.m.

◆ **Construction Employee Shift Hours.**

Shift hours that do not coincide with the heaviest commuter traffic periods (7:00 a.m. to 9:00 a.m., 4:30 p.m. to 6:30 p.m.) will be established. Work periods will be extended to include weekends and multiple work shifts, to the extent possible and necessary.

◆ **Construction Traffic Management Plan.**

A complete construction traffic plan will be developed to designate detour and/or haul routes, variable message and other sign locations, communication methods with airport passengers, construction deliveries, construction employee shift hours, construction employee parking locations and other relevant factors.

◆ **Designated Truck Routes.**

For dirt and aggregate and all other materials and equipment, truck deliveries will be on designated routes only (freeways and non-residential streets). Every effort will be made for routes to avoid residential frontages. The designated routes on City of Los Angeles streets are subject to approval by LADOT's Bureau of Traffic Management and may include, but will not necessarily be limited to: Pershing Drive (Westchester Parkway to Imperial Highway); Florence Avenue (Aviation Boulevard to I-405); Manchester Boulevard (Aviation Boulevard to I-405); Aviation Boulevard (Manchester Avenue to Imperial Highway); Westchester Parkway/Arbor Vitae Street (Pershing Drive to I-405); Century Boulevard (Sepulveda Boulevard to I-405); Imperial Highway (Pershing Drive to I-405); La Cienega Boulevard (north of Imperial Highway); Airport Boulevard (Arbor

Vitae Street to Century Boulevard); Sepulveda Boulevard (Westchester Parkway to Imperial Highway); I-405; and I-105.

◆ **Require CTA Construction Vehicles to Use Designated Lanes.**

Whenever feasible, construction vehicles shall be restricted to designated roadways or lanes of traffic on CTA roadways adjacent to the existing close-in parking, thus limiting the mix of construction vehicles and airport traffic.

◆ **Modify CTA Signage.**

During construction, additional signage will be installed, as required, to separate construction traffic from non-construction traffic to the extent feasible.

◆ **Ground Transportation/Construction Coordination Office Outreach Program.**

The construction coordination office shall establish appropriate mechanisms to involve and coordinate with other major airport-area development projects to the extent feasible, to ensure that the cumulative impacts of construction in the airport area are coordinated and minimized.

Operational Traffic Impacts

No increase in the future number of aircraft or passengers would occur under the proposed project. There would be a marginal increase in on-airport employees at Terminal 1 associated with new concessions. This would result in only a small increase in the number of traffic trips on local roadways that would occur periodically throughout the day and would not result in a noticeable increase in traffic volumes. Employees would be required to use employee parking areas at LAX that are located outside the CTA; therefore, employees would not utilize CTA roadways. While no increase in future traffic volumes within the CTA would occur as a result of project implementation, the proposed curbside modifications would shift traffic movement at the Terminal 1 arrivals and departures levels. To assess potential impacts associated with this shift, an analysis of potential traffic impacts within the CTA was prepared and is presented in Appendix B, Traffic Impact Evaluation. Key findings and conclusions of this analysis are summarized below.

In assessing potential operational traffic impacts associated with the proposed project, operating conditions were identified for the following scenarios at seven intersections within the CTA:

- ◆ Existing (Current) 2013 Conditions – Reflects the existing roadway configuration and traffic conditions
- ◆ Future (2017) without Project Conditions - Future traffic conditions in the year 2017 without the proposed project, reflecting future growth in passenger activity and changes operating conditions projected to occur independently of the proposed project
- ◆ Future (2017) with Project Conditions – Future traffic conditions in the CTA reflecting changes in traffic patterns due to project-related curbside modifications

The study seven intersections consist of three intersections located on the upper (departures) level and four intersections located on the lower (arrivals) level. All study intersections are controlled by traffic signals and include the following:

Upper Level Intersections

1. Sky Way and World Way North
2. West Way and World Way South
3. East Way and World Way South

Lower Level Intersections

4. Sky Way and World Way North
5. West Way and Center Way
6. East Way and Center Way
7. World Way South & Center Way

Level of service (LOS) and volume to capacity (V/C) ratio analyses were used to assess the three scenarios described above. LOS is a qualitative measure used to describe the condition of traffic flow, ranging from excellent conditions at LOS A to overloaded conditions at LOS F. LOS D is typically recognized as the minimum acceptable level of service in urban areas. Consistent with the procedures contained in LADOT's Traffic Study Policies and Procedures, the "Critical Movement Analysis-Planning", (Transportation Research Board, 1980) method of intersection capacity analysis was used to determine the intersection volume to capacity ratio and corresponding level of service at the signalized intersections.

Existing Levels of Service

The existing traffic volumes for morning (AM), midday (MD) and afternoon (PM) peak hours were used in conjunction with the level of service methodologies and the current intersection characteristics to determine the existing operating conditions at the study intersections. As shown in Table 8 below, all seven study intersections are currently operating at LOS B or better during the morning, midday and evening peak hours.

Table 8						
Existing (2013) Intersection Level of Service Analysis						
Intersection	Existing (2013) Conditions					
	AM Peak Hour		MD Peak Hour		PM Peak Hour	
	V/C	LOS	V/C	LOS	V/C	LOS
<u>Upper Level Intersections</u>						
Sky Way & World Way North	0.489	A	0.468	A	0.377	A
West Way & World Way South	0.496	A	0.472	A	0.328	A
East Way & World Way South	0.660	B	0.551	A	0.423	A
<u>Lower Level Intersections</u>						
Sky Way & World Way North	0.276	A	0.514	A	0.478	A
West Way & Center Way	0.095	A	0.320	A	0.342	A
East Way & Center Way	0.119	A	0.348	A	0.383	A
World Way South & Center Way	0.273	A	0.585	A	0.556	A

Source: Raju Associates, Inc.

Significance Thresholds

The City of Los Angeles Department of Transportation has established threshold criteria that determine if a project has a significant traffic impact at a specific signalized intersection. According to the criteria provided by the City of Los Angeles⁵⁵, a project impact is considered significant if the following conditions are met:

<u>Intersection Condition With Project Traffic</u>		<u>Project-Related Increase in V/C Ratio</u>
<u>LOS</u>	<u>V/C Ratio</u>	
C	0.701 – 0.800	Equal to or greater than 0.040
D	0.801 – 0.900	Equal to or greater than 0.020
E, F	> 0.900	Equal to or greater than 0.010

If intersections have an LOS A or B following project implementation, project impacts are considered to be less than significant.

Future (2017) without Project Conditions

Traffic projections for the Future (2017) without Project conditions reflect anticipated annual passenger growth occurring at LAX by the year 2017. Based on an overall projection of 78.9 million annual passengers (MAP) by the year 2025, the growth factor was determined to be approximately 1.9 percent per year. With the project completion date of 2017, the existing 2013 traffic volumes at each intersection were increased by 7.6 percent to reflect this growth.

The roadway network for the future base conditions within the CTA has planned improvements occurring along Center Way on the lower level, which are expected to be completed in 2014. These planned roadway network changes are included in both the Future (2017) without Project conditions and Future (2017) with Project conditions analyses.

The Future (2017) without Project peak hour traffic volumes were analyzed at each of the study intersections to determine the volume to capacity (V/C) ratio and corresponding level of service. As shown in Table 9 below, it was determined that all seven study intersections would operate at LOS B or better during the morning, midday and evening peak hours.

Future (2017) with Project Conditions

As indicated in Section 5.0, Project Description, the proposed project would relocate operations within the terminal, change access doors to the building to encourage use of the westerly doors, and relocate passenger-serving uses at the curb to the west. Together these modifications would increase the effective length of the curbside in front of Terminal 1 and would increase the vehicular queue length for passenger drop-off activity. This move would also increase the distance from the intersection of Sky Way/World Way North to the new passenger drop-off zone, thereby increasing the amount of time and distance vehicles have to merge and reach the curb. Due to these changes, on the departures level, some cars would not be able to turn left on East Way after departing the terminal. Rather, they would continue on World Way North to West Way. As a result, traffic volumes at West

⁵⁵ City of Los Angeles, Department of Transportation, *Traffic Study Policies and Procedures*, revised August 2011.

Way/World Way South would increase slightly with implementation of the Proposed Project, while traffic volumes at East Way/World Way South would decrease slightly.

On the lower (arrivals) level, shifting passenger activity to the west would also improve the curb utilization. Additional space for vehicle queues would be created for private vehicles, taxis and other services using the inner curb for passenger pick-up, which in turn would reduce congestion, and improve safety and vehicular flow. Shifting curbside demand west would also allow vehicles the option of accessing the inner curb through both the first and second access links west of the intersection of Sky Way/World Way more uniformly. Current passenger demand associated with the disproportionately high utilization of the east baggage claim area translates into very high utilization of the access link immediately (west of) the intersection, which causes roadway congestion similar to that experienced on the upper level roadway as a result of the insufficient merge distance. Shifting all baggage claim activity to the west would create an ‘active curb’ west of the center of the building, while locating the Checked Baggage Inspection System in the western half of the building would create a ‘deactivated curb’ east of the building’s center. All these modifications would result in improved merging distances, reduced congestion and, consequently, improved safety.

The net traffic expected to be shifted due to improvements by the proposed project was estimated and applied to the Future (2017) Base traffic forecasts. The Future (2017) with Project peak hour traffic volumes were analyzed to determine the volume to capacity (V/C) ratio and LOS at each of the studied intersections.

As shown in Table 9 below, under the proposed project, all seven study intersections would continue to operate at LOS B or better during the morning, midday and evening peak hours. Therefore, the proposed project would not conflict with an applicable plan, ordinance or policy establishing measures of effectiveness for the performance of the circulation system or the applicable congestion management program. The impact would be less than significant, and no mitigation is required.

Table 9							
Summary of Intersection Level of Service Analysis							
Intersection	Peak Hour	Future (2017) Base (without Project) Conditions		Future (2017) with Project Conditions		Project Increase in V/C	Significant Project Impact?
		V/C	LOS	V/C	LOS		
<i>Upper Level Intersections</i>							
Sky Way & World Way North	AM	0.526	A	0.526	A	0.000	No
	MD	0.504	A	0.504	A	0.000	No
	PM	0.406	A	0.406	A	0.000	No
West Way & World Way South	AM	0.534	A	0.548	A	0.014	No
	MD	0.508	A	0.518	A	0.010	No
	PM	0.353	A	0.361	A	0.008	No
East Way & World Way South	AM	0.689	B	0.684	B	-0.005	No
	MD	0.593	A	0.589	A	-0.004	No
	PM	0.439	A	0.436	A	-0.003	No
<i>Lower Level Intersections</i>							
Sky Way & World Way North	AM	0.296	A	0.296	A	0.000	No
	MD	0.552	A	0.552	A	0.000	No
	PM	0.514	A	0.514	A	0.000	No
West Way & Center Way	AM	0.102	A	0.102	A	0.000	No
	MD	0.259	A	0.259	A	0.000	No
	PM	0.265	A	0.265	A	0.000	No
East Way & Center Way	AM	0.129	A	0.129	A	0.000	No
	MD	0.386	A	0.386	A	0.000	No
	PM	0.340	A	0.340	A	0.000	No
World Way South & Center Way	AM	0.289	A	0.289	A	0.000	No
	MD	0.585	A	0.585	A	0.000	No
	PM	0.572	A	0.572	A	0.000	No

Source: Raju Associates, Inc.

c. Result in a change in air traffic patterns, including either an increase in traffic levels or a change in location that results in substantial safety risks?

Less Than Significant Impact. Construction of the proposed project would require the temporary closure of gates at Terminal 1. During construction, 12 gates at Terminal 1 would remain open at all times. This is consistent with the number of gates currently used by SWA, and SWA has determined that having 12 gates in operation is adequate to support planned flight operations through 2017. Therefore, no change in air traffic patterns would occur. This impact would be less than significant, and no mitigation is required.

d. Substantially increase hazards to a design feature (e.g., sharp curves or dangerous intersections) or incompatible uses (e.g., farm equipment)?

Less Than Significant Impact. Construction equipment would be required to use local roadways; however, this is not anticipated to create a safety hazard. In addition, no lane closures are anticipated that would cause or increase hazards. Design of the project is such that it would not substantially increase hazards and the project would occur at an existing terminal, which is a compatible use.

As described in Response XVI.a-b above, the proposed project would modify the location of some of the building's existing uses, which is expected to improve the utilization of the departure and arrival curbs and roadways immediately adjacent to Terminal 1 and reduce the congestion that currently occurs during peak periods. The modifications are designed to attract vehicles/passengers to locations further west and away from the intersection of Sky Way/World Way on both the upper and lower levels, thereby reducing vehicle congestion and enhancing vehicular flow past Terminal 1 and through the CTA. As discussed in Appendix B, Traffic Impact Evaluation, the modifications would result in improved merging distances, reduced congestion and, consequently, improved safety. Therefore, implementation of the proposed project would have a beneficial impact regarding roadway safety. The project would not increase hazards to a design feature or incompatible use. This impact would be beneficial, and no mitigation is required.

e. Result in inadequate emergency access?

Less Than Significant Impact. Construction of the proposed project is not anticipated to result any closures to local airport circulation roads or lanes within the CTA. Emergency access routes in the vicinity of the project site would be kept clear and unobstructed at all times in accordance with FAA, State Fire Marshal, and Los Angeles Fire Code regulations. Following completion of construction, there would be no change in the use of the facility. As discussed under Responses VIII.g and XVI.d above, utilization of the departure and arrival curbs and roadways immediately adjacent to the Terminal is expected to improve, which would reduce the congestion that currently occurs during peak periods. This would improve access for emergency vehicles and would enhance emergency response and evacuation within the CTA. Therefore, the proposed project would not result inadequate emergency access. Impacts would be less than significant and, following completion of construction, long-term impacts would be beneficial; no mitigation is required.

f. Conflict with adopted policies, plans, or programs regarding public transit, bicycle, or pedestrian facilities, or otherwise decrease the performance or safety of such facilities?

No Impact. Implementation of the proposed project is within the LAX boundary and would not conflict with, nor hinder performance of policies, plans, or programs regarding alternative forms of transportation. Therefore, no impact would occur and no mitigation is required.

XVII. UTILITIES AND SERVICE SYSTEMS. *Would the project:*

- a. Exceed wastewater treatment requirements of the applicable Regional Water Quality Control Board?**
- b. Require or result in the construction of new water or wastewater treatment facilities or expansion of existing facilities, the construction of which could cause significant environmental effects?**

a-b. No Impact. Sanitary wastewater generated by activities at the existing Terminal 1 building is treated at the Hyperion Treatment Plant. The City of Los Angeles has an approved plan to accommodate future and cumulative wastewater treatment demand and is implementing the components that comprise its plan through the monitoring of triggers (i.e., population growth, regulatory changes, and other policy decisions) as part of their implementation strategy. Similarly, the City of Los Angeles Department of Water and Power (LADPW) has an adopted Urban Water Management Plan (UWMP) that indicates that water supplies in the city will be sufficient to meet projected demands through 2035.⁵⁶ The proposed improvements would not increase existing passenger capacity at LAX. The proposed project would marginally increase long-term employment opportunities at Terminal 1. However, the potential increase in employment is not sufficient to result in any adverse impacts related to water demand or wastewater generation and would not require or result in the construction of new water or wastewater treatment facilities or expansion of existing facilities. The project would not result in an exceedance of wastewater treatment requirements of the LARWQCB. Moreover, no impact to water or wastewater facilities would occur with implementation of the proposed project, and no mitigation is required.

- c. Require or result in the construction of new stormwater drainage facilities or expansion of existing facilities, the construction of which could cause significant environmental effects?**

No Impact. The proposed project would not increase the amount of impermeable surface areas on the project site, or affect drainage patterns or stormwater drainage systems. Therefore, no impacts on stormwater drainage facilities would occur with the implementation of the proposed project, and no mitigation is required.

- d. Have sufficient water supplies available to serve the project from existing entitlements and resource, or are new or expanded entitlements needed?**

No Impact. As noted in Response XV11.a-b above, LADWP is the water purveyor for the project site. LADWP is responsible for supplying, treating, and distributing water within the City. According to LADWP, it has met the immediate needs of its customers and is well positioned to continue to do so in the future.⁵⁷ As discussed in Response XVII.a-b above, the proposed project would marginally increase employment but would not increase the passenger capacity at LAX or otherwise affect water demand. As such, no new or expanded water supply entitlements would be required. In addition, at a minimum, the proposed project would be designed to meet the requirements of CALGreen Tier 1, which would result in a reduction in potable water consumption by 30 percent through the installation of water-conserving fixtures and sub-metering of individual tenant spaces.

⁵⁷ City of Los Angeles, Department of Water and Power, Urban Water Management Plan, July 2010.

⁵⁷ City of Los Angeles, Department of Water and Power, Urban Water Management Plan, July 2010.

Therefore, no impacts on the City's water supply would occur with implementation of the proposed project, and no mitigation is required.

e. Result in a determination by the wastewater treatment provider which serves or may serve the project that it has adequate capacity to serve the project's projected demand in addition to the provider's existing commitments?

No Impact. As discussed in Response XVII.a-b above, the proposed project would marginally increase employment but would not increase passenger capacity at LAX or otherwise affect wastewater generation. Therefore, no impacts to wastewater treatment capacity would occur with the implementation of the proposed project, and no mitigation is required.

f. Be served by a landfill with sufficient permitted capacity to accommodate the project's solid waste disposal needs?

g. Comply with federal, state, and local statutes and regulations related to solid waste?

f-g. Less Than Significant Impact. Construction of the proposed project would result in demolition of the existing concrete pavement on the project site, which would generate approximately 25,900 cubic yards of materials that would need to be exported from the site. In addition, interior renovations would generate additional construction debris. During construction, a minimum of 65 percent of all construction debris would be recycled. Construction debris that cannot be recycled would be disposed of at facility permitted to accept inert solid waste (e.g., concrete and asphalt from construction and demolition activities). The total remaining permitted inert⁵⁸ (or unclassified landfill) waste capacity in Los Angeles County was estimated to be approximately 60.2 million tons in 2010. Based on the average countywide 2010 disposal rate of 400 tons per day (tpd), this capacity would be exhausted in 412 years.⁵⁹ Therefore, there is no anticipated shortfall in disposal capacity for inert waste within Los Angeles County.

As indicated in Section 5.0, Project Description, the proposed project has been designed to incorporate recycled building materials to the maximum extent possible, but in all cases, the minimum recycled content for the project would be 10 percent of total material costs. In addition, the project would be designed to provide space to support a recycling program for the tenant airlines and concessionaires, including area for depositing, storing, and collecting materials for recycling. It is anticipated solid waste generated within Terminal 1 that cannot be recycled would be taken to the Sunshine Canyon Landfill. The Sunshine Canyon Landfill is a Class III landfill located at 14747 San Fernando Road in Sylmar, California, approximately 82 miles from the project site. Sunshine Canyon Landfill is owned and operated by BFI, and has a maximum permitted throughput of 12,100 tons per day, with 5,500 tons per day allotted for City use and 6,600 for County use.⁶⁰ As of July 31, 2007, this facility had a remaining capacity of 112,300,000 cubic yards, and currently has an estimated closure

⁵⁸ Inert waste is waste that does not undergo any significant physical, chemical, or biological transformations. Examples of inert waste include construction and demolition debris.

⁵⁹ County of Los Angeles, Department of Public Works, 2010 Annual Report on the Countywide Summary Plan and Countywide Siting Element, October 2011.

⁶⁰ Sunshine Canyon Landfill website, Challenges, 2010, Available: http://www.sunshinelandfill.com/home/Future_Challenges.html, accessed: January 20, 2014.

date of 2037.⁶¹ The waste types accepted at this facility include construction and demolition debris, green materials, industrial, inert, and mixed municipal.

The solid waste generated from construction of the proposed project would be negligible when compared to the total solid waste disposed of on a daily and annual basis and the current capacity available at the Sunshine Landfill. Operation of the proposed project would marginally increase employment but would not increase passenger capacity at LAX or otherwise affect solid waste generation. As noted above, the proposed project would be served by a landfill with sufficient permitted capacity to accommodate the project's solid waste disposal needs and would comply with federal, state, and local statutes and regulations related to solid waste. Moreover, the proposed project would incorporate recycled building materials into construction and a portion of the construction debris would be recycled. As such, impacts related to solid waste disposal would be less than significant with the implementation of the proposed project, and no mitigation is required.

XVIII. MANDATORY FINDINGS OF SIGNIFICANCE.

- a. Does the project have the potential to degrade the quality of the environment, substantially reduce the habitat of fish or wildlife species, cause a fish or wildlife population to drop below self-sustaining levels, threaten to eliminate a plant or animal community, reduce the number or restrict the range of a rare or endangered plant or animal or eliminate important examples of the major periods of California history or prehistory?**

Less Than Significant Impact. The proposed project is located on a disturbed site within a developed airport. There are no plants or animal species listed on any state or federal lists of endangered, threatened or special status species or riparian/wetland areas, trees, or wildlife movement corridors at the project site or within any of the potential construction staging areas. Therefore, the proposed project would not have an impact on biological resources, and no mitigation is required.

There are no known cultural resources located on-site and the proposed project is located on a previously developed, highly disturbed site. Further, the project would not involve extensive excavation and thus would not result in destruction of archaeological or paleontological resources, or eliminate important examples of the major periods of California history or prehistory. As described in Response V.a, although the project is located in proximity to the Theme Building and Setting, no impacts to this historic resource would occur. Similarly, the potential use of Parking Structure F for construction staging and parking would not have any impacts on the Intermediate Terminal Complex. Therefore, impacts to cultural resources would be less than significant, and no mitigation is required.

- b. Does the project have impacts which are individually limited, but cumulatively considerable? ("Cumulatively considerable" means that the incremental effects of a project are considerable when viewed in connection with the effects of past projects, the effects of other current projects, and the effects of probable future projects).**

Less Than Significant Impact. The environmental analysis in the sections above indicates that the proposed project would have no impact on agricultural and forest resources, biological resources, cultural resources, land use and planning, mineral resources, population and housing, and recreation. In

⁶¹ California Integrated Waste Management Board (CIWMB)/CalRecycle, Solid Waste Information System, Facility/Site Summary Details: Sunshine Canyon City/County Landfill (19-AA-2000), Available: <http://www.calrecycle.ca.gov/SWFacilities/Directory/19-AA-2000/Detail/>, accessed: January 20, 2014.

addition, the analysis above found that implementation of the proposed project would have less than significant impact on aesthetics, air quality, geology and soils, greenhouse gas emissions, hazards and hazardous materials, hydrology and water quality, noise, public services, transportation/circulation, and utilities. By its very nature, climate change is a cumulative phenomenon and is not possible to link a single project to specific climatological changes; therefore the GHG emission analysis completed in Response VII, Greenhouse Gas Emissions, is a cumulative analysis.

To evaluate the proposed project's contribution to cumulative impacts, a list of applicable past, approved, and pending projects (known as "related projects") in the project vicinity were identified. These projects are listed in Table 10.

Figure 12 illustrates the location of the above projects in relationship to the project site. LAX Master Plan Alternative D/SPAS Development and Miscellaneous Projects and Improvements (such as ongoing maintenance activities/improvements within the CTA) are not on the figure because they occur at multiple locations throughout the airport.

The operation of the proposed project consists of renovation and modernization of Terminal 1. The proposed project would not expand or increase passenger or aircraft use of the facility, nor would project operations result in any significant impacts. The proposed project would improve the efficient operation of Terminal 1 and would enhance passenger convenience. Moreover, the proposed changes to curbside operations would result in a beneficial impact to traffic flow within the CTA. Operation of the project would not contribute to any cumulatively considerable impacts.

It is anticipated (based on current project schedules) that construction of many of the related projects would be expected to overlap with construction of the proposed project, which is estimated to begin in the third quarter of 2014 and is expected to take approximately 42 months to complete, ending in the fourth quarter of 2017. Potential cumulative impacts could occur during construction due to the proximity of the related projects to the project site and overlap in the construction periods; therefore, the proposed project could contribute to cumulative impacts during construction. However, based on the nature and location of the proposed project and the limited construction-related impacts (as detailed in each resource analysis above, construction-related impacts associated with the proposed project would be less than significant), the proposed project's contribution to construction-related cumulative impacts would not be cumulatively considerable.⁶² Therefore, the impact is less than significant and no mitigation is required.

c. Does the project have environmental effects which would cause substantial adverse effects on human beings, either directly or indirectly?

Less Than Significant Impact. Based on the analysis above, implementation of the proposed project would not have any environmental effects which could cause substantial adverse effects on human beings, either directly or indirectly. Therefore, the impact is less than significant, and no mitigation is required.

⁶² South Coast Air Quality Management District, White Paper on Potential Control Strategies to Address Cumulative Impacts from Air Pollution, August 2003.

Table 10
Related Projects

Figure 12 ID#	Project Name	Estimated Construction Timeframe	
		Start of Construction	Completion/ Implementation
1	Runway 7L/25R Runway Safety Area (RSA) Improvements (South Airfield)	Mar. 2014	Feb. 2015
2	Runway 6L/24R RSA Improvements (North Airfield) ^a	June 2014	June 2019
3	Bradley West Project (Remaining Work)	Nov. 2013	Dec. 2017
4	Terminal 3 Connector	July 2019	Jan. 2022
5	North Terminal Improvements	Aug. 2013	Aug. 2017
6	South Terminal Improvements	Nov. 2011	Feb. 2018
7	Midfield Satellite Concourse: Phase 1 - North Concourse Project	July 2014	July 2019
8	Central Utility Plant Replacement Project (Remaining Work)	Sep. 2013	Dec. 2014
9	Miscellaneous Projects and Improvements ^b	Jan. 2014	July 2020
10	LAX Northside Area Development ^a	Jan. 2016	Dec. 2022
11	LAX Master Plan Alt. D/Specific Plan Amendment Study (SPAS) Development ^{a,b,c}	June 2015	June 2025
12	Metro Crenshaw/LAX Transit Corridor and Station ^d	Dec. 2015	Apr. 2019
13	West Aircraft Maintenance Area Project	July 2014	Dec. 2016

Notes:

^a This project is subject to additional environmental review pursuant to the National Environmental Policy Act.

^b These improvements and projects would occur in various places on the landside and airside portions of LAX.

^c LAWA evaluated nine development alternatives for the LAX SPAS and, in May 2013, the Los Angeles City Council approved one alternative for advancement into further planning and evaluation; however, all the approvals necessary to implement that alternative have not yet occurred. For the purposes of the Terminal 1 Modernization Project cumulative construction impacts analysis, it is assumed that the LAX Master Plan improvements, as previously approved, will be implemented, which provides a more conservative analysis than if one were to assume the selected SPAS alternative, as more development would occur under the LAX Master Plan scenario than under the selected SPAS alternative.

^d Assumes only the portion of the overall Metro Crenshaw/LAX Transit Corridor and Station project that occurs in the general vicinity of LAX. Estimated schedule based on information obtained from Crenshaw/LAX Transit Corridor Project EIR, project website, and communications between LAWA staff and Metro staff.

Sources: LAWA 2013; CDM Smith 2013; Los Angeles County Metropolitan Transportation Authority (Metro), Crenshaw/LAX Transit Project, Available: http://www.metro.net/projects/crenshaw_corridor/, accessed: January 30, 2014.



Note: Development projects on Table 10 not shown on map (i.e., 9 and 11) occur at multiple locations within airport.

- | | | |
|---|--|--|
| 1 Runway 7L/25R RSA Improvements (South Airfield) | 4 Terminal 3 (T-3) Connector | 8 Central Utility Plant Replacement Project |
| 2 Runway 6L/24R RSA Improvements (North Airfield) | 5 North Terminal Improvements | 10 LAX Northside Area Development |
| 3 Bradley West Project | 6 South Terminal Improvements | 12 Metro Crenshaw/LAX Transit Corridor and Station |
| | 7 Midfield Satellite Concourse Phase 1 - North Project | 13 West Aircraft Maintenance Area Project |



Source: Los Angeles World Airports, 2014; CDM Smith, 2014.
Prepared by: CDM Smith, 2014.

LAX Terminal 1 Modernization Project

Development Projects At/Adjacent to LAX

This page intentionally left blank.

REFERENCES

- California Air Resources Board, Area Designations Maps/State and National Homepage, Available: <http://www.arb.ca.gov/desig/adm/adm.htm>, accessed May 28, 2013.
- California Climate Action Registry, General Reporting Protocol, Version 3.1, January 2009.
- California Department of Transportation, California Scenic Highway Mapping System website, Available: http://www.dot.ca.gov/hq/LandArch/scenic_highways/index.htm, accessed August 14, 2013.
- California Emissions Estimator Model (CalEEMod) Homepage, developed by ENVIRON International Corporation in collaboration with SCAQMD and other California Air Districts, Available: <http://www.caleemod.com/>, accessed May 28, 2013, August 29, 2013.
- California Integrated Waste Management Board (CIWMB)/CalRecycle, Solid Waste Information System, Facility/Site Summary Details: Sunshine Canyon City/County Landfill (19-AA-2000), Available: <http://www.calrecycle.ca.gov/SWFacilities/Directory/19-AA-2000/Detail/>, accessed January 20, 2014.
- California Water Resources Control Board, GeoTracker, Allied Signal (Park One) – L.A. (SL184101393), Geo_Well 1st SA 2012 Data, Available: http://geotracker.waterboards.ca.gov/profile_report.asp?cmd=viewgeo&sub_type=GEO_WELL&global_id=SL184101393&conf_num=7900756776, accessed January 28, 2014.
- City of Los Angeles, Final Environmental Impact Report for Los Angeles International Airport (LAX) Proposed Master Plan Improvements, April 2004.
- City of Los Angeles, Draft Environmental Impact Report for Los Angeles International Airport (LAX) Specific Plan Amendment Study Project, Section 4.5 and Appendix E-1, July 2012.
- City of Los Angeles, L.A. CEQA Thresholds Guide, Your Resource for Planning CEQA Analysis in Los Angeles, 2006.
- City of Los Angeles, Passenger Traffic Comparison by Terminal, Los Angeles International Airport, December 2012 (year to date information), Available: <http://www.lawa.org/laxstatistics.aspx>, accessed March 8, 2013.
- City of Los Angeles, LAX Plan, September 29, 2004, as amended.
- City of Los Angeles, Los Angeles International Airport Specific Plan, September 29, 2004, as amended.
- City of Los Angeles, Department of City Planning, Air Quality Element: An Element of the General Plan of the City of Los Angeles, November 1992.
- City of Los Angeles, Department of City Planning, Safety Element of the City of Los Angeles General Plan, Exhibit C, Landslide Inventory & Hillside Areas in the City of Los Angeles, June 1994.
- City of Los Angeles, Department of City Planning, Safety Element of the City of Los Angeles General Plan, Exhibit D, Selected Wildfire Hazard Areas in the City of Los Angeles, April 1996.
- City of Los Angeles, Department of City Planning, Safety Element of the City of Los Angeles General Plan, Exhibit E, Oil Field & Oil Drilling Areas in the City of Los Angeles, May 1994.

City of Los Angeles, Department of City Planning, Safety Element of the City of Los Angeles General Plan, Exhibit G, Inundation & Tsunami Hazard Areas in the City of Los Angeles, March 1994.

County of Los Angeles, Department of Public Works, 2010 Annual Report on the Countywide Summary Plan and Countywide Siting Element, October 2011.

City of Los Angeles, Department of Transportation, Traffic Study Policies and Procedures, revised August 2011.

City of Los Angeles, Department of Transportation, Traffic Counts Conducted by LADOT's Traffic Survey Section, 10-Year Summary 2001-2010, Available at:
<http://ladot.lacity.org/WhatWeDo/TrafficVolumeCounts/CurrentCountData/index.htm>, accessed on February 4, 2014.

City of Los Angeles, Department of Water and Power, Urban Water Management Plan, July 2010.

City of Los Angeles, Los Angeles World Airports, Passenger Traffic Comparison by Terminal, Los Angeles International Airport, Available: <http://lawa.org/uploadedfiles/LAX/statistics/ptcom-1213.pdf>, accessed February 3, 2014.

City of Los Angeles, Los Angeles World Airports, Statistics – Ten Year Summary – Passengers, Available: http://lawa.org/welcome_LAX.aspx?id=800, accessed February 13, 2014.

City of Los Angeles, Los Angeles World Airports, LAWA Noise Management, California State Airport Noise Standards Quarterly Report, Second Quarter 2013, Available:
<http://www.lawa.org/uploadedFiles/LAX/pdf/2Q13%20QuarterlyReport%20map.pdf>, accessed February 4, 2014.

Environmental Data Resources Inc. (EDR), EDR Data Map Area Study, Los Angeles, California, August 2011.

Los Angeles County Metropolitan Transportation Authority (Metro), Crenshaw/LAX Transit Project, Available: http://www.metro.net/projects/crenshaw_corridor/, accessed: January 30, 2014.

South Coast Air Quality Management District, White Paper on Potential Control Strategies to Address Cumulative Impacts from Air Pollution, August 2003.

South Coast Air Quality Management District, Final 2007 Air Quality Management Plan, June 2007.

South Coast Air Quality Management District, Final 2012 Air Quality Management Plan, December 2012.

South Coast Air Quality Management District, Final Localized Significance Threshold Methodology, July 2008.

South Coast Air Quality Management District, Draft Guidance Document – Interim CEQA Greenhouse Gas (GHG) Significance Threshold, October 2008.

South Coast Air Quality Management District, SCAQMD Air Quality Significance Thresholds, March 2011.

Sunshine Canyon Landfill website, Challenges, 2010, Available:
http://www.sunshinecanyonlandfill.com/home/Future_Challenges.html, accessed: January 20, 2014.

The Boeing Company, The Role of Computer Simulation in Reducing Airplane Turn Time, Available: http://www.boeing.com/commercial/aeromagazine/aero_01/textonly/t01txt.html, accessed February 1, 2014.

This page intentionally left blank.

PREPARERS AND PERSONS CONTACTED

Lead Agency

City of Los Angeles
Los Angeles World Airports
Capital Programming & Planning Division
One World Way, Room 218
Los Angeles, California 90045

Christopher Koontz, Project Manager

Initial Study Preparation

CDM Smith Inc.
111 Academy, Suite 150
Irvine, California 92617

Robin Ijams, Project Manager
Kathleen Owston, Senior Planner
Drew Poulter, Planner
Asami Tanimoto, Air Quality Specialist
Gwen Pelletier, Air Quality Technical Review

Project Applicant

Southwest Airlines
2702 Love Field Drive
Dallas, Texas 75235

Don Ostler, Senior Project Manager
Steve Hubbell, Properties Manager

Project Facilitation

AvAirPros
300 N. Continental Boulevard, Suite 625
El Segundo, California 90245

Matt Ross, Program Director
Scott Biddinger, Program Manager

Osborne Design Management Company
7249 Franklin Avenue, Suite 104
Los Angeles, California 90046

Todd Osborne, AIA, Design Manager

Project Architect

PGAL

5933 West Century Blvd., Suite 1050

Los Angeles, California 90045

Jeff Gerber, CEO

Kenneth Brown, President

Diana Payne, Project Architect

APPENDIX A

Air Quality Calculations

This page intentionally left blank.

**LAX Terminal 1 Modernization Program
Emissions Summary**

Daily Emissions (50% MY2007 Haul Trucks)

	Daily Emissions (lb/day)					
	VOC	NOx	CO	SOx	PM10	PM2.5
Offroad Exhaust	6.0	58.9	57.3	0.1	3.8	3.5
Onroad Exhaust	2.6	32.2	56.9	0.2	5.0	1.8
Fugitive Dust						
Loading/Unloading	--	--	--	--	2.1	0.3
Grading	--	--	--	--	0.2	0.0
Fugitive VOC						
Paving	28.1	--	--	--	--	--
Coating	1.7	--	--	--	--	--
TOTAL	38	91	114	0	11	6
SCAQMD Threshold	75	100	550	150	150	55
Onsite Total	36	59	57	0	6	4
LST	N/A	201	5,533	N/A	109	55

2014 Emissions (50% MY2007 Haul Trucks)

	Annual Emissions (tons per year)						(metric tons per year)			(metric tons CO2e per year)			
	VOC	NOx	CO	SOx	PM10	PM2.5	CO2	CH4	N2O	CO2	CH4	N2O	Total
Offroad Exhaust	0.4	3.7	3.6	0.0	0.2	0.2	421.5	0.0	0.0	421.5	1.0	0.4	422.9
Onroad Exhaust	0.2	1.8	3.6	0.0	0.3	0.1	972.0	0.0	0.0	972.0	0.7	7.5	980.2
Fugitive Dust													
Loading/Unloading	--	--	--	--	0.0	0.0	--	--	--	--	--	--	--
Grading	--	--	--	--	0.0	0.0	--	--	--	--	--	--	--
Fugitive VOC													
Paving	0.2	--	--	--	--	--	--	--	--	--	--	--	--
Coating	0.1	--	--	--	--	--	--	--	--	--	--	--	--
TOTAL	0.8	5.5	7.2	0.0	0.6	0.3	1,393.5	0.1	0.0	1,393.5	1.7	7.9	1,403.1

2015 Emissions (50% MY2007 Haul Trucks)

	Annual Emissions (tons per year)						(metric tons per year)			(metric tons CO2e per year)			
	VOC	NOx	CO	SOx	PM10	PM2.5	CO2	CH4	N2O	CO2	CH4	N2O	Total
Offroad Exhaust	0.6	5.7	5.8	0.0	0.4	0.3	635.8	0.1	0.0	635.8	1.5	0.8	638.1
Onroad Exhaust	0.3	3.1	7.1	0.0	0.6	0.2	1,809.6	0.1	0.0	1,809.6	1.4	13.7	1,824.7
Fugitive Dust													
Loading/Unloading	--	--	--	--	0.0	0.0	--	--	--	--	--	--	--
Grading	--	--	--	--	0.0	0.0	--	--	--	--	--	--	--
Fugitive VOC													
Paving	0.2	--	--	--	--	--	--	--	--	--	--	--	--
Coating	0.2	--	--	--	--	--	--	--	--	--	--	--	--
TOTAL	1.3	8.8	12.9	0.0	1.0	0.5	2,445.4	0.1	0.0	2,445.4	3.0	14.4	2,462.9

2016 Emissions (50% MY2007 Haul Trucks)

	Annual Emissions (tons per year)						(metric tons per year)			(metric tons CO2e per year)			
	VOC	NOx	CO	SOx	PM10	PM2.5	CO2	CH4	N2O	CO2	CH4	N2O	Total
Offroad Exhaust	0.6	5.4	5.4	0.0	0.4	0.3	606.4	0.1	0.0	606.4	1.5	0.7	608.6
Onroad Exhaust	0.3	3.1	7.1	0.0	0.6	0.2	1,816.3	0.1	0.0	1,816.3	1.5	13.7	1,831.5
Fugitive Dust													
Loading/Unloading	--	--	--	--	0.0	0.0	--	--	--	--	--	--	--
Grading	--	--	--	--	0.0	0.0	--	--	--	--	--	--	--
Fugitive VOC													
Paving	0.2	--	--	--	--	--	--	--	--	--	--	--	--
Coating	0.2	--	--	--	--	--	--	--	--	--	--	--	--
TOTAL	1.3	8.5	12.6	0.0	1.0	0.5	2,422.7	0.1	0.0	2,422.7	2.9	14.4	2,440.1

2017 Emissions (50% MY2007 Haul Trucks)

	Annual Emissions (tons per year)						(metric tons per year)			(metric tons CO2e per year)			
	VOC	NOx	CO	SOx	PM10	PM2.5	CO2	CH4	N2O	CO2	CH4	N2O	Total
Offroad Exhaust	0.4	3.7	3.6	0.0	0.2	0.2	414.2	0.0	0.0	414.2	1.0	0.4	415.5
Onroad Exhaust	0.2	2.2	5.3	0.0	0.5	0.2	1,337.1	0.1	0.0	1,337.1	1.1	10.0	1,348.2
Fugitive Dust													
Loading/Unloading	--	--	--	--	0.0	0.0	--	--	--	--	--	--	--
Grading	--	--	--	--	0.0	0.0	--	--	--	--	--	--	--
Fugitive VOC													
Paving	0.1	--	--	--	--	--	--	--	--	--	--	--	--
Coating	0.2	--	--	--	--	--	--	--	--	--	--	--	--
TOTAL	0.9	5.9	8.9	0.0	0.7	0.4	1,751.2	0.1	0.0	1,751.2	2.1	10.4	1,763.7

Annual Emissions (50% MY2007 Haul Trucks)

	Annual Emissions (tons per year)						(metric tons per year)			(metric tons CO2e per year)			
	VOC	NOx	CO	SOx	PM10	PM2.5	CO2	CH4	N2O	CO2	CH4	N2O	Total
2014	0.8	5.5	7.2	0.0	0.6	0.3	1,394	0.1	0.0	1,394	1.7	7.9	1,403
2015	1.3	8.8	12.9	0.0	1.0	0.5	2,445	0.1	0.0	2,445	3.0	14.4	2,463
2016	1.3	8.5	12.6	0.0	1.0	0.5	2,423	0.1	0.0	2,423	2.9	14.4	2,440
2017	0.9	5.9	8.9	0.0	0.7	0.4	1,751	0.1	0.0	1,751	2.1	10.4	1,764

**LAX Terminal 1 Modernization Program
Off-Road Vehicle Emissions**

Emission Factors

Equipment Type	Emission Factors (lb/hr)						(g/hr)			Equipment hp
	VOC	NOx	CO	SOx	PM10	PM2.5	CO2	CH4	N2O	
Back-Hoe	0.038	0.440	0.283	0.000	0.035	0.032	18,949	2.1	0 0	97
Boom Lift	0.027	0.183	0.124	0.000	0.014	0.013	8,914	1.1	0 0	62
Concrete Pump	0.074	0.511	0.346	0.001	0.040	0.037	24,728	3.0	0 0	84
Crane	0.078	1.128	0.255	0.001	0.052	0.048	45,949	3.6	0 0	226
Drill Rig	0.041	0.800	0.281	0.002	0.024	0.022	69,901	2.5	0 0	205
Excavator	0.044	0.635	0.616	0.001	0.031	0.029	47,079	4.3	0 0	162
Excavator/Breaker	0.044	0.635	0.616	0.001	0.031	0.029	47,079	4.3	0 0	162
Forklift	0.029	0.191	0.160	0.000	0.015	0.014	10,495	1.2	0 0	89
Loader	0.038	0.440	0.283	0.000	0.035	0.032	18,949	2.1	0 0	97
Misc (Diesel)	0.123	0.665	0.481	0.001	0.046	0.042	34,453	5.0	0 0	156
Misc (Propane)	0.004	0.150	1.211	0.000	0.003	0.003	14,389	13.4	0 0	106
Misc (Gasoline)	0.257	0.149	7.344	0.000	0.040	0.037	8,549	6.6	6 5	47
Skid Steer	0.013	0.209	0.145	0.000	0.012	0.011	10,335	0.8	0 0	64
Sweeper	0.044	0.446	0.272	0.000	0.039	0.036	18,137	2.2	0 0	64

2014 off-road vehicle model/database default emission factors used. Equipment hp based on default CalEEMod equipment size.

Miscellaneous diesel-powered equipment is an average of all industrial, commercial, and portable diesel-powered equipment in OFFROAD2007.

Miscellaneous propane-powered equipment is an average of all industrial, commercial, and portable diesel-powered equipment in OFFROAD2007.

Miscellaneous gasoline-powered equipment is an average of all industrial, commercial, and construction gasoline-powered equipment in OFFROAD2007.

Equipment Hours

	Excavator	Excavator/ Breaker	Crane	Forklift	Concrete Pump	Loader	Back-Hoe	Drill Rig	Concrete Trucks	Dump Trucks	Skid Steer	Sweeper	Boom Lift	Misc (Diesel)	Misc (Propane)	Misc (Gasoline)
Maximum Daily	17	16	4	38	4	12	17	5	4	7	16	20	13	7	3	2
Annual																
2014	2,138	1,973	534	4,769	514	1,480	2,138	576	514	863	1,973	2,467	1,645	822	411	247
2015	2,960	2,631	1,069	8,880	740	1,973	2,960	822	740	1,151	2,631	3,289	3,618	1,562	781	469
2016	2,796	2,631	904	8,223	740	1,973	2,796	740	740	1,151	2,631	3,618	3,289	1,398	699	419
2017	1,973	1,973	534	4,769	469	1,480	1,973	493	469	863	1,973	2,796	1,973	822	411	247

Usage factor 0.83

Daily Emissions

	Daily Emissions (lb/day)					
	VOC	NOx	CO	SOx	PM10	PM2.5
Excavator	0.62	8.98	8.71	0.02	0.44	0.41
Excavator/Breaker	0.57	8.29	8.04	0.02	0.41	0.37
Crane	0.28	3.99	0.90	0.00	0.18	0.17
Forklift	0.92	6.03	5.05	0.01	0.48	0.45
Concrete Pump	0.25	1.74	1.18	0.00	0.14	0.12
Loader	0.37	4.31	2.77	0.00	0.34	0.31
Back-Hoe	0.54	6.22	4.00	0.01	0.49	0.45
Drill Rig	0.16	3.05	1.07	0.01	0.09	0.08
Skid Steer	0.17	2.72	1.90	0.00	0.16	0.15
Misc (Diesel)	0.67	3.62	2.62	0.01	0.25	0.23
Misc (Propane)	0.01	0.41	3.29	0.00	0.01	0.01
Misc (Gasoline)	0.42	0.24	11.98	0.00	0.07	0.06
Sweeper	0.72	7.27	4.44	0.01	0.64	0.59
Boom Lift	0.29	2.00	1.35	0.00	0.15	0.14
Total	5.98	58.85	57.28	0.08	3.85	3.54

Annual Emissions - 2014

	Annual Emissions (tons/year)						(metric tons per year)			(metric tons CO2e per year)			Total
	VOC	NOx	CO	SOx	PM10	PM2.5	CO2	CH4	N2O	CO2	CH4	N2O	
Excavator	0.04	0.57	0.55	0.00	0.03	0.03	84	0.01	0.00	84	0.2	0.0	84
Excavator/Breaker	0.04	0.52	0.51	0.00	0.03	0.02	77	0.01	0.00	77	0.1	0.0	78
Crane	0.02	0.25	0.06	0.00	0.01	0.01	20	0.00	0.00	20	0.0	0.0	20
Forklift	0.06	0.38	0.32	0.00	0.03	0.03	42	0.00	0.00	42	0.1	0.0	42
Concrete Pump	0.02	0.11	0.07	0.00	0.01	0.01	11	0.00	0.00	11	0.0	0.0	11
Loader	0.02	0.27	0.17	0.00	0.02	0.02	23	0.00	0.00	23	0.1	0.0	23
Back-Hoe	0.03	0.39	0.25	0.00	0.03	0.03	34	0.00	0.00	34	0.1	0.0	34
Drill Rig	0.01	0.19	0.07	0.00	0.01	0.01	34	0.00	0.00	34	0.0	0.0	34
Skid Steer	0.01	0.17	0.12	0.00	0.01	0.01	17	0.00	0.00	17	0.0	0.0	17
Misc (Diesel)	0.04	0.23	0.16	0.00	0.02	0.01	24	0.00	0.00	24	0.1	0.0	24
Misc (Propane)	0.00	0.03	0.21	0.00	0.00	0.00	5	0.00	0.00	5	0.1	0.0	5
Misc (Gasoline)	0.03	0.02	0.75	0.00	0.00	0.00	2	0.00	0.00	2	0.0	0.4	2
Sweeper	0.05	0.46	0.28	0.00	0.04	0.04	37	0.00	0.00	37	0.1	0.0	37
Boom Lift	0.02	0.13	0.09	0.00	0.01	0.01	12	0.00	0.00	12	0.0	0.0	12
Total	0.38	3.71	3.61	0.01	0.24	0.22	422	0.05	0.00	422	0.98	0.41	423

Annual Emissions - 2015

	Annual Emissions (tons/year)						(metric tons per year)			(metric tons CO2e per year)			Total
	VOC	NOx	CO	SOx	PM10	PM2.5	CO2	CH4	N2O	CO2	CH4	N2O	
Excavator	0.05	0.78	0.76	0.00	0.04	0.04	116	0.01	0.00	116	0.2	0.0	116
Excavator/Breaker	0.05	0.70	0.68	0.00	0.03	0.03	103	0.01	0.00	103	0.2	0.0	103
Crane	0.03	0.50	0.11	0.00	0.02	0.02	41	0.00	0.00	41	0.1	0.0	41
Forklift	0.11	0.71	0.59	0.00	0.06	0.05	78	0.01	0.00	78	0.2	0.0	78
Concrete Pump	0.02	0.16	0.11	0.00	0.01	0.01	15	0.00	0.00	15	0.0	0.0	15
Loader	0.03	0.36	0.23	0.00	0.03	0.03	31	0.00	0.00	31	0.1	0.0	31
Back-Hoe	0.05	0.54	0.35	0.00	0.04	0.04	47	0.01	0.00	47	0.1	0.0	47
Drill Rig	0.01	0.27	0.10	0.00	0.01	0.01	48	0.00	0.00	48	0.0	0.0	48
Skid Steer	0.01	0.23	0.16	0.00	0.01	0.01	23	0.00	0.00	23	0.0	0.0	23
Misc (Diesel)	0.08	0.43	0.31	0.00	0.03	0.03	45	0.01	0.00	45	0.1	0.0	45
Misc (Propane)	0.00	0.05	0.39	0.00	0.00	0.00	9	0.01	0.00	9	0.2	0.0	10
Misc (Gasoline)	0.05	0.03	1.43	0.00	0.01	0.01	3	0.00	0.00	3	0.1	0.8	4
Sweeper	0.06	0.61	0.37	0.00	0.05	0.05	50	0.01	0.00	50	0.1	0.0	50
Boom Lift	0.04	0.28	0.19	0.00	0.02	0.02	27	0.00	0.00	27	0.1	0.0	27
Total	0.61	5.65	5.78	0.01	0.37	0.34	636	0.07	0.00	636	1.53	0.79	638

Annual Emissions - 2016

	Annual Emissions (tons/year)						(metric tons per year)			(metric tons CO2e per year)			Total
	VOC	NOx	CO	SOx	PM10	PM2.5	CO2	CH4	N2O	CO2	CH4	N2O	
Excavator	0.05	0.74	0.72	0.00	0.04	0.03	110	0.01	0.00	110	0.2	0.0	110
Excavator/Breaker	0.05	0.70	0.68	0.00	0.03	0.03	103	0.01	0.00	103	0.2	0.0	103
Crane	0.03	0.43	0.10	0.00	0.02	0.02	35	0.00	0.00	35	0.1	0.0	35
Forklift	0.10	0.65	0.55	0.00	0.05	0.05	72	0.01	0.00	72	0.2	0.0	72
Concrete Pump	0.02	0.16	0.11	0.00	0.01	0.01	15	0.00	0.00	15	0.0	0.0	15
Loader	0.03	0.36	0.23	0.00	0.03	0.03	31	0.00	0.00	31	0.1	0.0	31
Back-Hoe	0.04	0.51	0.33	0.00	0.04	0.04	44	0.00	0.00	44	0.1	0.0	44
Drill Rig	0.01	0.25	0.09	0.00	0.01	0.01	43	0.00	0.00	43	0.0	0.0	43
Skid Steer	0.01	0.23	0.16	0.00	0.01	0.01	23	0.00	0.00	23	0.0	0.0	23
Misc (Diesel)	0.07	0.39	0.28	0.00	0.03	0.02	40	0.01	0.00	40	0.1	0.0	40
Misc (Propane)	0.00	0.04	0.35	0.00	0.00	0.00	8	0.01	0.00	8	0.2	0.0	9
Misc (Gasoline)	0.04	0.03	1.28	0.00	0.01	0.01	3	0.00	0.00	3	0.0	0.7	4
Sweeper	0.07	0.67	0.41	0.00	0.06	0.05	55	0.01	0.00	55	0.1	0.0	55
Boom Lift	0.04	0.25	0.17	0.00	0.02	0.02	24	0.00	0.00	24	0.1	0.0	24
Total	0.57	5.40	5.45	0.01	0.36	0.33	606	0.07	0.00	606	1.45	0.70	609

Annual Emissions - 2017

	Annual Emissions (tons/year)						(metric tons per year)			(metric tons CO2e per year)			Total
	VOC	NOx	CO	SOx	PM10	PM2.5	CO2	CH4	N2O	CO2	CH4	N2O	
Excavator	0.04	0.52	0.51	0.00	0.03	0.02	77	0.01	0.00	77	0.1	0.0	78
Excavator/Breaker	0.04	0.52	0.51	0.00	0.03	0.02	77	0.01	0.00	77	0.1	0.0	78
Crane	0.02	0.25	0.06	0.00	0.01	0.01	20	0.00	0.00	20	0.0	0.0	20
Forklift	0.06	0.38	0.32	0.00	0.03	0.03	42	0.00	0.00	42	0.1	0.0	42
Concrete Pump	0.01	0.10	0.07	0.00	0.01	0.01	10	0.00	0.00	10	0.0	0.0	10
Loader	0.02	0.27	0.17	0.00	0.02	0.02	23	0.00	0.00	23	0.1	0.0	23
Back-Hoe	0.03	0.36	0.23	0.00	0.03	0.03	31	0.00	0.00	31	0.1	0.0	31
Drill Rig	0.01	0.16	0.06	0.00	0.00	0.00	29	0.00	0.00	29	0.0	0.0	29
Skid Steer	0.01	0.17	0.12	0.00	0.01	0.01	17	0.00	0.00	17	0.0	0.0	17
Misc (Diesel)	0.04	0.23	0.16	0.00	0.02	0.01	24	0.00	0.00	24	0.1	0.0	24
Misc (Propane)	0.00	0.03	0.21	0.00	0.00	0.00	5	0.00	0.00	5	0.1	0.0	5
Misc (Gasoline)	0.03	0.02	0.75	0.00	0.00	0.00	2	0.00	0.00	2	0.0	0.4	2
Sweeper	0.05	0.52	0.32	0.00	0.05	0.04	42	0.01	0.00	42	0.1	0.0	42
Boom Lift	0.02	0.15	0.10	0.00	0.01	0.01	15	0.00	0.00	15	0.0	0.0	15
Total	0.38	3.68	3.59	0.01	0.24	0.22	414	0.05	0.00	414	0.97	0.41	416

Unit Conversion

2000 pounds per ton
 453.592 g/lb
 1,000,000 g/metric tons

GWP	1	21	310
------------	---	----	-----

**LAX Terminal 1 Modernization Program
On-Road Vehicle Emissions - 50% MY 2007 Haul Trucks**

Emission Factors

Vehicle Type	Emission Factors (g/mi)								
	VOC	NOx	CO	SOx	PM10	PM2.5	CO2	CH4	N2O
Construction worker vehicles	0.057	0.178	1.814	0.004	0.139	0.043	365.6	0.020	0.007
Haul trucks	0.323	11.173	1.515	0.017	0.402	0.254	1,721.4	0.015	0.057
Haul trucks (MY2007)	0.263	6.523	1.293	0.017	0.255	0.120	1,752.3	0.012	0.057

Notes:

Emission factors for construction worker vehicles are for gasoline and diesel LDA, LDT1, and LDT2 vehicles in Los Angeles County for Year 2014, obtained via the web-based EMFAC database.

Emission factors for haul trucks are for diesel T7 single unit construction vehicles in Los Angeles County for Year 2014, obtained via the web-based EMFAC database.

It was assumed that N2O emissions for gasoline vehicles are 4.16% of NOx emissions. N2O emissions for diesel vehicles are 0.3316 g/gal fuel. (EMFAC2011 FAQ)

Fuel economy for haul trucks were assumed to be 5.8 mpg. (TRC General Reporting Protocol)

Methane emissions for haul trucks were assumed to be 4.08% of TOG emissions. (EMFAC2011 FAQ)

PM emissions include exhaust, tire wear, brake wear, and fugitive dust from paved roads.

Number of Vehicle Trips

	Daily	2014	2015	2016	2017
Construction worker vehicles	658	82,908	165,158	165,816	125,020
Haul trucks (onsite only)	10	1,486	1,486	1,486	744
Haul trucks (offsite)	58	8,758	14,496	14,542	10,210

Vehicle Miles Traveled

	Per Trip	Max Daily	2014	2015	2016	2017
Construction worker vehicles	20	13,160	1,658,160	3,303,160	3,316,320	2,500,400
Haul trucks (onsite only)	2	20	2,972	2,972	2,972	1,488
Haul trucks (offsite)	23.5	1,363	205,813	340,656	341,737	239,935
Haul trucks total		1,383	208,785	343,628	344,709	241,423

Daily Emissions 50% MY2007 Haul Trucks

Vehicle Type	Daily Emissions (lb/day)					
	VOC	NOx	CO	SOx	PM10	PM2.5
Construction worker vehicles	1.662	5.175	52.630	0.118	4.045	1.255
Haul trucks	0.893	26.978	4.281	0.051	1.002	0.570
Total	2.555	32.153	56.911	0.169	5.047	1.825

Annual Emissions

Vehicle Type	Annual Emissions (tpy)						(metric tons per year)			(metric tons CO2e per year)			
	VOC	NOx	CO	SOx	PM10	PM2.5	CO2	CH4	N2O	CO2	CH4	N2O	Total
2014													
Construction worker vehicles	0.105	0.326	3.316	0.007	0.255	0.079	606.2	0.03	0.01	606.2	0.7	3.8	610.6
Haul trucks	0.060	1.501	0.298	0.004	0.059	0.028	365.9	0.00	0.01	365.9	0.1	3.7	369.6
2014 Total	0.165	1.827	3.613	0.011	0.314	0.107	972.0	0.04	0.02	972.0	0.74	7.50	980.2
2015													
Construction worker vehicles	0.209	0.649	6.605	0.015	0.508	0.157	1,207.5	0.06	0.02	1,207.5	1.4	7.6	1,216.4
Haul trucks	0.100	2.471	0.490	0.006	0.097	0.045	602.1	0.00	0.02	602.1	0.1	6.1	608.3
2015 Total	0.308	3.120	7.095	0.021	0.604	0.203	1,809.6	0.07	0.04	1,809.6	1.45	13.66	1,824.7
2016													
Construction worker vehicles	0.209	0.652	6.631	0.015	0.510	0.158	1,212.3	0.06	0.02	1,212.3	1.4	7.6	1,221.3
Haul trucks	0.100	2.479	0.491	0.006	0.097	0.046	604.0	0.00	0.02	604.0	0.1	6.1	610.2
2016 Total	0.309	3.131	7.123	0.021	0.607	0.204	1,816.3	0.07	0.04	1,816.3	1.45	13.71	1,831.5
2017													
Construction worker vehicles	0.158	0.492	5.000	0.011	0.384	0.119	914.0	0.05	0.02	914.0	1.0	5.7	920.8
Haul trucks	0.070	1.736	0.344	0.005	0.068	0.032	423.0	0.00	0.01	423.0	0.1	4.3	427.4
2017 Total	0.228	2.228	5.344	0.016	0.452	0.151	1,337.1	0.05	0.03	1,337.1	1.09	10.01	1,348.2

Unit Conversion

2,000 lb/ton
 453.592 g/lb
 1,000,000 g/metric tons

GWP	1	21	310
------------	---	----	-----

This page intentionally left blank.

LAX Terminal 1 Modernization Program

Truck Loading/Unloading Fugitive Dust Emissions

Drop Operation Dust Equation (AP-42 Section 13.2.4)

$$E = k (0.0032) \left[\frac{\left(\frac{U}{5}\right)^{1.3}}{\left(\frac{M}{2}\right)^{1.4}} \right]$$

where: E = emission factor (lb/ton)
 k = 0.35 for PM10
 = 0.053 for PM2.5
 U = mean wind speed (mph)
 M = material moisture content (%)

Assumptions

Mean wind speed 7.5 mph (Los Angeles AP, National Climatic Data Center)
 Moisture content 2.4 % (AP-42 Table 11.9-3 haul truck moisture content)
 Number of drops 2

Emission Factors

PM10 (lb/ton)	PM2.5 (lb/ton)
0.001	0.0002

lb/ton = pounds per ton of material

Loading/Unloading Emissions

	Materials Handled (cy)	(ton)	PM10 (lb/day)	PM2.5 (lb/day)
Daily	1,110	1403.2	2.063	0.312

Loading/Unloading Emissions

Year	Materials Handled (cy)	(ton)	PM10 (tpy)	PM2.5 (tpy)
2014	14,800	18,710	0.014	0.002
2015	14,800	18,710	0.014	0.002
2016	14,800	18,710	0.014	0.002
2017	7,400	9,355	0.007	0.001

cy = cubic yards

tpy = tons per year

Conversion factors

1.26 ton soil/cubic yard (CalEEMod Default)
 2,000 pound/ton

Sources:

- National Oceanic and Atmospheric Administration (NOAA). 2011. National Climatic Data Center Comparative Climatic Data - Average Wind Speed. Accessed on December 19, 2013. Available at <http://ols.nndc.noaa.gov/plolstore/plsql/olstore.prodspecific?prodnum=C00095-PUB-A0001#TABLES>
 - South Coast Air Quality Management District. 2013 California Emissions Estimator Model User's Guide Version 2013.2. July.
 - USEPA. 2006. Compilation of Air Pollutant Emission Factors (AP-42). Fifth Edition, Volume I. Chapter 13.2.4 Aggregate Handling and Storage Piles. November.

LAX Terminal 1 Modernization Program

Grading Fugitive Dust Emissions

Grading Dust Equation (AP-42 Table 11.9-1)

$$PM_{10} = 0.60 \times 0.051 (S)^2$$

$$PM_{2.5} = 0.031 \times 0.040 (S)^{2.5}$$

where: S = mean vehicle speed (mph).

Assumptions

$$S = 7.1 \text{ mph} \quad (\text{AP-42 Table 11.9-3})$$

Emission Factors

PM10 (lb/VMT)	PM2.5 (lb/VMT)
1.543	0.167

lb/VMT = pounds per vehicle mile traveled

Construction Data

Time Period	Disturbed Area (sq ft)	Distance traveled (mi)
Max Daily	19,800	0.31
Annual 2014	264,000	4.17
2015	264,000	4.17
2016	264,000	4.17
2017	132,000	2.08

Number of passes 2
 Blade width 12 feet (CalEEMod Default)
 Dust suppression 55% reduced by water application

Daily Grading Emissions

Year	PM10 (lb/day)	PM2.5 (lb/day)
Uncontrolled	0.482	0.052
Controlled	0.217	0.023

Annual Grading Emissions

Year	PM10 (tpy)	PM2.5 (tpy)
Uncontrolled		
2014	0.003	0.000
2015	0.003	0.000
2016	0.003	0.000
2017	0.002	0.000
Controlled		
2014	0.001	0.000
2015	0.001	0.000
2016	0.001	0.000
2017	0.001	0.000

tpy = tons per year

Conversion factors

43,560 square feet/acre
 5,280 feet/mile
 2,000 pound/ton

Sources:

- South Coast Air Quality Management District. 2013 California Emissions Estimator Model User's Guide Version 2013.2. July.
- USEPA. 1998 Compilation of Air Pollutant Emission Factors (AP-42). Fifth Edition, Volume I. Chapter 11.9 Western Surface Coal Mining. July.

LAX Terminal 1 Modernization Program

Paving Emissions

Paving Emission Rate

2.62 pound VOC/acre (CalEEMod default)

Note: actual paving emission rate may be lower as blacktop asphalt will not be used.

Traffic Coating Emission Rate

100 grams VOC/liter SCAQMD Rule 1113 Traffic Coatings

180 square feet/gallon (CalEEMod default)

0.0046 pound VOC/square foot

Construction Data

Total Site Area	11 acre		
Daily Paving Rate	0.2 acre/day	Daily Painting Rate	5,940 sq ft/day
2014	3.0 acre/year		79,200 sq ft/year
2015	3.0 acre/year		79,200 sq ft/year
2016	3.0 acre/year		79,200 sq ft/year
2017	1.5 acre/year		39,600 sq ft/year

Daily Paving Emissions

	VOC (lb/day)
Daily	28.132

Annual Paving Emissions

Year	VOC (tpy)
2014	0.188
2015	0.188
2016	0.188
2017	0.094

tpy = tons per year

Conversion factor

2,000 pounds/ton
 453.592 grams/pound
 3.785 liter/gallon
 43,560 square feet/acre

Source: South Coast Air Quality Management District. 2013 California Emissions Estimator Model User's Guide Version 2013.2. July.

APPENDIX B

Traffic Impact Evaluation Report

This page intentionally left blank.

TECHNICAL MEMORANDUM

TO: Robin Ijams, CDM Smith
Christopher Koontz, LAWA

FROM: Srinath Raju, P.E.
Christopher Muñoz

SUBJECT: LAX Terminal 1 Modernization Project – Traffic Impact Evaluation

DATE: March 3, 2014

REF: RA 439

This technical memorandum documents a traffic impact evaluation of the LAX Terminal 1 Modernization Project conducted by Raju Associates, Inc. The traffic impact analysis included herein has been conducted in accordance with the policies and procedures contained in the current City of Los Angeles Department of Transportation's (LADOT) *Traffic Study Policies and Procedures*.

This technical memorandum summarizes the project description as it pertains to the ground transportation system, existing and future peak hour traffic volumes with and without the Proposed Project at key intersections within the Central Terminal Area (CTA) on both the upper (departure) and lower (arrival) levels, and evaluates the existing and future level of service (LOS) and the traffic effects of the Proposed Project at these key CTA intersections.

PROJECT DESCRIPTION

The Proposed Project consisting of reconstruction and modernization of Terminal 1 would result in modification to the existing 306,256 square-foot Terminal 1 by increasing the building square-footage by approximately 59,150 square feet. The proposed reconstruction would address deficiencies and provide improvements that would extend the life of the building and improve functionality of Terminal 1. The Project would improve passenger level of service following International Air Transport Association (IATA) 'C' standards; provide sufficient space of security screening checkpoint (SSCP) with enhanced queuing areas; provide checked baggage inspection

system (CBIS) facilities; move ticketing and curbside functions west (away from the Sky Way/World Way intersection); provide expanded and upgraded level of finish in the departure and arrival levels; accommodate expected migration by Southwest Airlines to larger fleet of Boeing 737-700w and 737-800w aircraft; improve energy efficiencies; optimize baggage and passenger processing functions; meet City of Los Angeles and State of California building codes; meet current Transportation Security Administration (TSA) requirements for security screening and provide flexible space for next generation passenger and baggage security screening functions.

Terminal 1 is located within the Los Angeles International Airport (LAX) and is illustrated in Figure 1. It is located on the north side of World Way North on the eastern end of the CTA. Terminal 1 currently operates 15 gates and serves Southwest Airlines and other airlines. US Airways that used to operate at Terminal 1 has moved its operations to Terminal 3 since mid-February of 2014. The gates formerly occupied by US Airways are currently being used by other airlines.

Southwest Airlines is responsible for implementation of the modernization program and upon successful completion of the program elements, the improvements will be acquired from the airline by the City of Los Angeles. The Project is expected to be completed by 2017.

As noted above, the modernization of Terminal 1 includes modification and enhancements to the location and functionality of some of the building's existing uses. These modifications are anticipated to improve the utilization of the departure (upper level) and arrival (lower level) curbs and roadways immediately adjacent to the terminal. The modifications to the existing uses, as they affect the ground transportation system, include the following:

- All Skycap functions will be relocated to a new area at the west end of the building (Terminal 1). Skycap functions will occur north of the existing sidewalk, clearing the sidewalk of pedestrian congestion and improving safety.
- All ticketing functions will be consolidated into the West Lobby causing the primary building entrance to be located in the western half of the building. A secondary entrance for passengers bypassing the ticket lobby is located at the center of the building. The East Lobby will be converted into a SSCP and the existing entrances to the East Lobby will be converted to "emergency exit only" from this side of the building. Vehicles dropping passengers at the curbside will be attracted westwards to these entrances thereby increasing the effective length of curbside in front of the Terminal 1 building and increasing the amount of stacking space for vehicular drop-off.

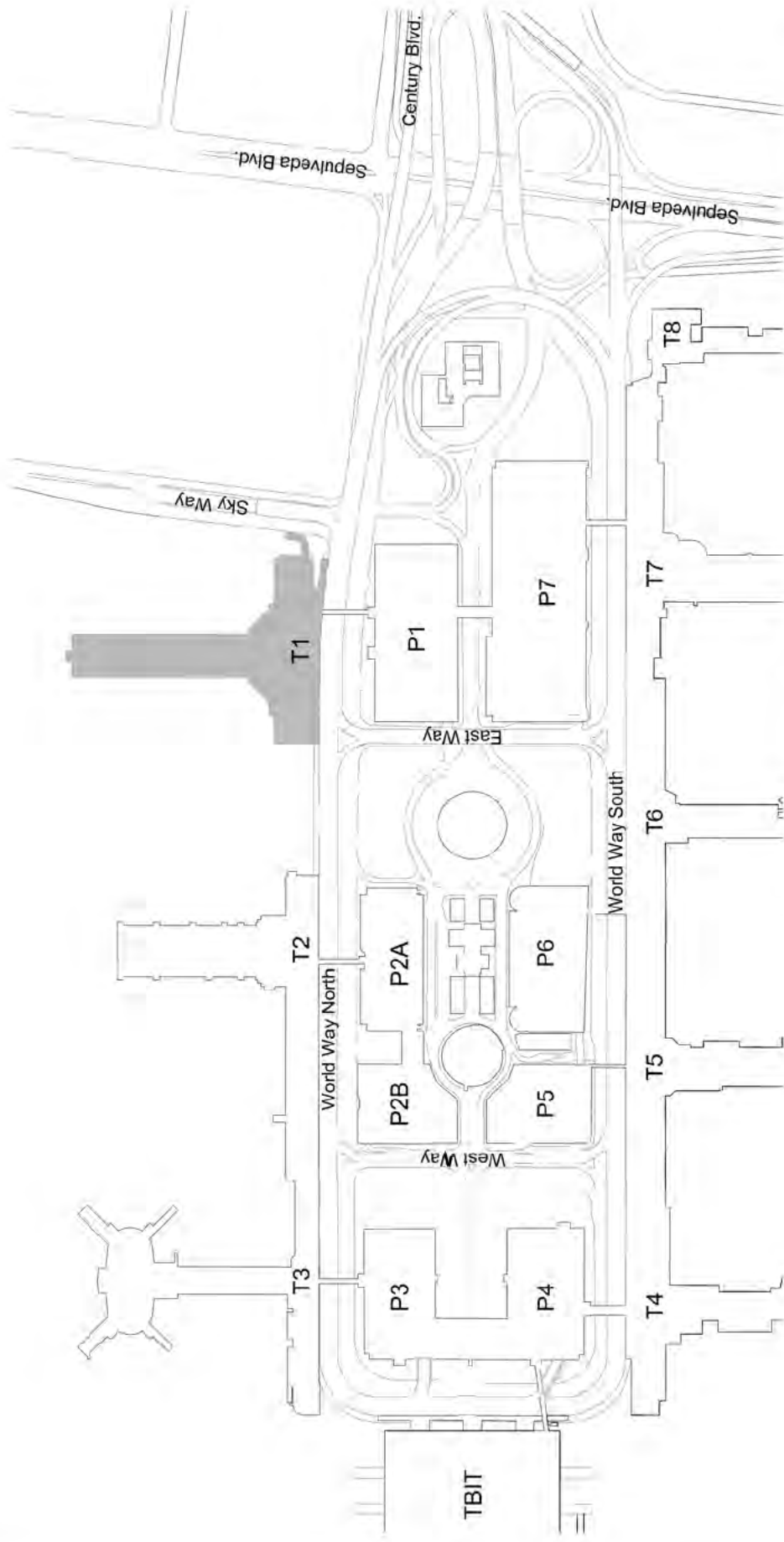

LAX CENTRAL TERMINAL AREA

Source: LAWA, 2010; Ricondo & Associates, Inc., 2012

LEGEND:

-  Project Site

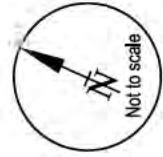

FIGURE 1
LOCATION OF PROPOSED PROJECT - LAX TERMINAL 1

- Within the terminal, the arrival level will be reconfigured to accommodate a new CBIS which will enhance the efficiency and capabilities of the TSA. The fully automated system will be located in the eastern half of the terminal below the new SSCP. All arriving passengers claiming checked bags will flow through doors located within the western half of the building then proceed through doors located within the west half and center of the building to access the curbside activities. Again, vehicles picking up passengers at the curbside will be attracted westward thereby increasing the effective length of curbside available in front of the Terminal 1 building, away from the intersection of Sky Way and World Way.

In summary, the Skycap and ticketing functions would be relocated to the west end of Terminal 1. Additionally, the new Checked Baggage Inspection System on the Arrival Level would only be accessible from the western half and center of the Terminal 1 Building. From a ground transportation perspective, these improvements would attract vehicles/passengers to locations further west and away from the intersection of Sky Way/World Way on both the upper and lower levels, reducing vehicle congestion and enhancing vehicular flow past Terminal 1 and through the CTA.

METHODOLOGY

The study is directed at the analysis of potential traffic effects/impacts on the street system within the CTA produced by the Proposed Project and includes an analysis of the following scenarios:

- Existing (Current) 2013 Conditions - The analysis of existing traffic conditions is intended to provide a basis for the remainder of the study. The existing conditions analysis includes an assessment of streets, traffic volumes, and operating conditions.
- Future (2017) without Project Conditions - Future traffic conditions in the year 2017 without the Proposed Project have been developed. The objective of this analysis is to project future traffic growth and operating conditions, which could be expected by the year 2017.
- Future (2017) with Project Conditions – The Proposed Project would not result in any growth in the future number of aircraft or passengers. Projected changes in aircraft activity and passenger levels would occur with or without the project. There would be a small increase in on-airport employees at Terminal 1 associated with new concessions, however, employees would park in employee parking lots outside of the CTA and would travel to the terminal on board existing shuttles. The additional employees would mostly arrive and depart outside the peak commute hours. Therefore, the net traffic occurring within the CTA under the Future (2017) with Project Conditions would be the same as that associated with the Future (2017) without Project Conditions. The focus of this analysis,

therefore, is on changes to CTA roadway operations that would result from modifications to the building layout and curbside functions. The net traffic expected to be shifted due to improvements by the Proposed Project is estimated and the Future (2017) with Project traffic forecasts are developed. The impacts of the Proposed Project on future traffic operating conditions are then identified.

For this traffic evaluation, seven key locations within the CTA were defined as study intersections. These locations are shown in Figure 2. Three intersections are located on the upper (departure) level and four intersections are located on the lower (arrival) level. All study intersections are controlled by traffic signals and include the following:

Upper Level Intersections

1. Sky Way and World Way North
2. West Way and World Way South
3. East Way and World Way South

Lower Level Intersections

4. Sky Way and World Way North
5. West Way and Center Way
6. East Way and Center Way
7. World Way South & Center Way

EXISTING CONDITIONS

A comprehensive data collection effort was undertaken to develop a detailed description of existing conditions within the study area (i.e. Central Terminal Area – upper and lower levels). The assessment of conditions relevant to this study includes description of the CTA street system, traffic volumes on these facilities, and operating conditions at key intersections. A detailed description of these elements is presented in this section.

Central Terminal Area (CTA) Roadway System and Access (Roadway Interface System)

The CTA roadway system consists of two-level loop roadways (upper and lower levels circulating in a counter-clockwise direction) with vehicular access to both the departure (upper) and arrival (lower) levels from Century Boulevard, Sepulveda Boulevard and 96th Street Bridge/Sky Way Drive. Figure 3 illustrates the CTA roadway system. The upper level roadway is dedicated to passenger departure activity, while the lower level roadway is dedicated to passenger arrival

UPPER LEVEL - DEPARTURE

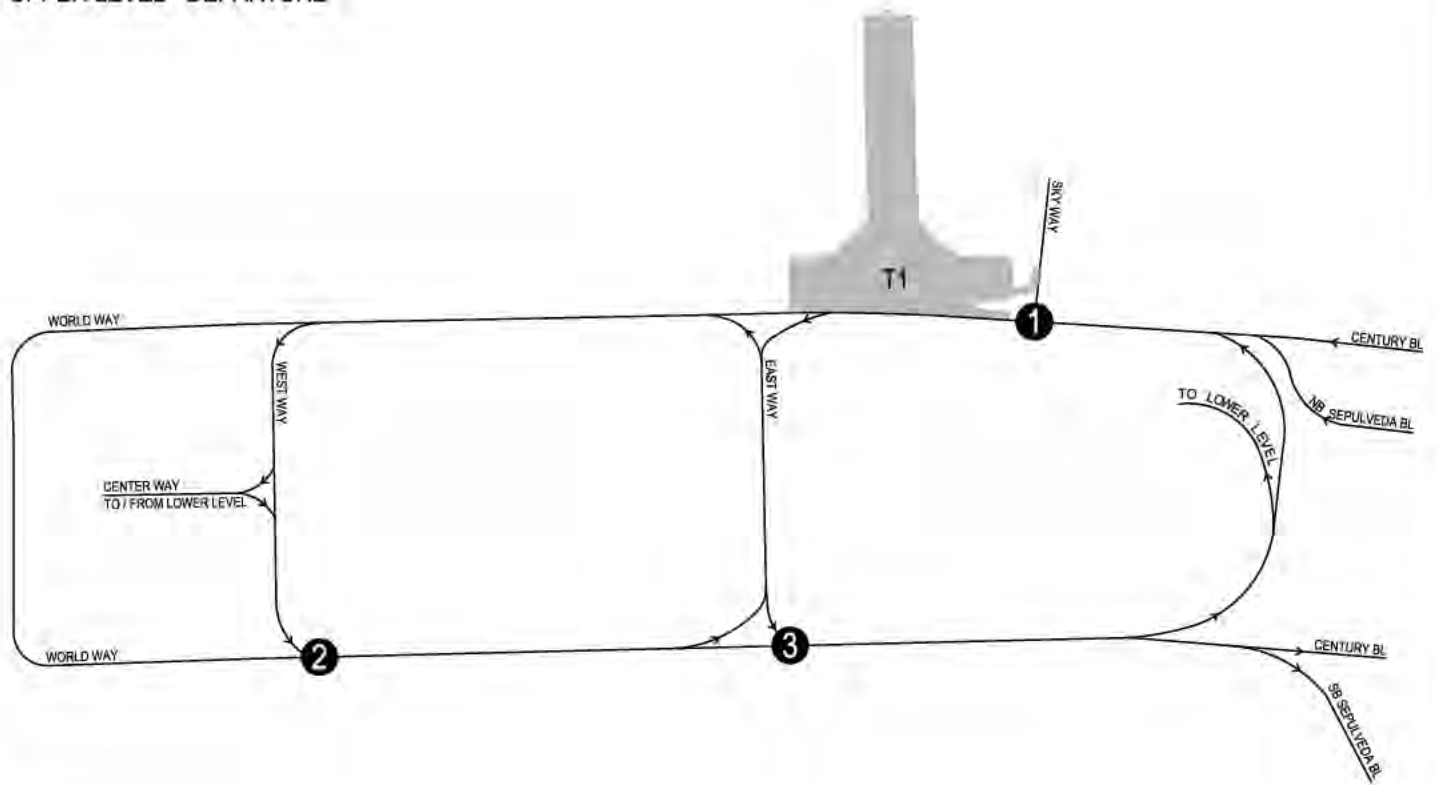

LOWER LEVEL - ARRIVAL

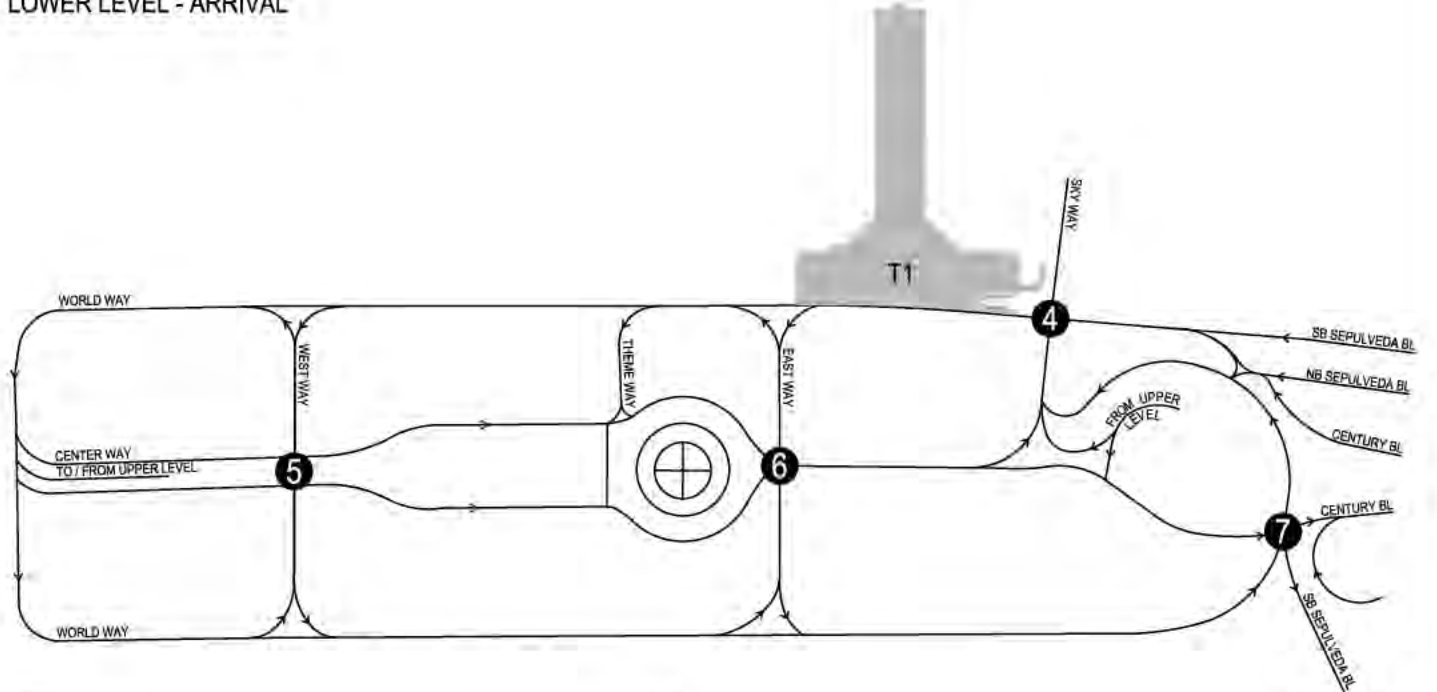

LEGEND :

- Study Intersection

█ - Project Site



FIGURE 2
LOCATION OF STUDY INTERSECTIONS

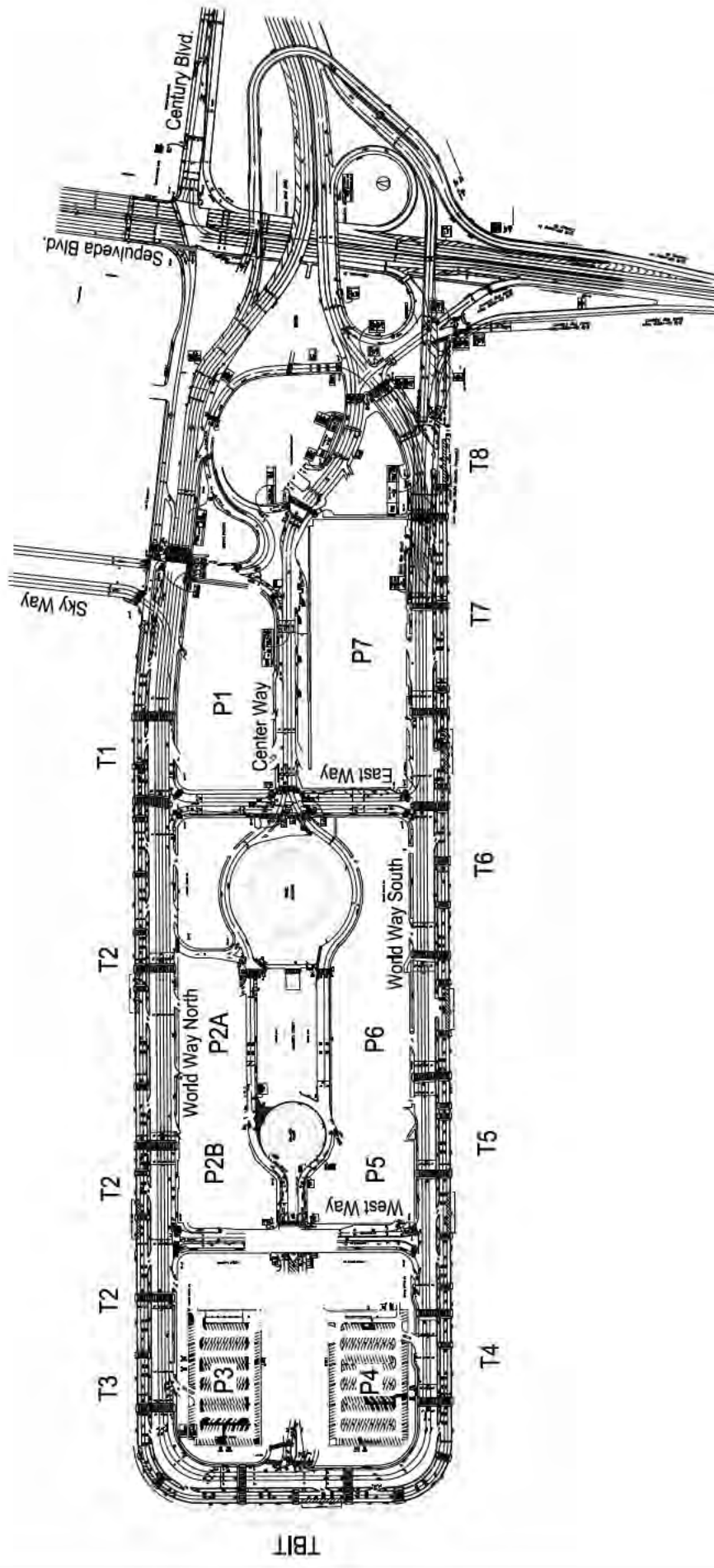

- Legend:**
- T# - Terminal Facility
 - P# - Parking Facility
 - TBIT - Tom Bradley International Terminal

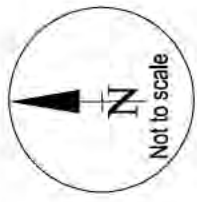

FIGURE 3
LAX CENTRAL TERMINAL AREA (CTA) ROADWAY SYSTEM & ITS VICINITY



activity. The CTA roadway network provides access to the CTA's parking garages which accommodate short-term and daily parking for passengers and visitors. A recirculation ramp located at the eastern end of the CTA (at Center Way and World Way South) and a ramp at the western end of Center Way, connecting to West Way provide on-airport circulation between the departure level and the arrival level. Center Way provides egress from the parking garages as well as from the loop roadway at the lower level to Century Boulevard and Sepulveda Boulevard. The CTA roadway system has a de-facto speed limit of 25 miles per hour.

The departure level roadway curbside consists generally of a 22-foot wide stopping lane for passenger drop-offs and pick-ups; and three 10 to 12-foot wide travel lanes for vehicles to circulate. Northbound Sepulveda Boulevard, southbound Sepulveda Boulevard, 96th Street, Century Boulevard and Sky Way provide direct inbound access to the departure level. Direct egress from the departure level to southbound Sepulveda Boulevard and eastbound Century Boulevard is available. Vehicles headed northbound on Sepulveda Boulevard must use the ramp to Center Way and exit the airport with the arrival level traffic at Center Way to access the northbound Sepulveda Boulevard clover-leaf ramp, south of Century Boulevard.

The arrival level is served by two curbsides (an inner and outer curbside) and the loop roadway system. The inner and outer curbsides are separated by a 10-foot wide pedestrian loading area. The inner curbside roadway generally consists of a 10-foot wide loading lane and two 10-foot wide circulating lanes. The outer roadway consists of a 20-foot wide lane adjacent to a commercial loading area and three to five additional travel lanes used for circulation. Northbound and southbound Sepulveda Boulevard, 96th Street and westbound Century Boulevard provide direct inbound access to the arrival level. Direct egress from the arrival level roadway system is available to northbound and southbound Sepulveda Boulevard and eastbound Century Boulevard.

The existing roadway lane configurations for the upper and lower level intersections are shown in Figures 4A and 4B, respectively.

Terminal 1 Curbside Conditions

Currently, on the upper level, the east half of the terminal is occupied by Southwest Airlines and approximately 85% of the terminal's passenger traffic passes through this portion of the building. These passengers have access to the Skycap located on the sidewalk in front of the eastern half of the building. The short segment of World Way (N) experiences a high volume of vehicles driving toward the curb immediately after passing through the intersection of Sky Way/World Way

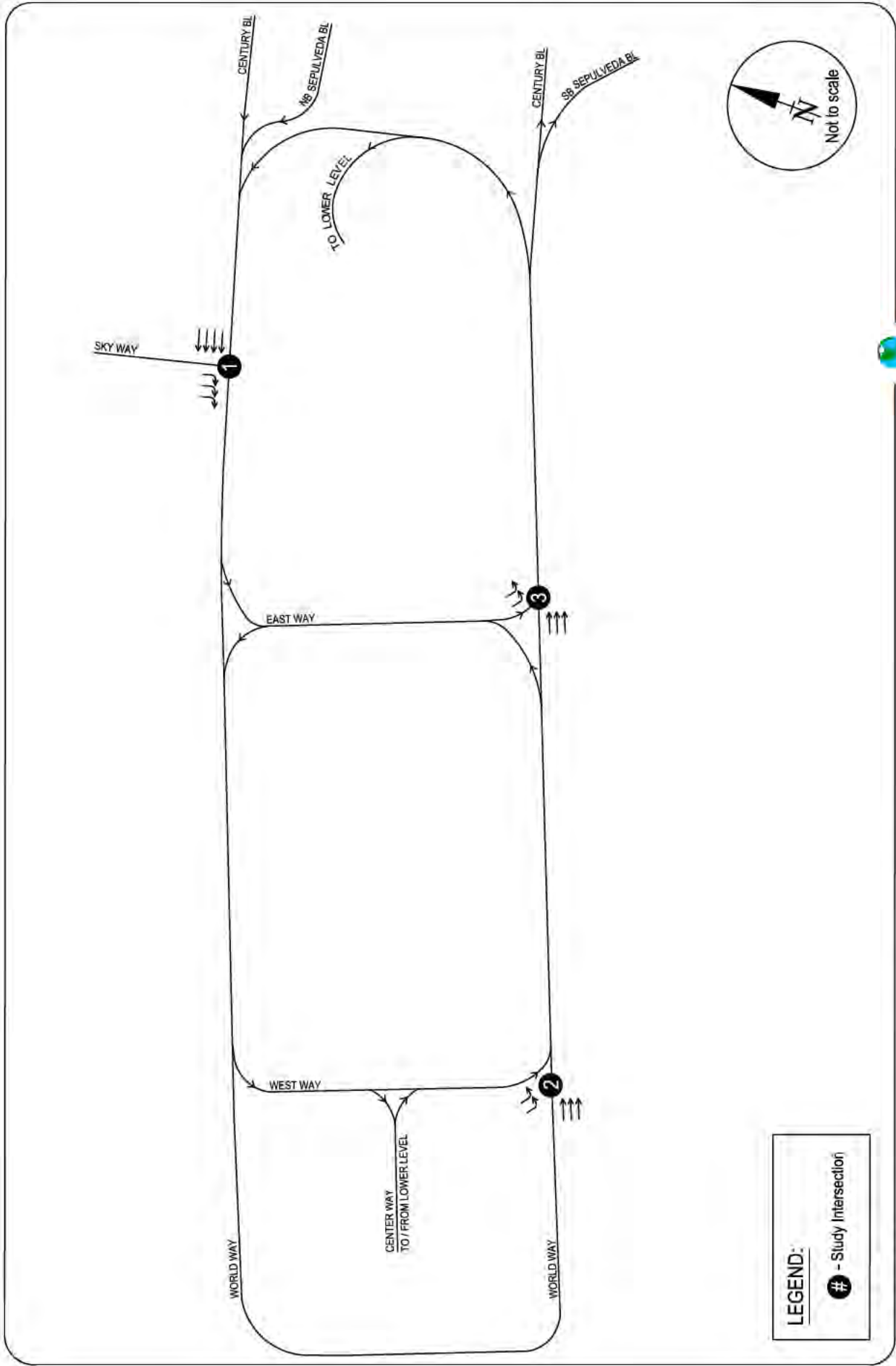

FIGURE 4A
EXISTING LANE CONFIGURATIONS - UPPER LEVEL



RAJU Associates, Inc.

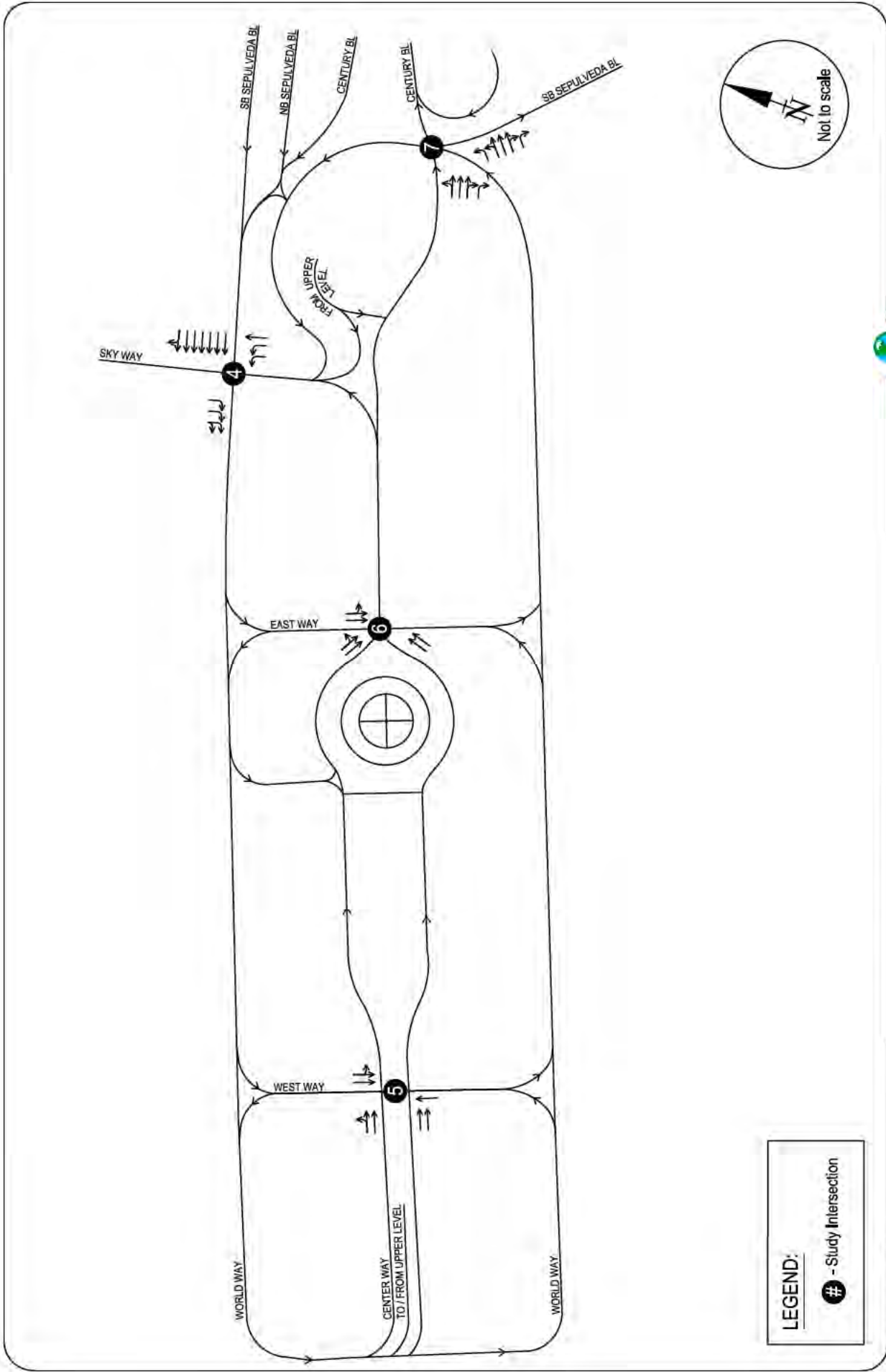

FIGURE 4B
EXISTING LANE CONFIGURATIONS - LOWER LEVEL



RAJU Associates, Inc.

traffic signal. With insufficient merge distance combined with a mix of commercial and private vehicles, vehicular congestion is observed which compromises safety and throughput rate.

On the lower level, a majority of passengers currently exit through the exit doors located in the easternmost half of the building which provides egress from the East Baggage Claim. From these doors, passengers access landside activities such as curbside passenger pick-up, taxis, shared-ride vans and car services located at the inner curb; and ground transportation commercial vehicles such as hotel, rental car, remote parking, employee, and inter-terminal shuttles, Flyaway and charter buses located along the outer curb. Some passengers use signalized crosswalks to access Parking Structure 1.

As noted earlier, the Arrival Level roadway is configured with an inner curb and outer curb roadway system that provide curb space to accommodate both the private and commercial ground transportation services. The close proximity of the exit and entry doors to Terminal 1 to the intersection of Sky Way/World Way creates merging activity amongst commercial and private vehicles similar to that noted on the upper level roadway resulting in vehicular congestion, compromised safety and reduced throughput rate.

Existing Weekday Traffic Volumes

Weekday morning (7-9 AM), midday (MD) (11 AM–1PM) and evening (4-6 PM) peak hour traffic counts were compiled from data collected at the seven analyzed intersections during August 2013. These weekday traffic volumes reflect peak weekday operations during current year 2013 conditions. The traffic volumes in Figures 5A and 5B for the upper level and Figures 6A and 6B for the lower level represent, for the purposes of this analysis, the Existing 2013 peak hour conditions. The raw data showing the counts are provided in Attachment A.

Level of Service Methodology

Level of service (LOS) is a qualitative measure used to describe the condition of traffic flow, ranging from excellent conditions at LOS A to overloaded conditions at LOS F. LOS D is typically recognized as the minimum acceptable level of service in urban areas. The definitions for level of service of signalized intersections are provided in Table 1. All of the study intersections are controlled by traffic signals.

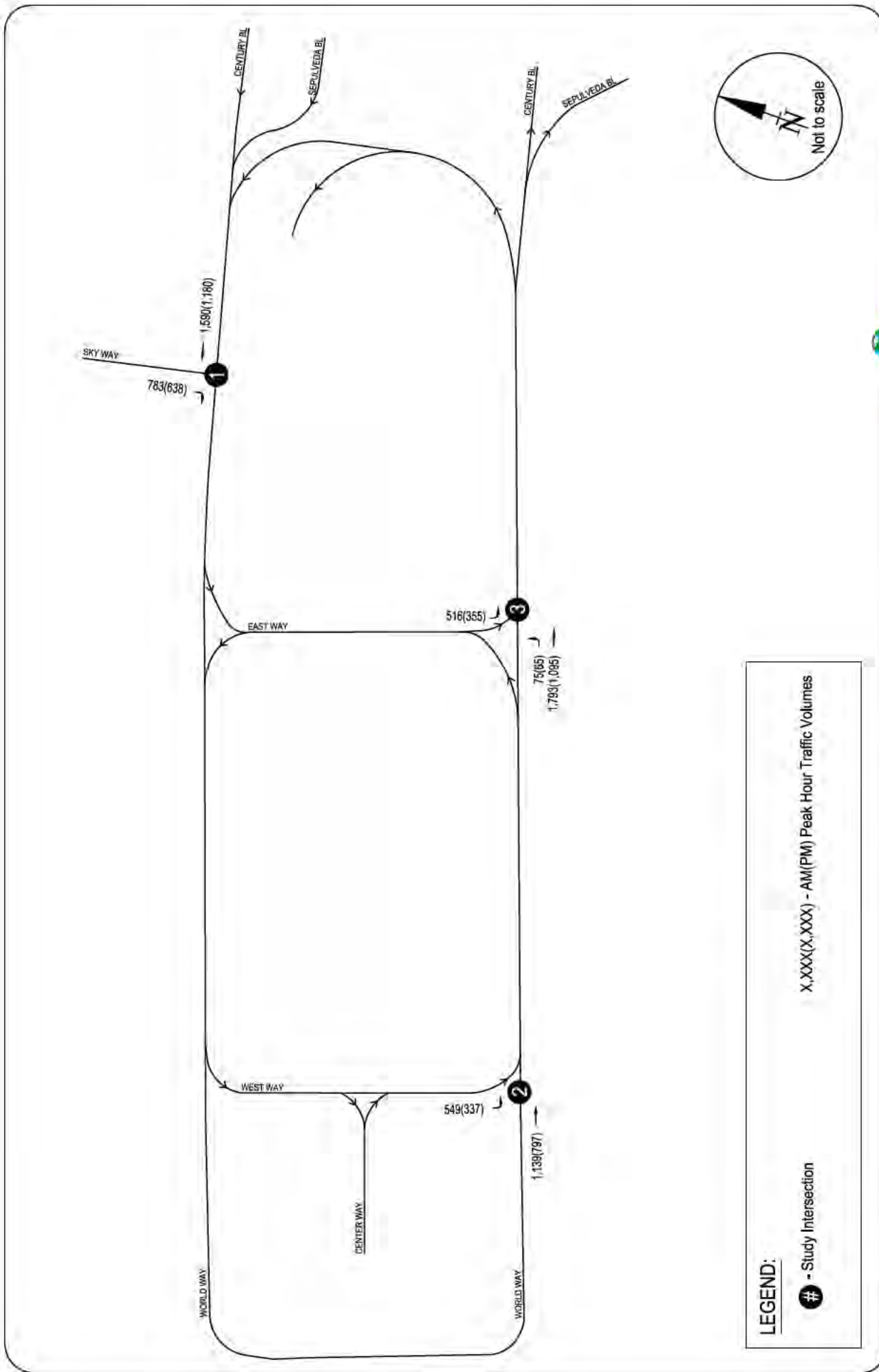

FIGURE 5A
EXISTING (2013) AM / PM PEAK HOUR TRAFFIC VOLUMES - UPPER LEVEL

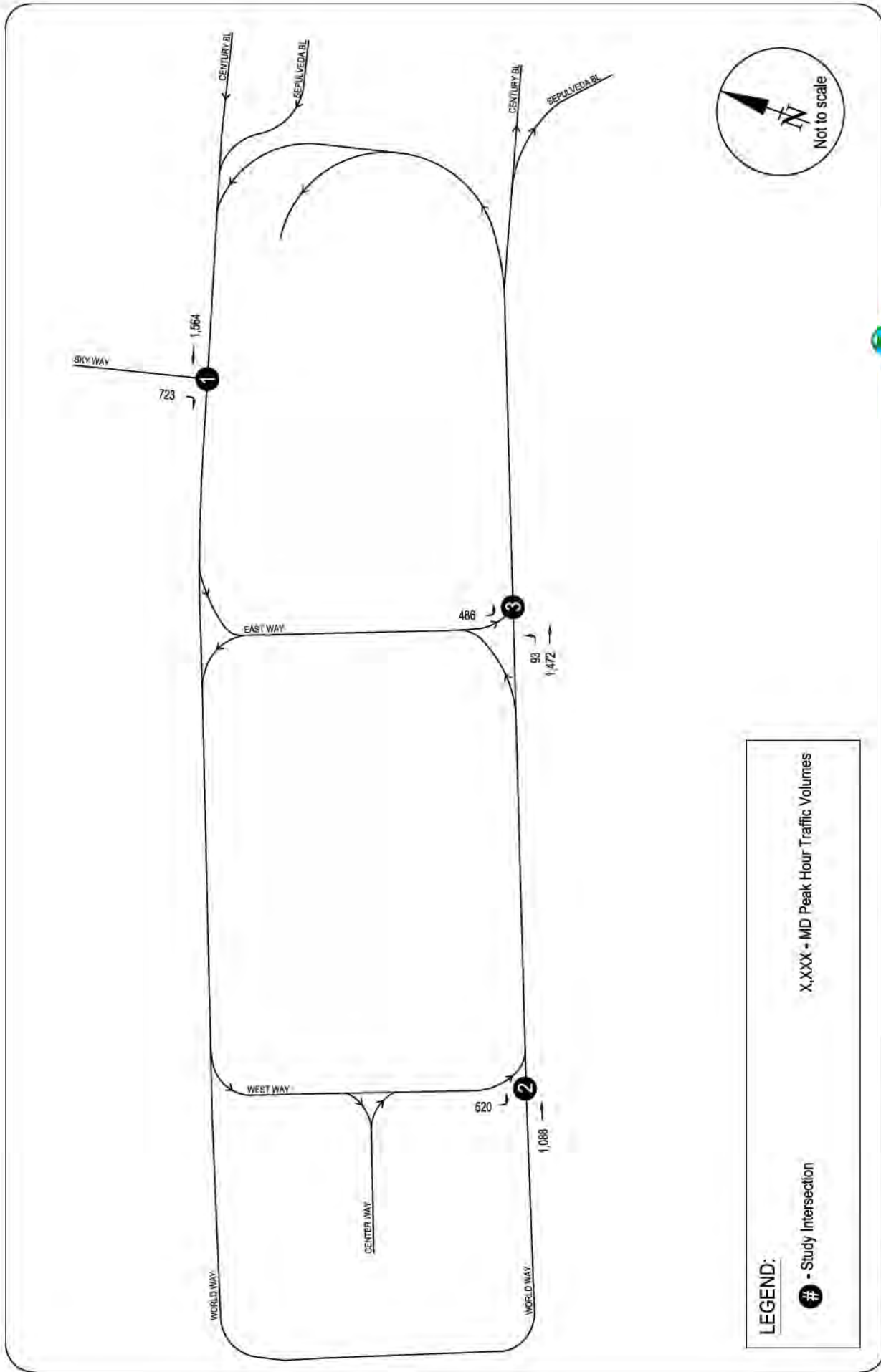

FIGURE 5B
EXISTING (2013) MD PEAK HOUR TRAFFIC VOLUMES - UPPER LEVEL

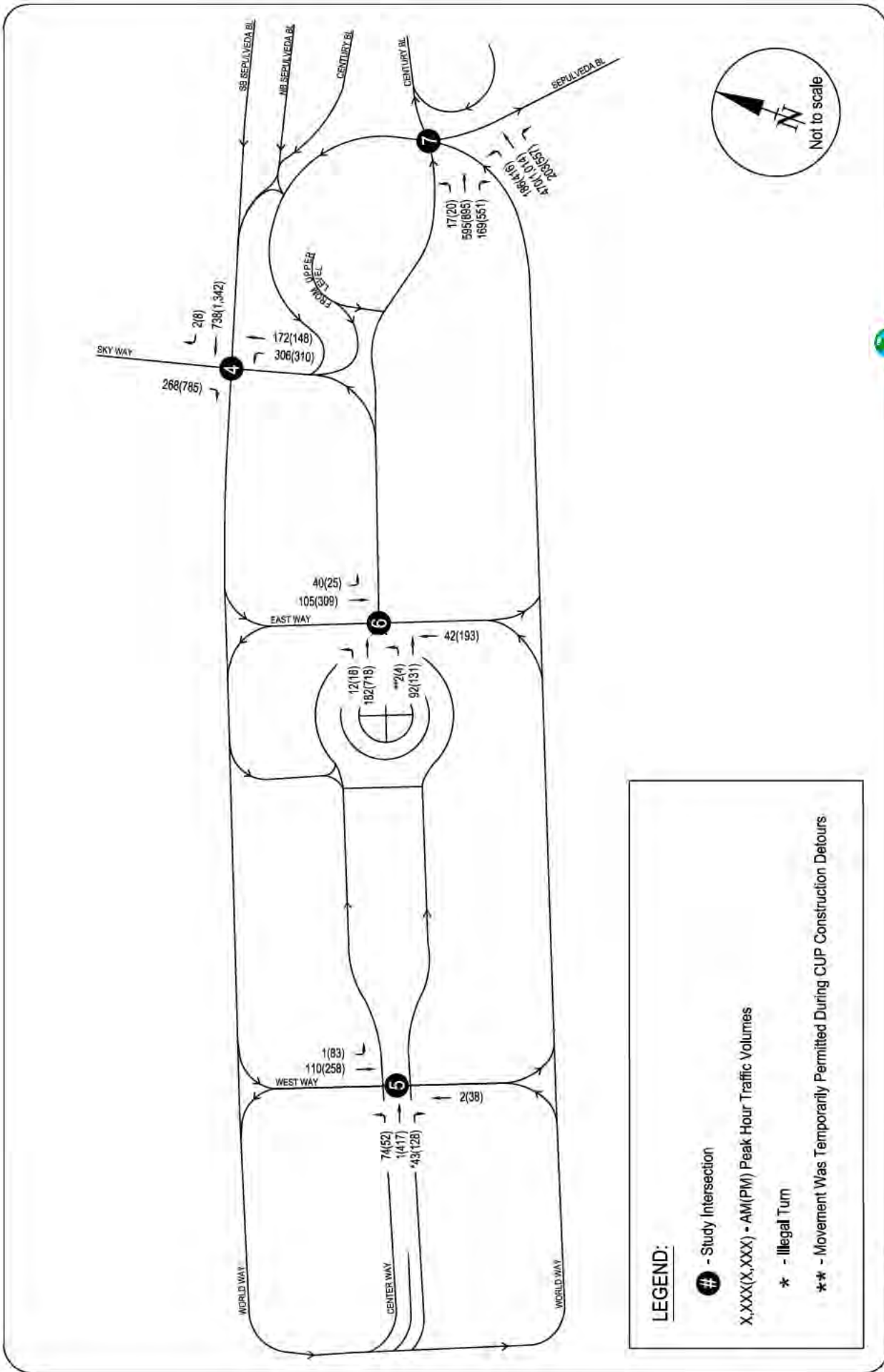

FIGURE 6A
EXISTING (2013) AM / PM PEAK HOUR TRAFFIC VOLUMES - LOWER LEVEL

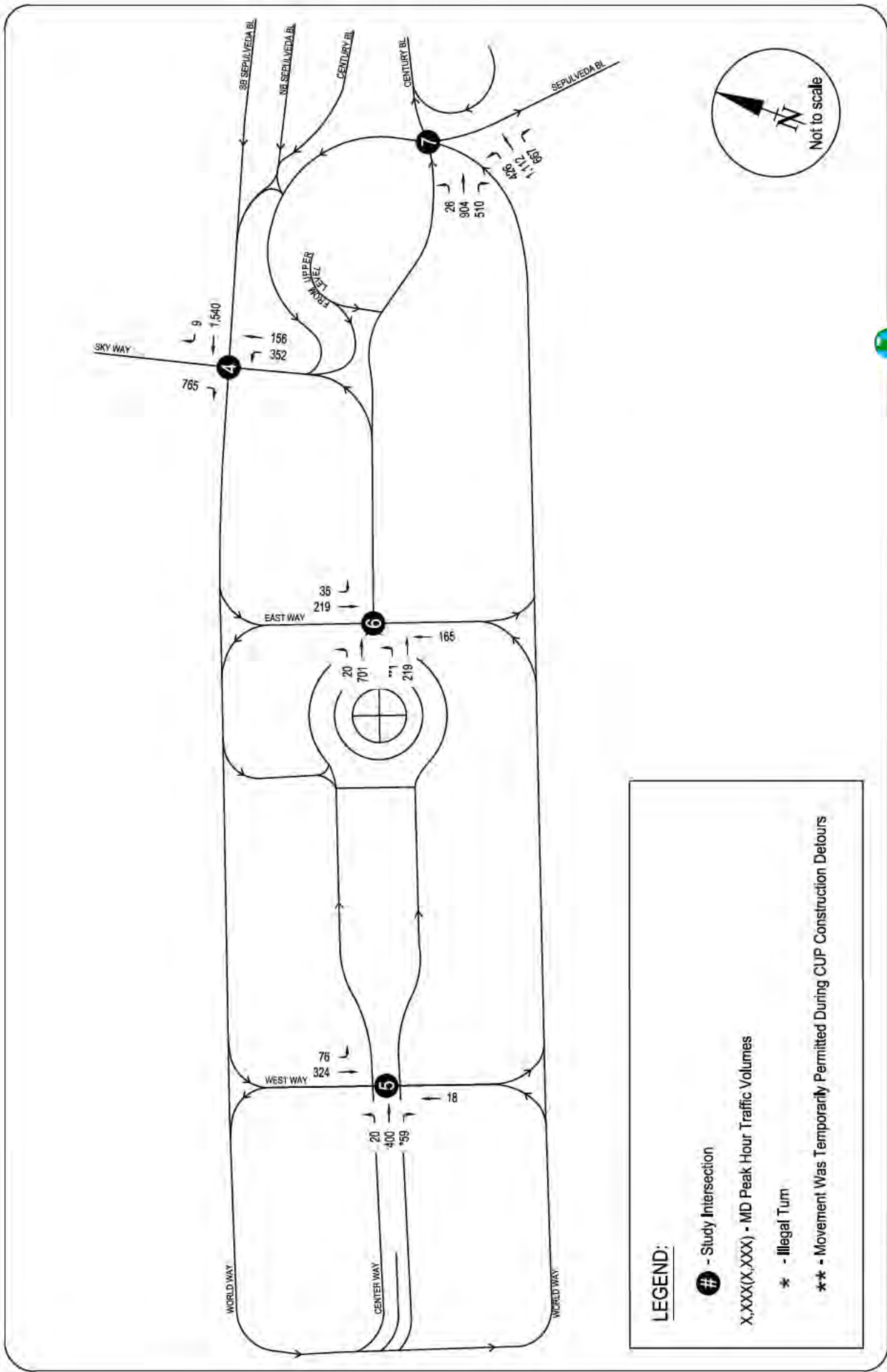

FIGURE 6B
EXISTING (2013) MD PEAK HOUR TRAFFIC VOLUMES - LOWER LEVEL

**TABLE 1
LEVEL OF SERVICE DEFINITIONS FOR SIGNALIZED INTERSECTIONS**

Level of Service	Volume/Capacity Ratio	Definition
A	0.000 - 0.600	EXCELLENT. No vehicle waits longer than one red light and no approach phase is fully used.
B	>0.600 - 0.700	VERY GOOD. An occasional approach phase is fully utilized; many drivers begin to feel somewhat restricted within groups of vehicles.
C	>0.700 - 0.800	GOOD. Occasionally drivers may have to wait through more than one red light; backups may develop behind turning vehicles.
D	>0.800 - 0.900	FAIR. Delays may be substantial during portions of the rush hours, but enough lower volume periods occur to permit clearing of developing lines, preventing excessive backups.
E	>0.900 - 1.000	POOR. Represents the most vehicles intersection approaches can accommodate; may be long lines of waiting vehicles through several signal cycles.
F	> 1.000	FAILURE. Backups from nearby locations or on cross streets may restrict or prevent movement of vehicles out of the intersection approaches. Tremendous delays with continuously increasing queue lengths.

Source: Transportation Research Board, *Transportation Research Circular No. 212, Interim Materials on Highway Capacity*, 1980.

Consistent with the procedures contained in LADOT's *Traffic Study Policies and Procedures*, the "Critical Movement Analysis-Planning", (Transportation Research Board, 1980) method of intersection capacity analysis was used to determine the intersection volume to capacity (V/C) ratio and corresponding level of service at the signalized intersections. Level of service spreadsheets developed by LADOT were used to implement the CMA (Circular 212 Method) methodology.

Existing Levels of Service

The existing traffic volumes presented in Figures 5 and 6 for AM, MD and PM peak hours were used in conjunction with the level of service methodologies, and the current intersection characteristics illustrated in Figure 4, to determine the existing operating conditions at the study intersections.

Table 2 summarizes the results of the intersection capacity analysis for existing conditions at the seven study intersections. The table indicates the existing V/C ratio during the morning, midday and evening peak hours and the corresponding LOS at the study intersections. As indicated in the table, all seven study intersections are currently operating at LOS B or better during the morning, midday and evening peak hours.

Level of service worksheets for Existing (2013) conditions are provided in Attachment B.

FUTURE (2017) WITHOUT PROJECT CONDITIONS

Future traffic conditions in the year 2017 without the Proposed Project have been developed and evaluated. The objective of this analysis is to project future traffic growth and operating conditions, which could be expected to result from projected annual passenger growth at LAX by the year 2017. Also, planned future roadway improvements are identified and included in this evaluation.

Future (2017) without Project Traffic Projections

Traffic projections for the Future (2017) without Project conditions reflect anticipated annual passenger growth occurring at LAX by the year 2017. Based on an overall projection of 78.9 million annual passengers (MAP) by the year 2025, the growth factor was determined to be approximately 1.9% per year. With the project completion date of 2017, the existing 2013 traffic

**TABLE 2
EXISTING (2013) INTERSECTION LEVEL OF SERVICE ANALYSIS**

No.	Intersection	Existing (2013) Conditions					
		AM Peak Hour		MD Peak Hour		PM Peak Hour	
		V/C	LOS	V/C	LOS	V/C	LOS
	<u>Upper Level Intersections</u>						
1.	Sky Way & World Way North	0.489	A	0.468	A	0.377	A
2.	West Way & World Way South	0.496	A	0.472	A	0.328	A
3.	East Way & World Way South	0.660	B	0.551	A	0.423	A
	<u>Lower Level Intersections</u>						
4.	Sky Way & World Way North	0.276	A	0.514	A	0.478	A
5.	West Way & Center Way	0.095	A	0.320	A	0.342	A
6.	East Way & Center Way	0.119	A	0.348	A	0.383	A
7.	World Way South & Center Way	0.273	A	0.585	A	0.556	A

V/C - Volume to Capacity Ratio

LOS - Level of Service

volumes at each intersection were increased by 7.6% to reflect this growth. The resulting Future (2017) without Project traffic volumes are shown in Figures 7A and 7B for the upper level and Figures 8A and 8B for the lower level.

Future Base Roadway Network Improvements

The roadway network for the future base conditions within the CTA has planned improvements occurring along Center Way on the lower level. These improvements are shown in Figures 9 and 10 and include the following:

- Center Way North between West Way and East Way – This improvement consists of providing improved connectivity between World Way on the west and the intersection of Center Way and World Way South on the east. This improvement would widen Center Way North between West Way and East Way from two lanes to three lanes in the eastbound direction. After this improvement, the intersection of Center Way at West Way would have the following lane configurations – the Center Way (N) eastbound approach would provide a shared left-through lane and one through lane; and the Center Way (S) eastbound approach would provide two through lanes. The Center Way (S) eastbound departure would merge to one lane, east of its intersection with West Way.
- At the intersection of Center Way at East Way, the Center Way (N) eastbound approach would provide a shared left-through and two through lanes.
- World Way (S) and Center Way – The improvement at this intersection includes providing an additional separate right-turn lane on the World Way eastbound approach. The approach would provide one left-turn lane, one shared left-through lane, two through lanes, and two right turn lanes to Post Way to access southbound Sepulveda Boulevard.

All these improvements are expected to be completed in 2014.

These planned roadway network changes are included in both the Future (2017) without Project conditions and Future (2017) with Project conditions analyses. The future lane configurations of the study intersections are shown in Figures 11A and 11B for upper and lower levels, respectively.

Future (2017) without Project – Levels of Service

The Future (2017) without Project peak hour traffic volumes were analyzed at each of the study intersections to determine the volume to capacity (V/C) ratio and corresponding level of service. Table 3 presents the results of the Future Year 2017 without Project traffic analysis. As indicated

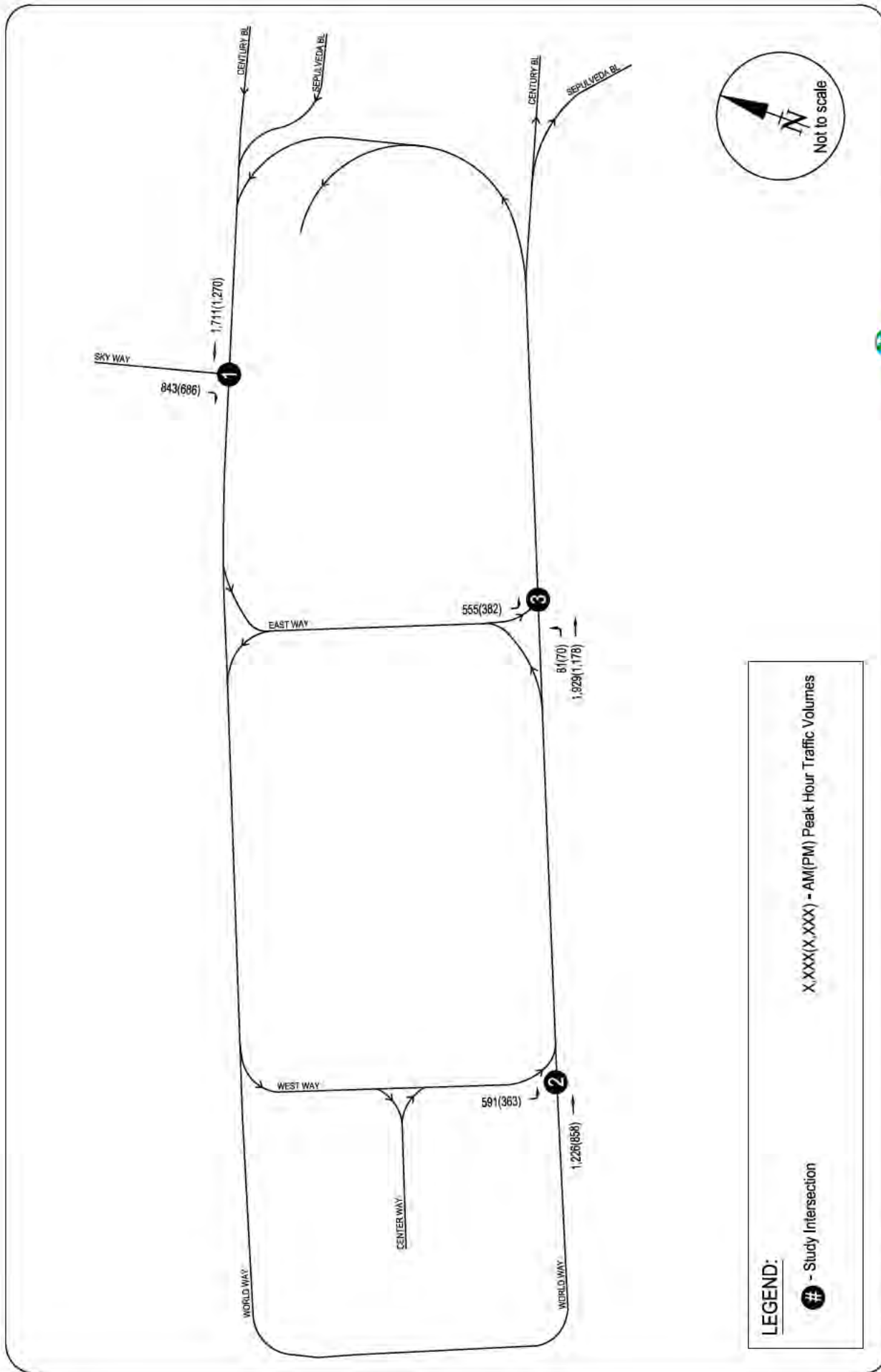

FIGURE 7A
FUTURE (2017) AM / PM PEAK HOUR TRAFFIC VOLUMES - UPPER LEVEL

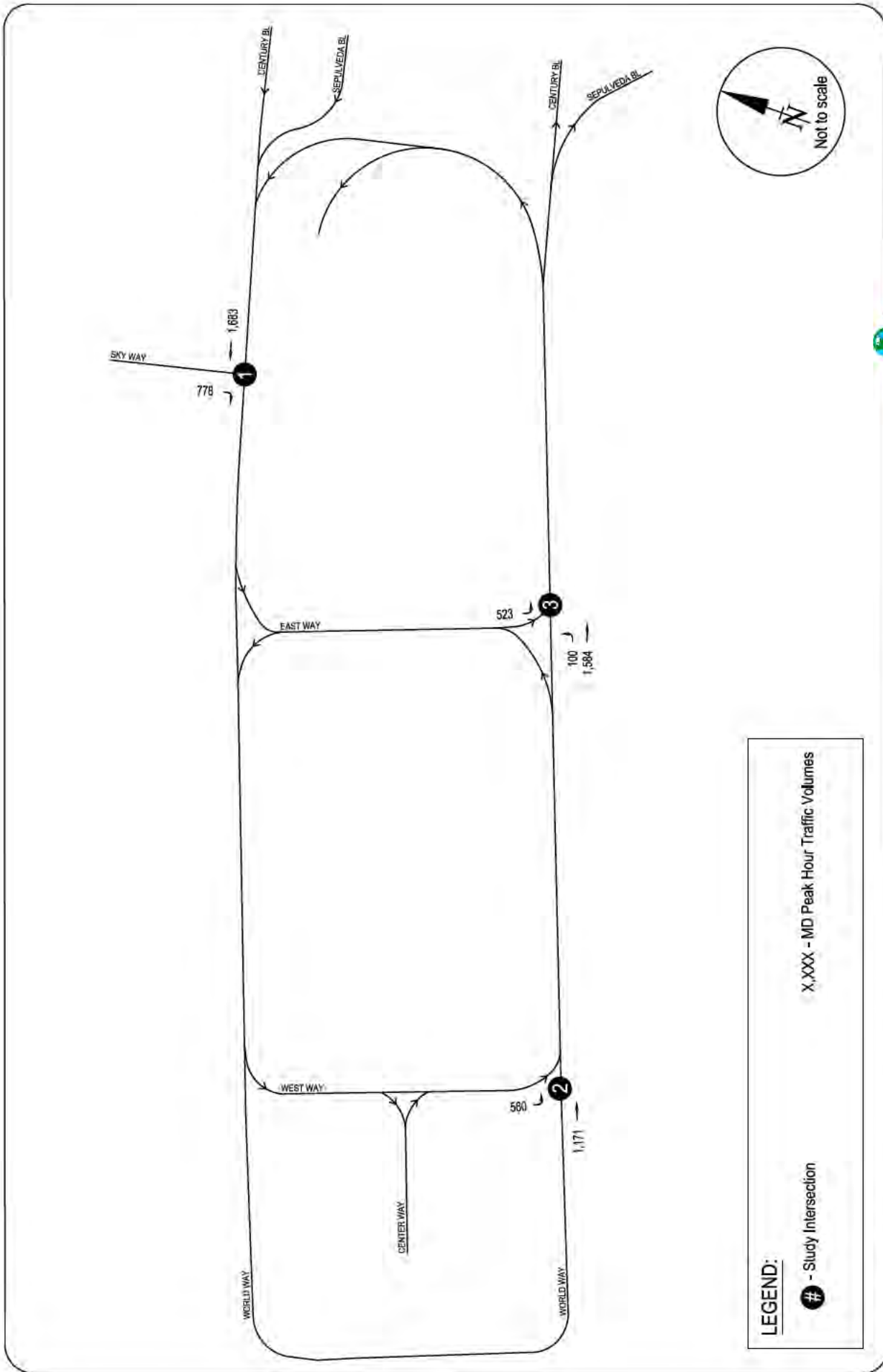

FIGURE 7B
FUTURE (2017) MD PEAK HOUR TRAFFIC VOLUMES - UPPER LEVEL

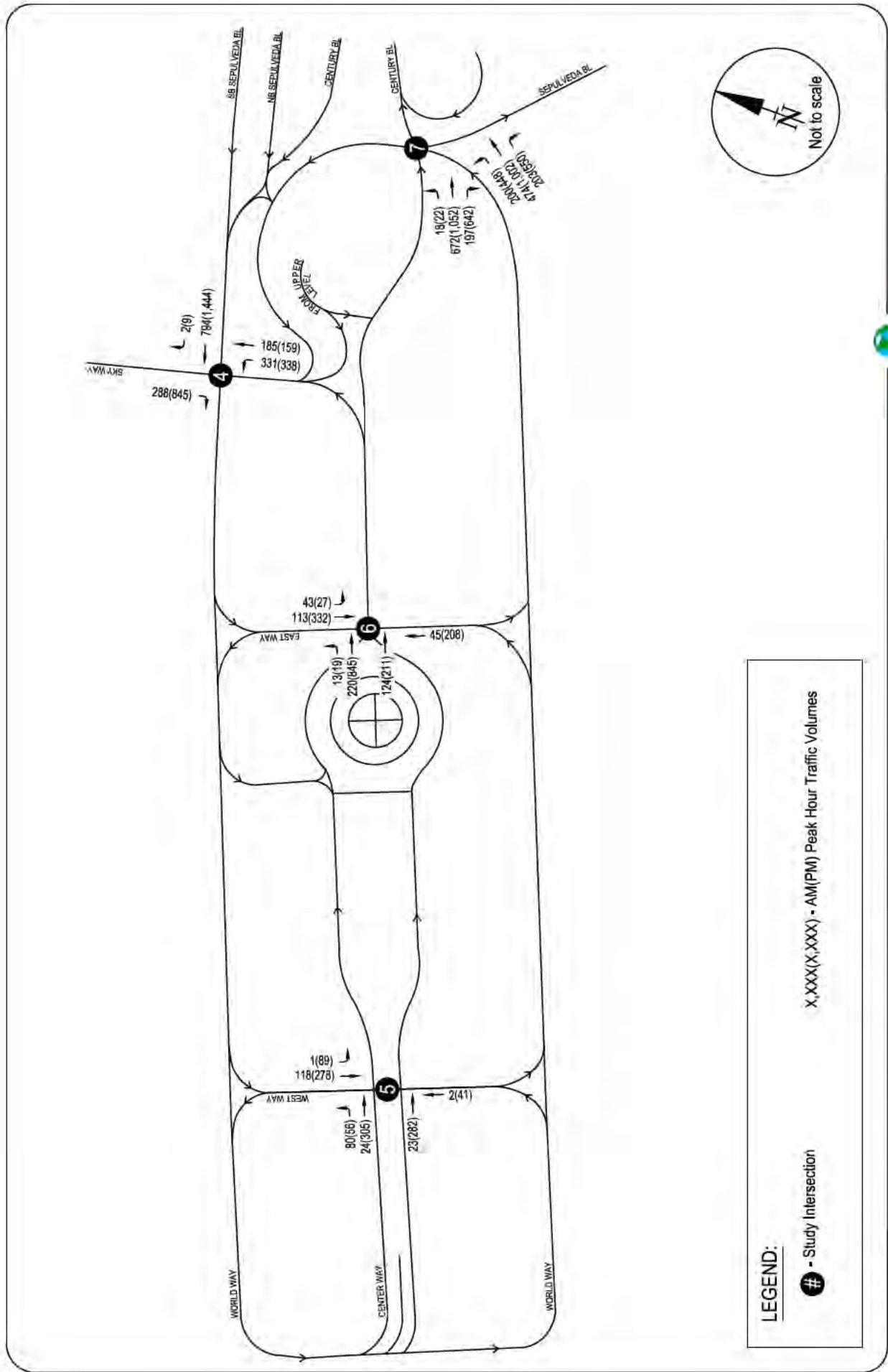

FIGURE 8A
FUTURE (2017) AM / PM PEAK HOUR TRAFFIC VOLUMES - LOWER LEVEL

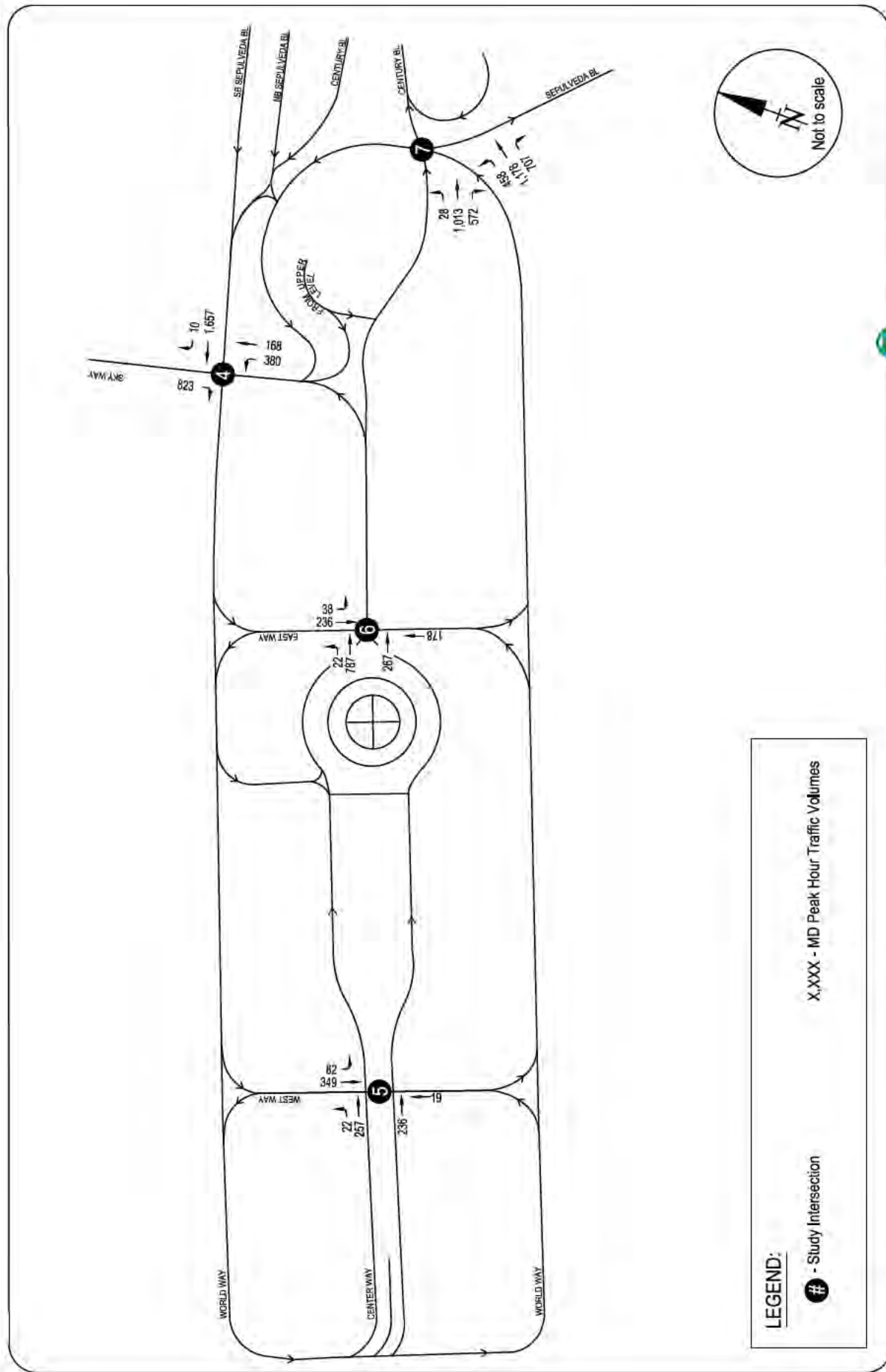
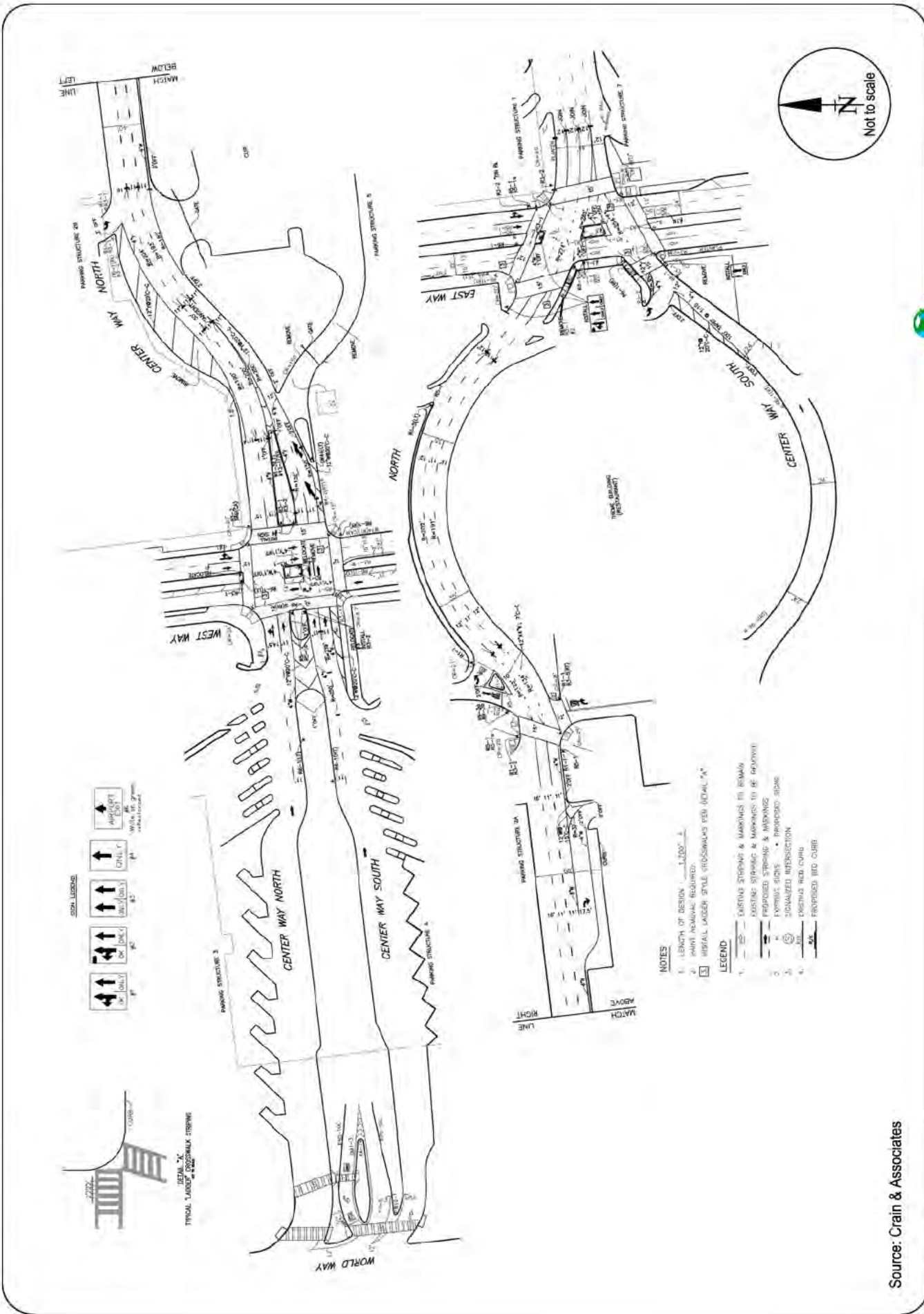

FIGURE 8B
FUTURE (2017) MD PEAK HOUR TRAFFIC VOLUMES - LOWER LEVEL



Source: Crain & Associates

FIGURE 9
CENTER WAY NORTH WIDENING - SIGNING AND STRIPING PLAN

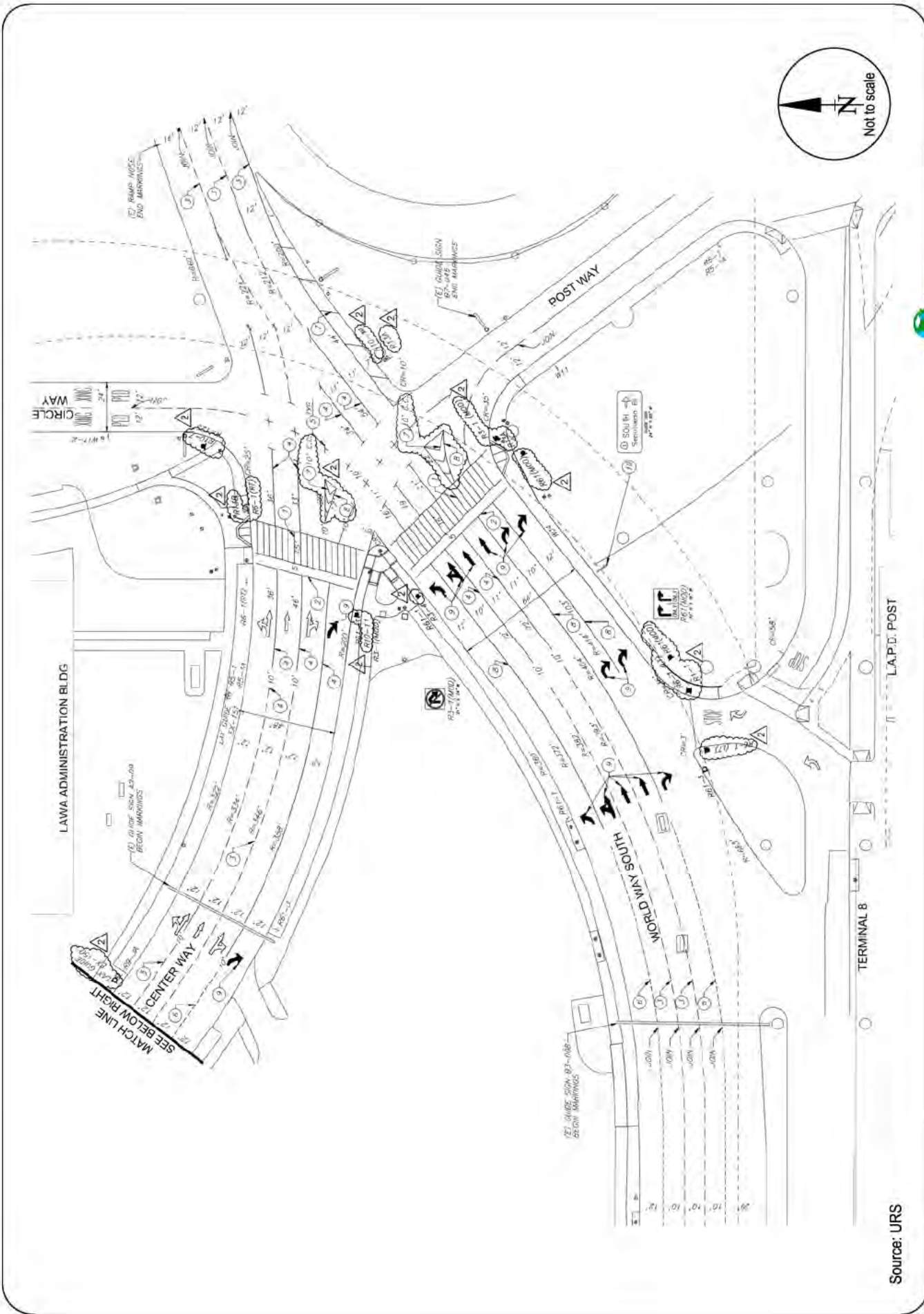

FIGURE 10
WORLD WAY SOUTH AND CENTER WAY ULTIMATE SIGNING AND MARKINGS PLAN

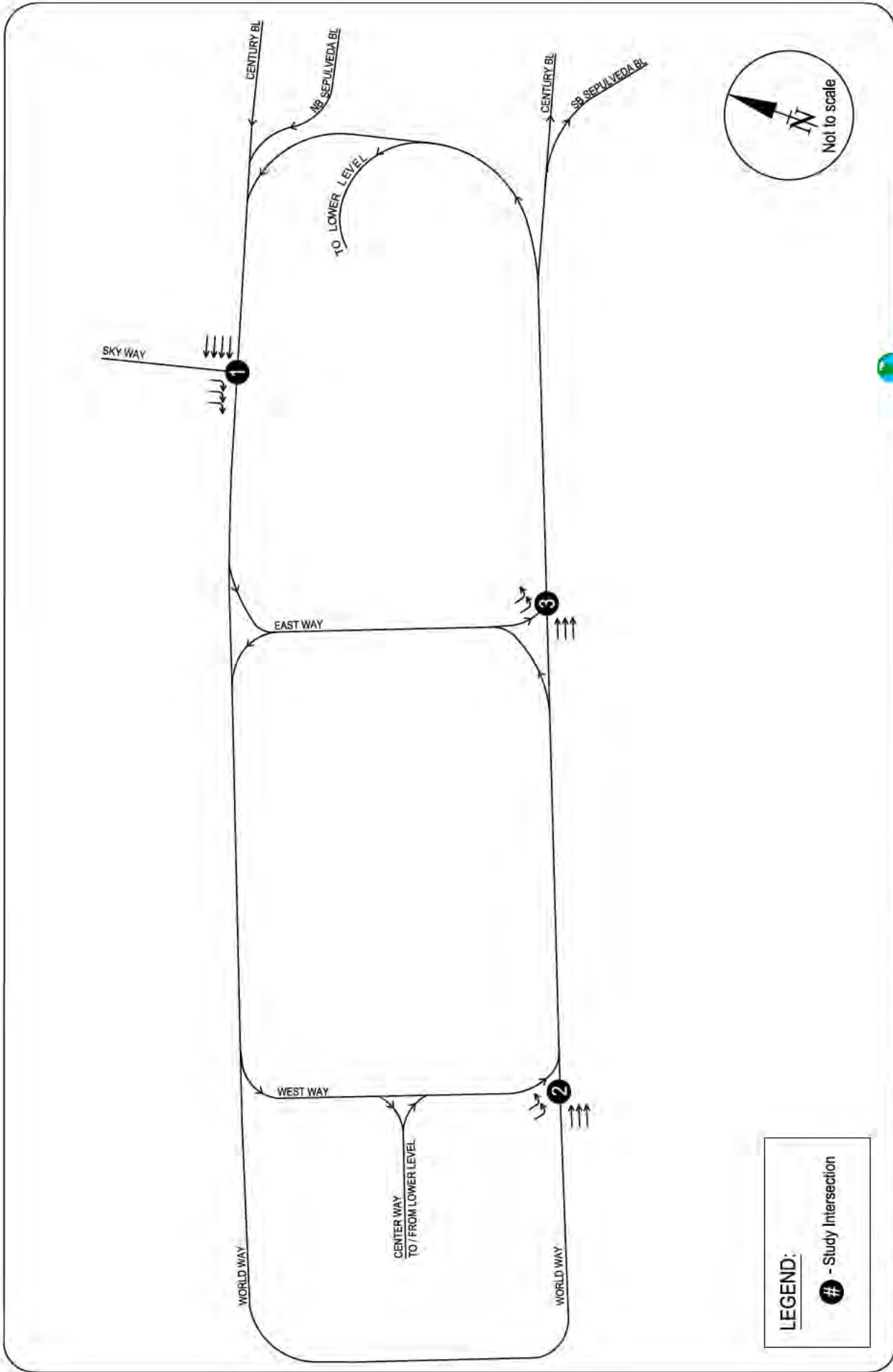

FIGURE 11A
FUTURE (2017) LANE CONFIGURATIONS - UPPER LEVEL

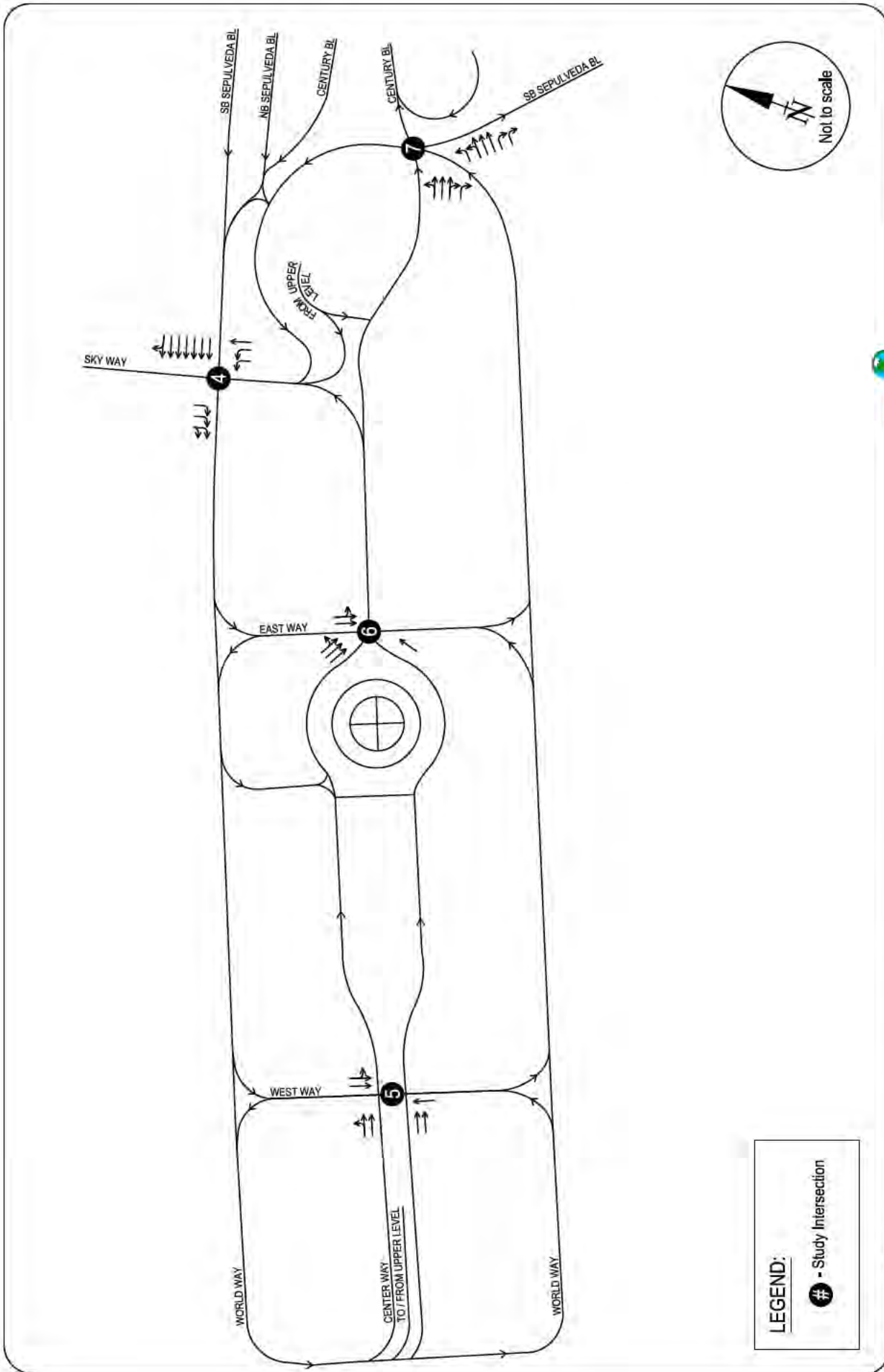

FIGURE 11B
FUTURE (2017) LANE CONFIGURATIONS - LOWER LEVEL

**TABLE 3
SUMMARY OF INTERSECTION LEVEL OF SERVICE ANALYSIS**

No.	Intersection	Peak Hour	Future (2017) Base Conditions		Future (2017) with Project Conditions		Project Increase in V/C	Significant Project Impact
			V/C	LOS	V/C	LOS		
<u>Upper Level Intersections</u>								
1.	Sky Way & World Way North	AM	0.526	A	0.526	A	0.000	No
		MD	0.504	A	0.504	A	0.000	No
		PM	0.406	A	0.406	A	0.000	No
2.	West Way & World Way South	AM	0.534	A	0.548	A	0.014	No
		MD	0.508	A	0.518	A	0.010	No
		PM	0.353	A	0.361	A	0.008	No
3.	East Way & World Way South	AM	0.689	B	0.684	B	-0.005	No
		MD	0.593	A	0.589	A	-0.004	No
		PM	0.439	A	0.436	A	-0.003	No
<u>Lower Level Intersections</u>								
4.	Sky Way & World Way North	AM	0.296	A	0.296	A	0.000	No
		MD	0.553	A	0.553	A	0.000	No
		PM	0.516	A	0.516	A	0.000	No
5.	West Way & Center Way	AM	0.102	A	0.102	A	0.000	No
		MD	0.259	A	0.259	A	0.000	No
		PM	0.265	A	0.265	A	0.000	No
6.	East Way & Center Way	AM	0.147	A	0.147	A	0.000	No
		MD	0.386	A	0.386	A	0.000	No
		PM	0.340	A	0.340	A	0.000	No
7.	World Way South & Center Way	AM	0.290	A	0.290	A	0.000	No
		MD	0.591	A	0.591	A	0.000	No
		PM	0.576	A	0.576	A	0.000	No

V/C - Volume to Capacity Ratio

LOS - Level of Service

in the table, all seven study intersections would operate at LOS B or better during the morning, midday and evening peak hours.

Level of service worksheets for Future (2017) without Project conditions are attached in Attachment C.

FUTURE (2017) WITH PROJECT CONDITIONS

The section provides an evaluation of the Future Year 2017 with Project conditions and summarizes project improvement at Terminal 1, future peak hour traffic volumes with the Proposed Project at key intersections within the Central Terminal Area (CTA) on both the upper (departure) and lower (arrival) levels, and evaluates the future level of service (LOS) and the traffic effects of the Proposed Project at these key CTA intersections.

Terminal 1 Improvements

The modernization of Terminal 1 includes modification to the location of some of the building's existing uses which are expected to improve the utilization of the departure (upper level) and arrival (lower level) curbs and roadways immediately adjacent to the terminal. As indicated in the Project Description section, the Project would relocate the Skycap and ticketing functions to the west end of Terminal 1. Additionally, the new Checked Baggage Inspection System on the Arrival Level would be configured to be accessible only from the western half and center of the Terminal 1 Building. These improvements (in combination with the deactivated / restricted curb adjacent to the exit-only doors on the east) are expected to improve the utilization of the departure (upper level) and arrival (lower level) curbs and roadways immediately adjacent to the terminal by attracting vehicles/passengers to locations further west and away from the intersection of Sky Way/World Way on both the upper and lower levels, reducing vehicle congestion and enhancing vehicular flow past Terminal 1 and through the CTA. The following key improvements are summarized below:

- On the departure level, the new Skycap will attract vehicles dropping off passengers at curbside to a location further west and away from the intersection of Sky Way/World Way North, reducing vehicle congestion and enhancing vehicular flow past Terminal 1 and through the CTA.
- On the departure level, the shifting of the ticketing functions westward will pull the associated passenger demand to the west, increasing the effective length of the curbside

in front of the terminal building which in turn would increase the amount of vehicular queue length for passenger drop-off activity. Moving this activity further west will increase the distance from the intersection of Sky Way/World Way North to the new passenger drop-off zone, increasing the amount of time and distance vehicles have to merge right from through traffic lanes. This is accomplished by providing a restricted use zone on the east end of the terminal building creating a 'deactivated curb' for 185 feet as shown in Figure 12.

- On the arrival level, shifting passenger activity to the west (i.e. those claiming checked bags at the new Checked Baggage Inspection System) will improve the curb utilization. Additional vehicle queue length is created for private vehicles, taxis and car services using the inner curb for passenger pick-up which in turn will reduce congestion, improve safety and vehicular flow. Shifting curbside demand west will also allow vehicles the option of accessing the inner curb through both the first and second access links west of the intersection of Sky Way/World Way. Current passenger demand associated with the disproportionately high utilization of the East Baggage Claim translates into very high utilization of the access link immediately (west of) the intersection which causes roadway congestion similar to that experienced on the upper level roadway as a result of the insufficient merge distance. Shifting all baggage claim activity to the west creates an 'active curb' west of the center of the building, while locating the Checked Baggage Inspection System in the western half of the building creates a 'deactivated curb' east of the building's center. All these modifications translate to improved merging distances, reduced congestion and consequently, improved safety. The existing and proposed arrival level is shown in Figure 13.

Future (2017) with Project Traffic Projections

Currently, on the upper level, vehicles drop-off passengers on the curbside in front of Terminal 1, and exit the CTA by either turning onto East Way, West Way or around World Way. By shifting the Skycap and ticketing functions to the west end of the building and providing a restricted use zone (deactivated curb) for 185 feet on the east end, a portion of the vehicles would shift to using West Way.

On the lower level, vehicles access the inner curb from two access links located between East Way and Sky Way and pick-up passengers from Terminal 1. An access link is provided past East Way to exit the inner curb and access the outer roadway to exit the CTA. Terminal 1 traffic exiting the CTA would use Theme Way via Center Way, West Way via Center Way, or World Way around TBIT. The proposed project emphasizing passenger activity to the west of Terminal 1 would not change the traffic patterns on the lower level.

Departure Level

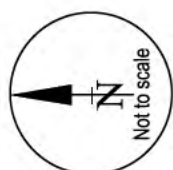
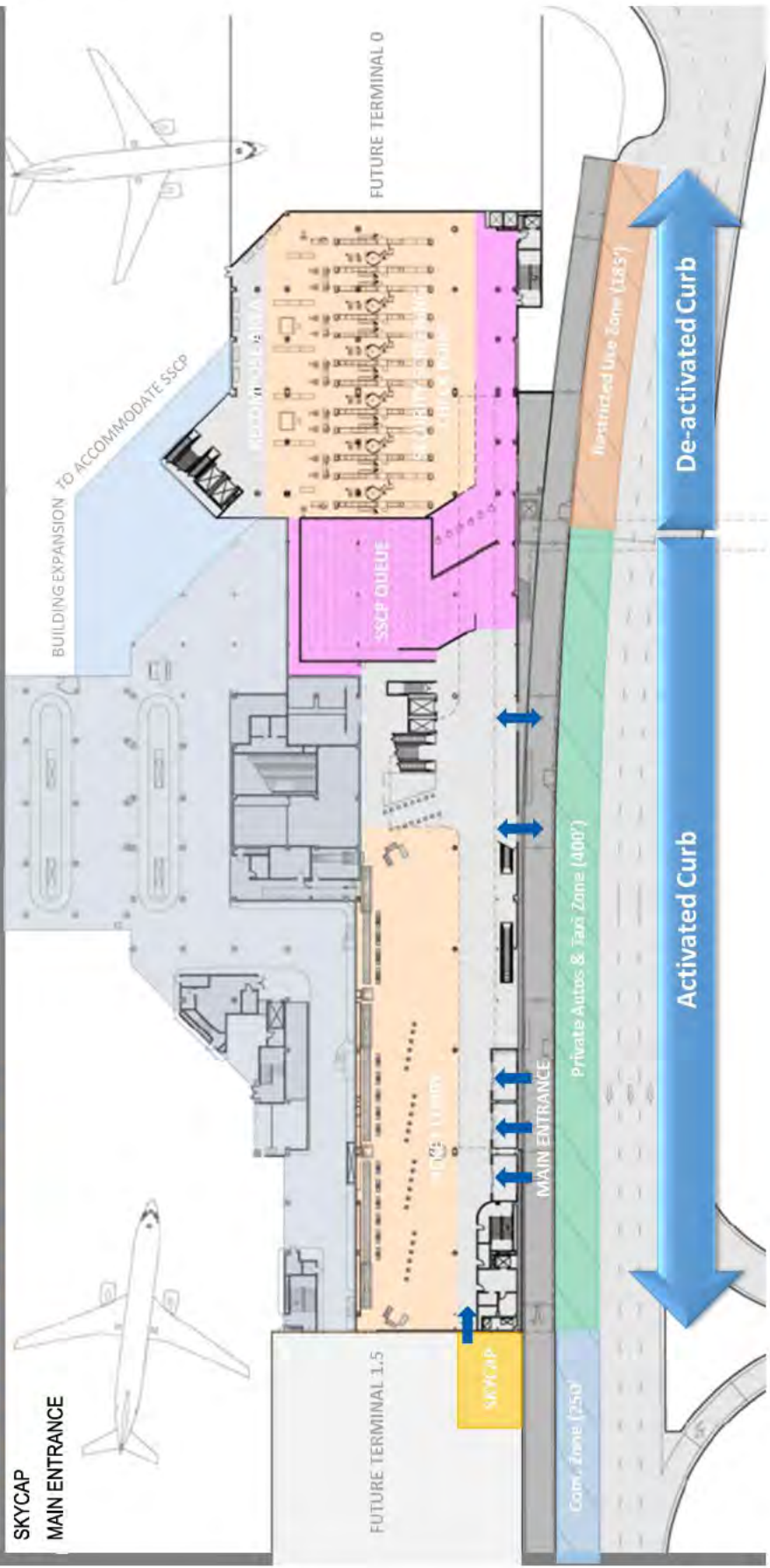

Source: CDM Smith

FIGURE 12
TERMINAL 1 DEPARTURE LEVEL - PROPOSED

EXISTING ARRIVAL LEVEL

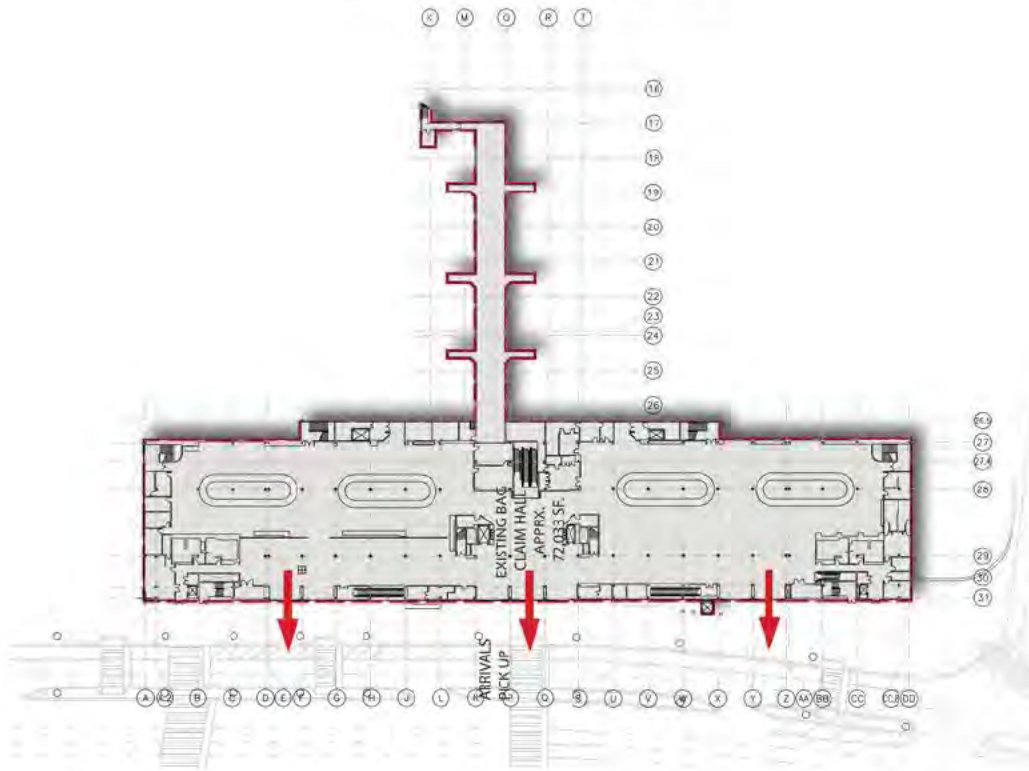

PROPOSED ARRIVAL LEVEL

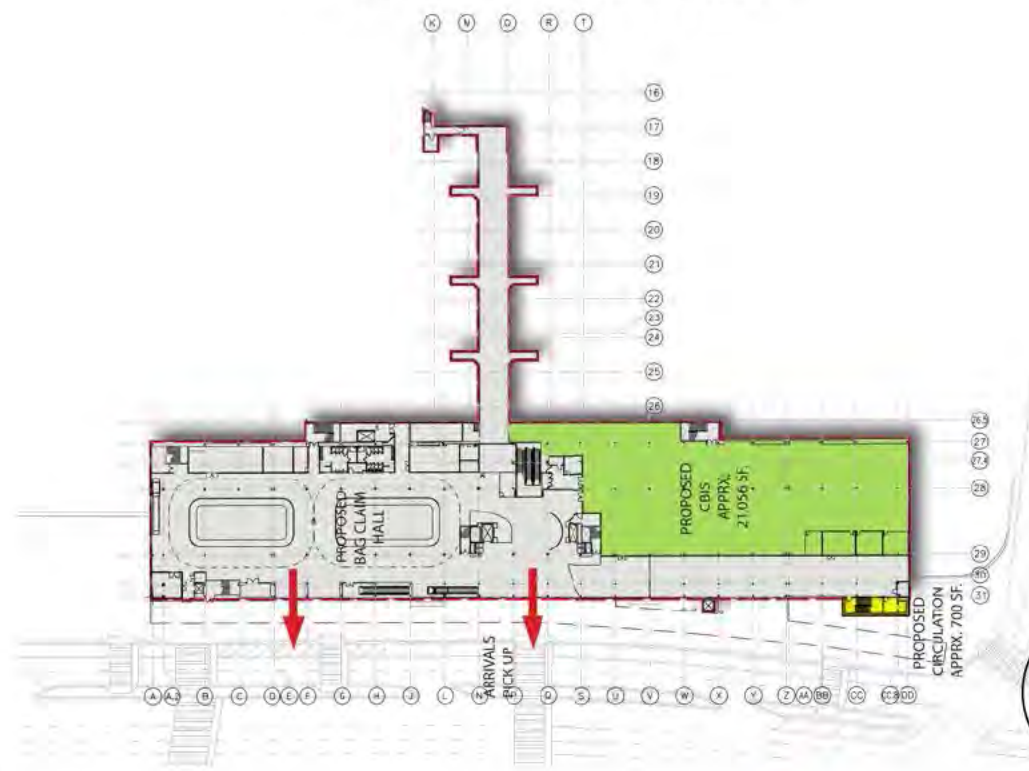

Source: CDM Smith

FIGURE 13
TERMINAL 1 ARRIVAL LEVEL - EXISTING AND PROPOSED

The net traffic expected to be shifted due to improvements by the Proposed Project has been estimated and applied to the Future (2017) Base traffic forecasts. The resulting Future (2017) with Project AM/PM and MD peak hour traffic volumes are shown in Figures 14A and 14B for the upper level and Figures 15A and 15B for the lower level, respectively.

Future (2017) with Project – Levels of Service

The Future (2017) with Project peak hour traffic volumes were analyzed to determine the volume to capacity (V/C) ratio and LOS at each of the studied intersections. Table 3 presents the results of the Future Year 2017 with Project traffic analysis. As indicated in the table, all seven study intersections would continue to operate at LOS B or better during the morning, midday and evening peak hours.

Level of service worksheets for Future (2017) with Project conditions are included in Attachment D.

Project Impacts

The City of Los Angeles Department of Transportation has established threshold criteria that determine if a project has a significant traffic impact at a specific signalized intersection. According to the criteria provided by the City of Los Angeles, a project impact is considered significant if the following conditions are met:

<u>Intersection Condition With Project Traffic</u>		<u>Project-Related Increase in V/C Ratio</u>
<u>LOS</u>	<u>V/C Ratio</u>	
C	0.701 – 0.800	equal to or greater than 0.040
D	0.801 – 0.900	equal to or greater than 0.020
E, F	> 0.900	equal to or greater than 0.010

Using the specified significant impact criteria for intersections shown in Table 3, the traffic impacts at the seven study locations were determined. Table 3 identifies the individual impacts during AM MD and PM peak hours at each of the analysis locations. As indicated in Table 3, the Proposed Project would not trigger the thresholds at any of the analyzed intersections during the morning, midday and evening peak hours under future conditions when compared to Future (2017) Base Conditions.

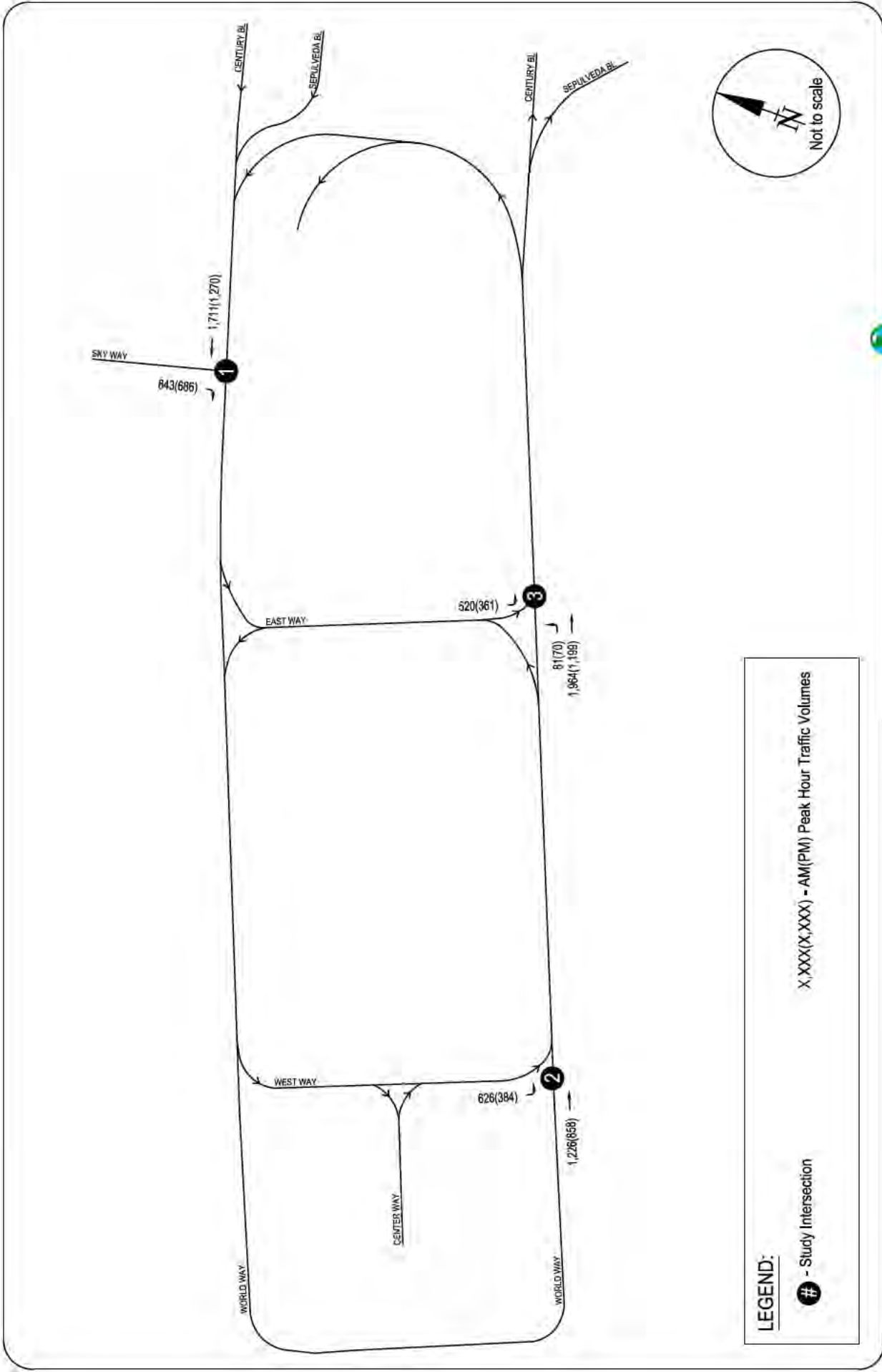

FIGURE 14A
FUTURE (2017) WITH PROJECT AM / PM PEAK HOUR TRAFFIC VOLUMES
UPPER LEVEL

RAJU Associates, Inc.

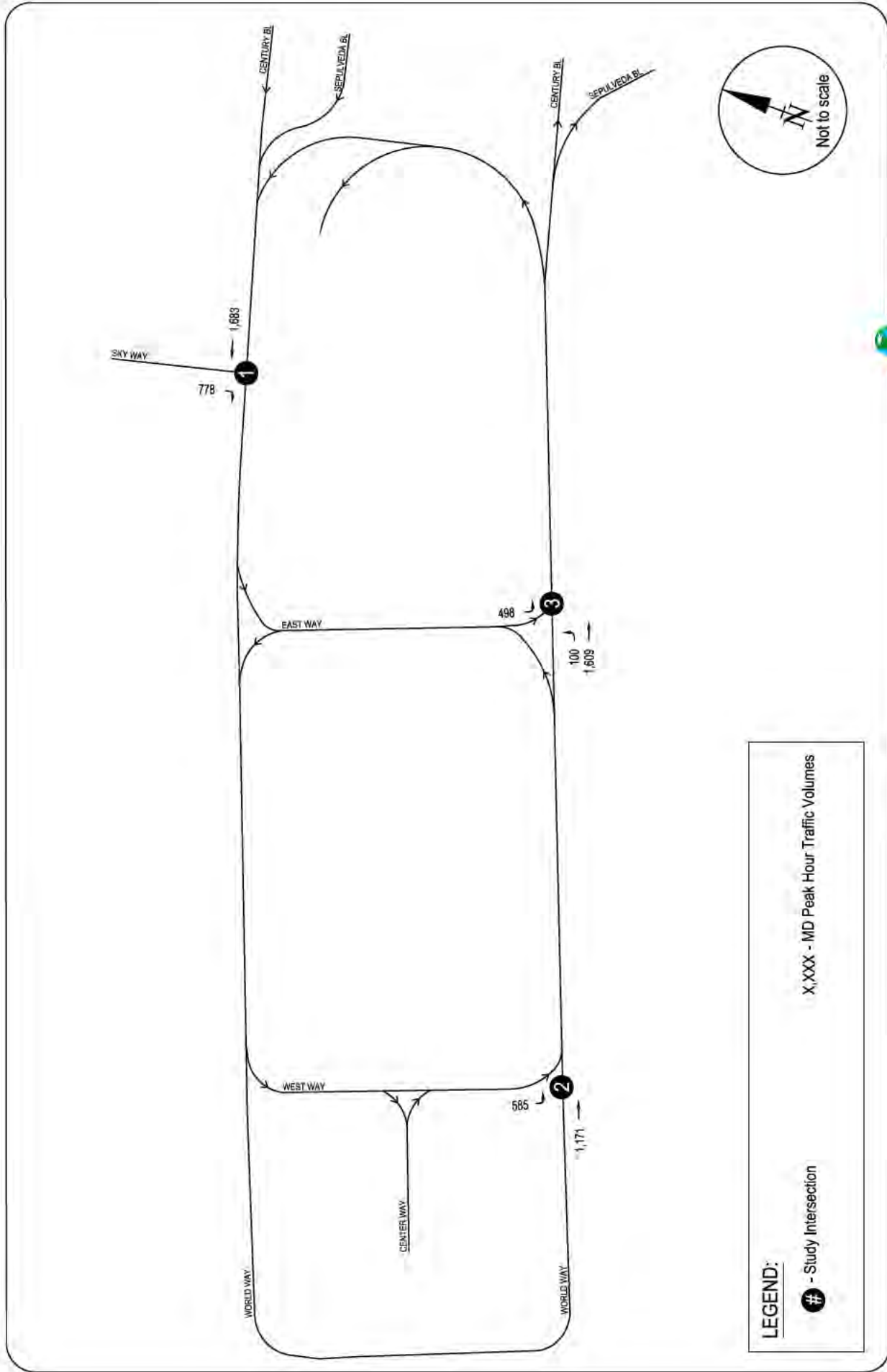

FIGURE 14B
FUTURE (2017) WITH PROJECT MD PEAK HOUR TRAFFIC VOLUMES
UPPER LEVEL

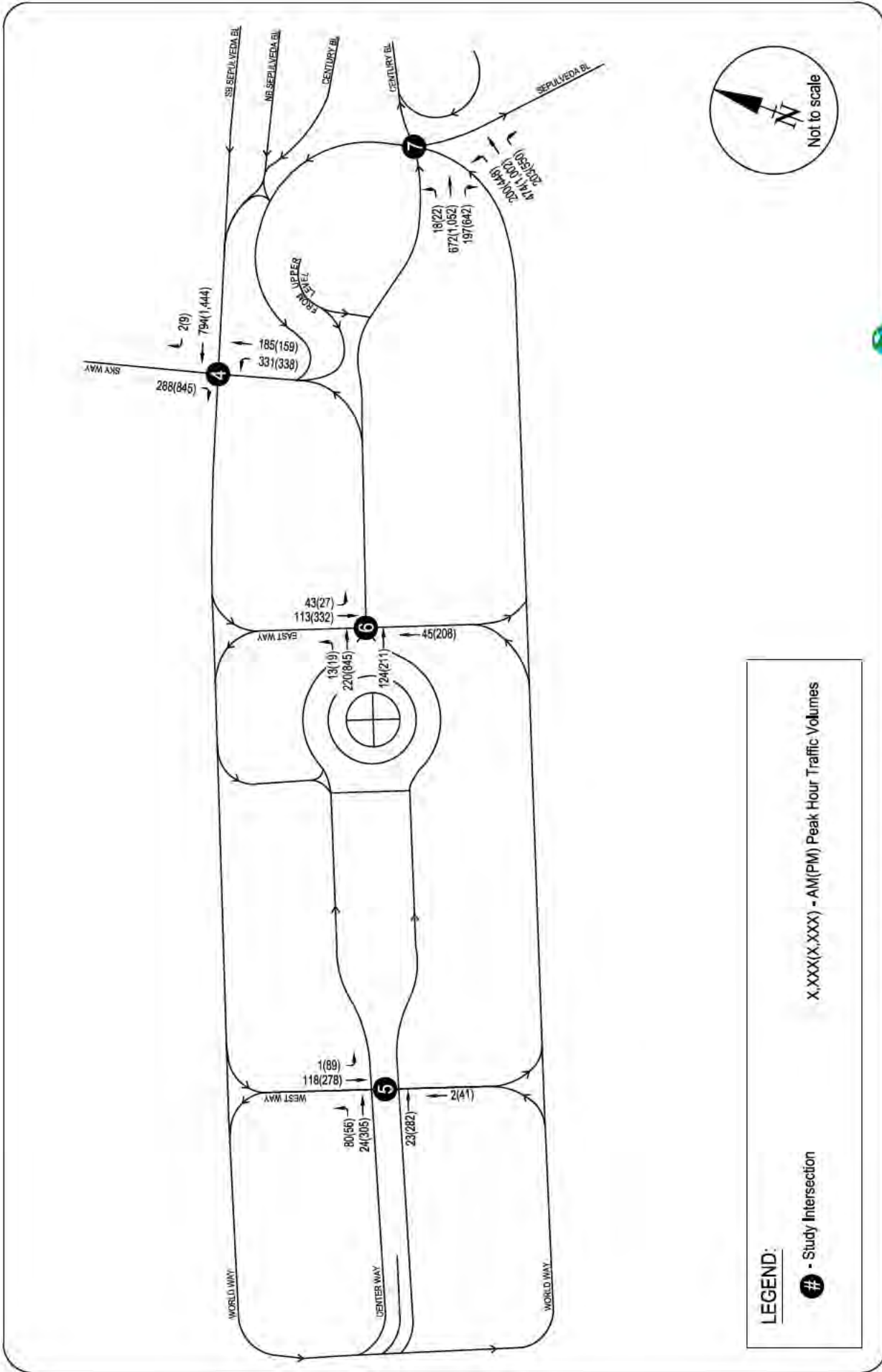

FIGURE 15A
FUTURE (2017) WITH PROJECT AM / PM PEAK HOUR TRAFFIC VOLUMES
LOWER LEVEL

RAJU Associates, Inc.

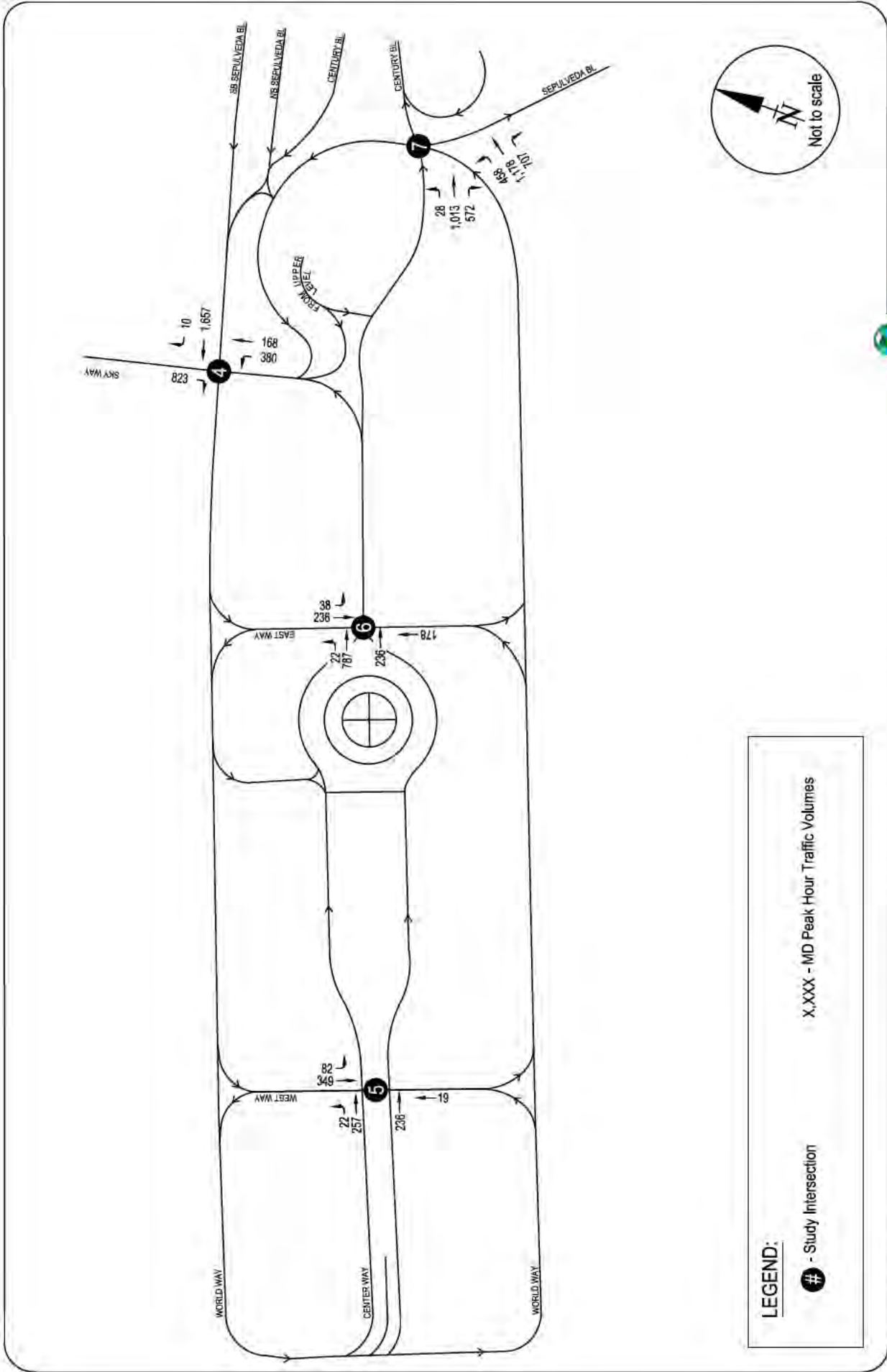

FIGURE 15B
FUTURE (2017) WITH PROJECT MD PEAK HOUR TRAFFIC VOLUMES
LOWER LEVEL

CONCLUSIONS

- The Proposed Project consists of reconstruction and modernization of Terminal 1 to provide specific improvements resulting in improved functionality and extension of life of the building.
- The Project consists of adding approximately 59,150 square feet of building to the existing 306,256 square-foot Terminal 1 facility.
- The Project would result in 14 gates ultimately (of which 13 will accommodate 737-700w and 737-800w aircraft), compared to 15 existing gates. The proposed gates would be able to accommodate the anticipated fleet at Terminal 1.
- On the upper (departure) level, the Proposed Project results in relocation of operations and passenger activity at the curb to the western half of the building increasing the effective length of the curbside in front of the terminal building, which in turn would increase the amount of vehicular queue length for passenger drop-off activity. Moving this activity further west will also increase the distance from the intersection of Sky Way/World Way North to the new passenger drop-off zone, increasing the amount of time and distance vehicles have to merge and reach the curb. Due to these changes, some cars would not be able to turn left on East Way after departing the terminal. Rather, they would continue on World Way North to West Way. As a result, traffic volumes at West Way/World Way South would increase slightly with implementation of the Proposed Project, while traffic volumes at East Way/World Way South would decrease slightly.
- On the lower (arrival) level, shifting passenger activity to the west will improve the curb utilization. Additional space for vehicle queues is created for private vehicles, taxis and other services using the inner curb for passenger pick-up, which in turn will reduce congestion, improve safety and vehicular flow. Shifting curbside demand west will also allow vehicles the option of accessing the inner curb through both the first and second access links west of the intersection of Sky Way/World Way more uniformly. Current passenger demand associated with the disproportionately high utilization of the East Baggage Claim translates into very high utilization of the access link immediately (west of) the intersection which causes roadway congestion similar to that experienced on the upper level roadway as a result of the insufficient merge distance. Shifting all baggage claim activity to the west creates an 'active curb' west of the center of the building, while locating the Checked Baggage Inspection System in the western half of the building creates a 'deactivated curb' east of the building's center. All these modifications translate to improved merging distances, reduced congestion and consequently, improved safety.
- In summary, these improvements would attract vehicles/passengers to locations further west and away from the intersection of Sky Way/World Way on both the upper and lower levels, reducing vehicle congestion and enhancing vehicular flow past Terminal 1 and through the CTA.
- During existing conditions, all study locations are operating at LOS B or better in the AM, MD and PM peak hours.

- During the future (2017) conditions without and with the proposed project, all study intersections would continue to operate at LOS B or better in the AM, MD and PM peak hours.
- The Proposed Project would not cause significant traffic impacts at any of the analysis locations.

This page intentionally left blank.

ATTACHMENT A
EXISTING TRAFFIC COUNTS

This page intentionally left blank.



Metro Traffic Data Inc.
 310 N. Irwin Street - Suite 20
 Hanford, CA 93230
 800-975-6938 Phone/Fax
 www.metrotrafficdata.com

Turning Movement Report

Prepared For: Patrick Tomcheck
 Los Angeles World Airports

LOCATION Sky Way @ World Way North (Lower) LATITUDE 33.945237°
 COUNTY Los Angeles LONGITUDE -118.399521°
 COLLECTION DATE 8/2/2013 WEATHER Sunny and Clear

Time	Northbound		S Leg Peds		Southbound		NW Leg Peds		NE Leg Peds		Westbound			E Leg Peds	
	Left	Thru	EB	WB	Right1	Right2	EB	WB	EB	WB	Thru1	Thru2	Right	NB	SB
7:00 AM - 7:15 AM	73	47	0	1	31	11	5	18	5	18	156	15	0	0	1
7:15 AM - 7:30 AM	77	54	5	0	38	26	4	16	3	16	148	30	0	6	0
7:30 AM - 7:45 AM	79	41	0	0	71	12	6	22	6	22	161	12	1	0	1
7:45 AM - 8:00 AM	77	30	0	1	56	23	7	7	8	7	212	4	1	1	0
8:00 AM - 8:15 AM	66	42	1	2	67	33	2	12	2	12	218	10	0	0	1
8:15 AM - 8:30 AM	78	39	0	1	60	19	11	12	10	12	233	15	1	1	1
8:30 AM - 8:45 AM	78	38	2	3	79	21	12	15	11	15	263	11	1	3	0
8:45 AM - 9:00 AM	38	17	0	0	36	9	1	7	3	9	173	5	2	0	1
TOTAL	566	308	8	8	438	154	48	109	48	111	1564	102	6	11	5

Time	Northbound		S Leg Peds		Southbound		NW Leg Peds		NE Leg Peds		Westbound			E Leg Peds	
	Left	Thru	EB	WB	Right1	Right2	EB	WB	EB	WB	Thru1	Thru2	Right	NB	SB
11:00 AM - 11:15 AM	101	36	1	0	168	31	7	13	7	13	378	18	2	0	3
11:15 AM - 11:30 AM	88	39	2	3	146	34	8	23	8	23	328	14	1	3	0
11:30 AM - 11:45 AM	85	43	3	0	156	30	7	26	7	28	324	25	1	5	0
11:45 AM - 12:00 PM	78	38	0	1	166	34	13	16	11	15	437	16	5	0	1
12:00 PM - 12:15 PM	95	54	2	2	151	63	8	24	9	24	360	20	1	5	2
12:15 PM - 12:30 PM	89	37	5	0	113	61	15	19	16	19	496	26	0	1	0
12:30 PM - 12:45 PM	90	43	1	3	191	59	17	7	17	7	403	26	3	2	0
12:45 PM - 1:00 PM	47	25	1	0	99	26	5	7	4	7	294	14	1	1	0
TOTAL	673	315	15	9	1190	338	80	135	79	136	3020	159	14	17	6

Time	Northbound		S Leg Peds		Southbound		NW Leg Peds		NE Leg Peds		Westbound			E Leg Peds	
	Left	Thru	EB	WB	Right1	Right2	EB	WB	EB	WB	Thru1	Thru2	Right	NB	SB
4:00 PM - 4:15 PM	93	37	3	1	226	34	19	20	15	20	383	15	2	3	1
4:15 PM - 4:30 PM	88	41	1	2	176	35	16	11	17	11	497	24	1	0	2
4:30 PM - 4:45 PM	98	42	1	0	220	45	27	9	27	9	418	16	0	1	0
4:45 PM - 5:00 PM	90	32	2	1	144	43	26	15	24	15	405	18	1	3	0
5:00 PM - 5:15 PM	92	35	4	2	157	63	24	11	25	11	332	31	2	0	0
5:15 PM - 5:30 PM	79	35	4	0	147	51	23	24	21	24	341	15	3	9	0
5:30 PM - 5:45 PM	68	41	0	1	193	28	10	5	11	5	335	21	3	0	1
5:45 PM - 6:00 PM	71	37	2	0	113	33	15	11	15	11	255	12	0	0	0
TOTAL	679	300	17	7	1376	332	160	106	155	106	2966	152	12	16	4

PEAK HOUR	Northbound		S Leg Peds		Southbound		NW Leg Peds		NE Leg Peds		Westbound			E Leg Peds	
	Left	Thru	EB	WB	Right1	Right2	EB	WB	EB	WB	Thru1	Thru2	Right	NB	SB
7:45 AM - 8:45 AM	299	149	3	7	242	82	32	46	31	46	926	40	3	5	2
11:45 AM - 12:45 PM	352	172	8	6	621	217	53	66	53	65	1696	88	9	8	3
4:00 PM - 5:00 PM	369	152	7	4	766	157	88	55	83	55	1703	73	4	7	3

	PHF
AM	0.904
MID	0.960
PM	0.935

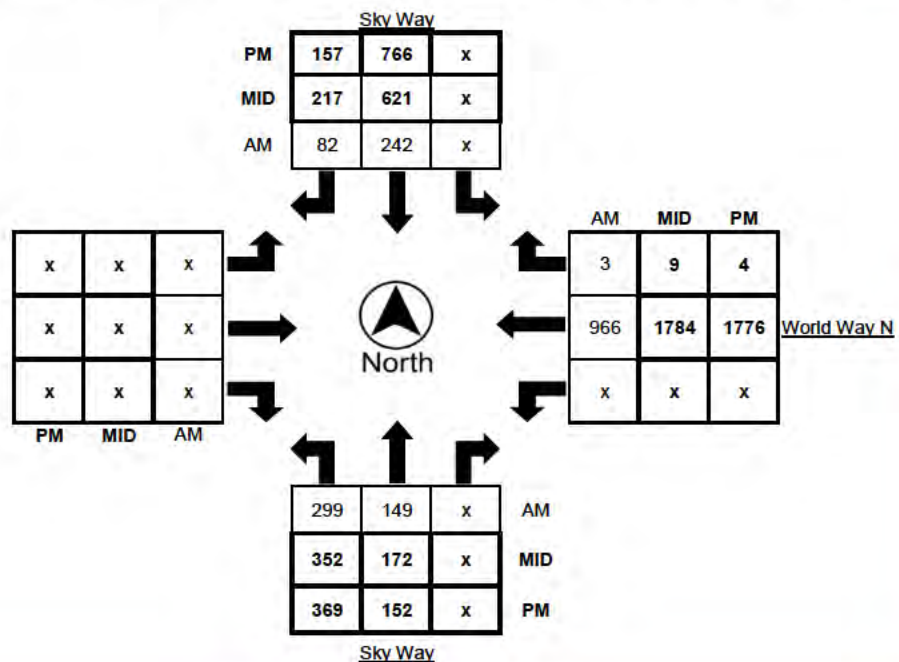



Metro Traffic Data Inc.
 310 N. Irwin Street - Suite 20
 Hanford, CA 93230
 800-975-6938 Phone/Fax
 www.metrotrafficdata.com

Turning Movement Report

Prepared For: Patrick Tomcheck
 Los Angeles World Airports

LOCATION: Center Way @ East Way
 COUNTY: Los Angeles
 COLLECTION DATE: 8/2/2013
 LATITUDE: 33.944218°
 LONGITUDE: -118.401430°
 WEATHER: Sunny and Clear

Time	NB			S Leg Peds			Southbound				Eastbound				WN Leg Peds		WS Leg Peds		E Leg Peds	
	Thru	EB	WB	Left	Thru	Left1	Left2	Thru1	Thru2	NB	SB	NB	SB	NB	SB	NB	SB			
7 00 AM - 7 15 AM	5	0	0	7	23	4	0	25	13	0	1	0	0	1	0	1	0			
7 15 AM - 7 30 AM	6	2	0	10	27	2	1	66	30	0	2	0	4	2	2	2	2			
7 30 AM - 7 45 AM	14	1	0	9	25	4	0	54	26	1	2	1	2	0	0	3	3			
7 45 AM - 8 00 AM	17	1	0	14	30	2	1	37	23	0	1	1	0	1	1	1	1			
8 00 AM - 8 15 AM	18	1	0	7	22	5	2	47	24	0	0	3	2	1	4	4	4			
8 15 AM - 8 30 AM	15	0	0	11	41	1	0	46	19	0	3	9	3	4	4	3	3			
8 30 AM - 8 45 AM	23	2	0	8	37	4	0	71	20	2	2	1	4	1	5	5	5			
8 45 AM - 9 00 AM	18	3	0	11	63	3	1	55	16	0	10	1	7	2	1	1	1			
TOTAL	116	10	0	77	268	25	5	401	171	3	21	16	22	12	19					

Time	NB			S Leg Peds			Southbound				Eastbound				WN Leg Peds		WS Leg Peds		E Leg Peds	
	Thru	EB	WB	Left	Thru	Left1	Left2	Thru1	Thru2	NB	SB	NB	SB	NB	SB	NB	SB			
11 00 AM - 11 15 AM	42	1	0	9	48	3	1	206	43	3	3	7	2	4	1	1	1			
11 15 AM - 11 30 AM	38	1	1	6	53	2	0	166	58	10	3	7	1	3	3	3	3			
11 30 AM - 11 45 AM	43	5	1	9	61	9	0	171	62	4	4	14	2	11	1	1	1			
11 45 AM - 12 00 PM	42	2	1	11	57	6	0	158	56	9	4	11	4	7	4	4	4			
12 00 PM - 12 15 PM	47	4	0	9	63	15	1	218	40	14	0	24	2	4	3	3	3			
12 15 PM - 12 30 PM	29	5	0	11	70	6	0	213	31	1	5	3	7	6	2	2	2			
12 30 PM - 12 45 PM	51	2	0	12	105	5	1	179	42	1	3	4	5	9	1	1	1			
12 45 PM - 1 00 PM	48	2	1	10	98	3	3	211	41	8	2	10	2	9	8	8	8			
TOTAL	340	22	4	77	555	49	6	1522	373	50	24	80	25	53	23					

Time	NB			S Leg Peds			Southbound				Eastbound				WN Leg Peds		WS Leg Peds		E Leg Peds	
	Thru	EB	WB	Left	Thru	Left1	Left2	Thru1	Thru2	NB	SB	NB	SB	NB	SB	NB	SB			
4 00 PM - 4 15 PM	41	2	1	8	107	2	0	186	37	8	2	8	5	2	2	2	2			
4 15 PM - 4 30 PM	61	0	0	2	104	15	1	175	26	1	2	4	2	0	1	1	1			
4 30 PM - 4 45 PM	68	0	0	4	86	11	2	170	50	1	5	2	5	4	3	3	3			
4 45 PM - 5 00 PM	48	1	1	8	64	9	1	226	55	3	1	4	3	0	3	3	3			
5 00 PM - 5 15 PM	48	0	0	10	66	7	1	208	37	5	8	7	0	2	5	5	5			
5 15 PM - 5 30 PM	41	0	1	7	92	3	0	205	31	8	0	6	1	1	2	2	2			
5 30 PM - 5 45 PM	55	6	1	3	79	4	1	150	34	4	3	8	9	0	1	1	1			
5 45 PM - 6 00 PM	49	2	1	5	72	4	2	155	29	1	4	2	3	1	3	3	3			
TOTAL	411	11	5	47	670	55	8	1475	299	31	25	41	28	10	20					

PEAK HOUR	NB			S Leg Peds			Southbound				Eastbound				WN Leg Peds		WS Leg Peds		E Leg Peds	
	Thru	EB	WB	Left	Thru	Left1	Left2	Thru1	Thru2	NB	SB	NB	SB	NB	SB	NB	SB			
8 00 AM - 9 00 AM	74	6	0	37	163	13	3	219	79	2	15	14	16	8	13					
12 00 PM - 1 00 PM	175	13	1	42	336	29	5	821	154	24	10	41	16	28	14					
4 00 PM - 5 00 PM	218	3	2	22	361	37	4	757	168	13	10	18	15	6	9					

	PHF
AM	0.880
MID	0.943
PM	0.953

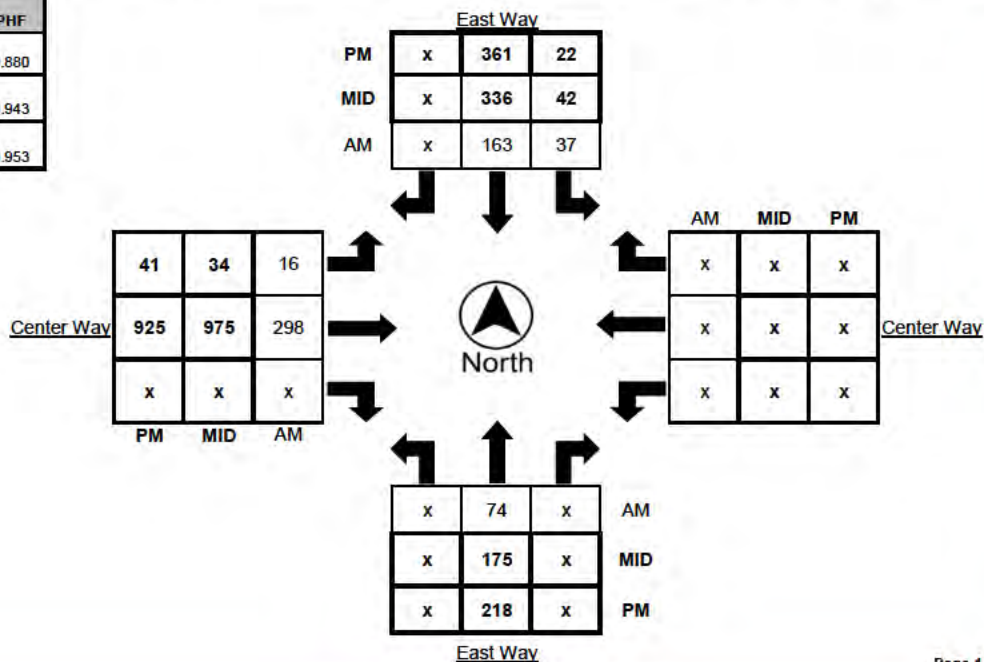



Metro Traffic Data Inc.
 310 N. Irwin Street - Suite 20
 Hanford, CA 93230
 800-975-6938 Phone/Fax
 www.metrotrafficdata.com

Turning Movement Report

Prepared For: Patrick Tomcheck
 Los Angeles World Airports

LOCATION Center Way @ West Way
 COUNTY Los Angeles
 COLLECTION DATE 8/16/2013

LATITUDE 33.943785°
 LONGITUDE -118.405655°
 WEATHER Sunny and Clear

Time	NB			S Leg Peds			Southbound			N Leg Peds			Eastbound				W Leg Peds		E Leg Peds	
	Thru	EB	WB	Left	Thru	Right	Left1	Left2	Thru	Right	Left1	Left2	Thru	Right	NB	SB	NB	SB		
7 00 AM - 7 15 AM	1	3	10	0	18	x	x	x	16	0	9	1	3	3	18					
7 15 AM - 7 30 AM	0	22	1	0	34	x	x	x	15	0	7	0	3	8	9					
7 30 AM - 7 45 AM	1	12	9	0	19	x	x	x	18	0	11	2	2	10	4					
7 45 AM - 8 00 AM	0	13	7	1	39	x	x	x	25	1	16	5	2	5	7					
8 00 AM - 8 15 AM	2	6	10	0	28	x	x	x	8	15	13	6	1	4	9					
8 15 AM - 8 30 AM	1	7	10	4	29	x	x	x	14	20	12	1	3	3	1					
8 30 AM - 8 45 AM	5	5	14	5	49	x	x	x	10	25	20	2	0	3	5					
8 45 AM - 9 00 AM	2	6	6	4	29	x	x	x	7	37	12	2	2	8	1					
TOTAL	12	74	67	14	245	0	0	0	113	98	100	19	16	44	54					

Time	NB			S Leg Peds			Southbound			N Leg Peds			Eastbound				W Leg Peds		E Leg Peds	
	Thru	EB	WB	Left	Thru	Right	Left1	Left2	Thru	Right	Left1	Left2	Thru	Right	NB	SB	NB	SB		
11 00 AM - 11 15 AM	4	3	3	15	75	x	x	x	6	98	12	1	2	1	3					
11 15 AM - 11 30 AM	7	4	5	12	89	x	x	x	4	96	15	0	2	4	3					
11 30 AM - 11 45 AM	4	4	2	25	70	x	x	x	8	111	21	1	0	15	2					
11 45 AM - 12 00 PM	3	8	0	24	90	x	x	x	2	95	11	3	0	10	2					
12 00 PM - 12 15 PM	2	9	4	33	90	x	x	x	8	117	10	0	0	1	1					
12 15 PM - 12 30 PM	4	4	8	27	97	x	x	x	15	67	24	0	1	2	11					
12 30 PM - 12 45 PM	3	2	2	36	96	x	x	x	7	124	21	1	1	1	6					
12 45 PM - 1 00 PM	13	1	2	31	84	x	x	x	6	113	28	0	4	4	4					
TOTAL	40	35	26	203	691	0	0	0	56	821	142	6	10	38	32					

Time	NB			S Leg Peds			Southbound			N Leg Peds			Eastbound				W Leg Peds		E Leg Peds	
	Thru	EB	WB	Left	Thru	Right	Left1	Left2	Thru	Right	Left1	Left2	Thru	Right	NB	SB	NB	SB		
4 00 PM - 4 15 PM	3	11	3	33	78	x	x	x	4	122	25	0	3	6	2					
4 15 PM - 4 30 PM	3	11	4	33	77	x	x	x	9	121	24	3	1	8	0					
4 30 PM - 4 45 PM	13	8	2	19	65	x	x	x	20	104	22	0	3	3	0					
4 45 PM - 5 00 PM	4	6	3	17	69	x	x	x	11	70	20	0	3	2	1					
5 00 PM - 5 15 PM	6	9	3	30	86	x	x	x	11	105	28	3	0	4	0					
5 15 PM - 5 30 PM	14	14	1	31	61	x	x	x	16	106	36	1	0	9	4					
5 30 PM - 5 45 PM	11	9	0	15	52	x	x	x	10	97	39	0	0	1	1					
5 45 PM - 6 00 PM	7	13	4	7	59	x	x	x	15	109	25	0	0	1	0					
TOTAL	61	81	20	185	547	0	0	0	96	834	219	7	10	34	8					

PEAK HOUR	NB			S Leg Peds			Southbound			N Leg Peds			Eastbound				W Leg Peds		E Leg Peds	
	Thru	EB	WB	Left	Thru	Right	Left1	Left2	Thru	Right	Left1	Left2	Thru	Right	NB	SB	NB	SB		
7 45 AM - 8 45 AM	8	31	41	10	145	0	0	0	57	61	61	14	6	15	22					
12 00 PM - 1 00 PM	22	16	16	127	367	0	0	0	36	421	83	1	6	8	22					
4 15 PM - 5 15 PM	26	34	12	99	297	0	0	0	51	400	94	6	7	17	1					

	PHF
AM	0.797
MID	0.965
PM	0.889

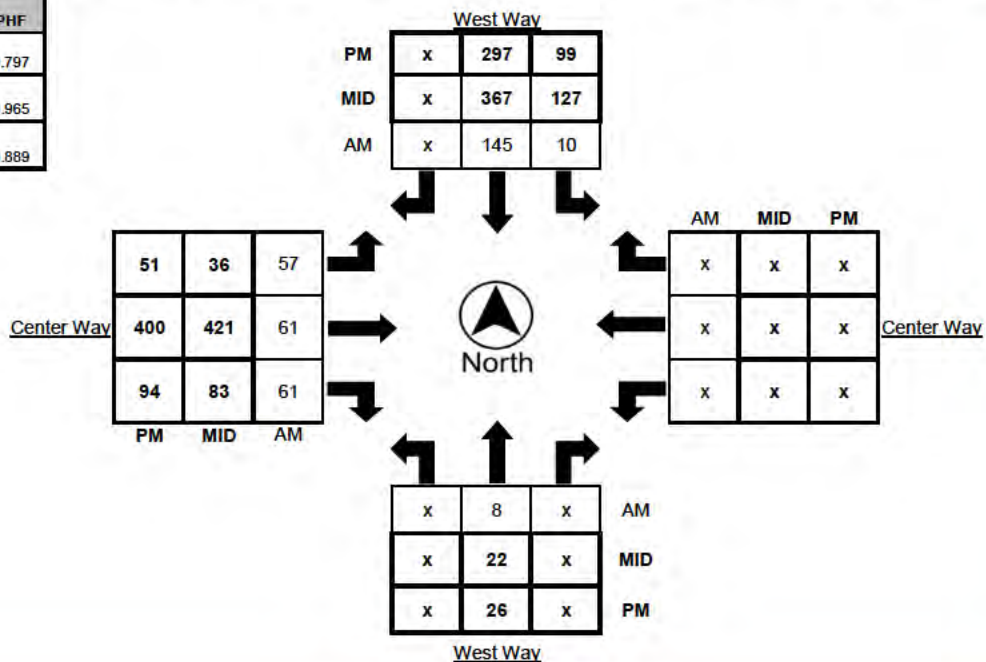



Metro Traffic Data Inc.
 310 N. Irwin Street - Suite 20
 Hanford, CA 93230
 800-975-6938 Phone/Fax
 www.metrotrafficdata.com

Turning Movement Report

Prepared For: Patrick Tomcheck
 Los Angeles World Airports

LOCATION Sky Way @ World Way North (Upper) LATITUDE 33 945459°
 COUNTY Los Angeles LONGITUDE -118 399657°
 COLLECTION DATE 8/2/2013 WEATHER Sunny and Clear

Time	Northbound				Southbound				Eastbound				Westbound						
	Left	Thru	Right	x	Left	Thru	Right	x	Left	Thru	Right	x	Left	Thru	Right	x			
7 00 AM - 7 15 AM	x	x	x	x	x	x	x	229	x	x	x	x	x	x	x	x	465	x	x
7 15 AM - 7 30 AM	x	x	x	x	x	x	x	204	x	x	x	x	x	x	x	x	387	x	x
7 30 AM - 7 45 AM	x	x	x	x	x	x	x	169	x	x	x	x	x	x	x	x	394	x	x
7 45 AM - 8 00 AM	x	x	x	x	x	x	x	181	x	x	x	x	x	x	x	x	344	x	x
8 00 AM - 8 15 AM	x	x	x	x	x	x	x	185	x	x	x	x	x	x	x	x	382	x	x
8 15 AM - 8 30 AM	x	x	x	x	x	x	x	188	x	x	x	x	x	x	x	x	363	x	x
8 30 AM - 8 45 AM	x	x	x	x	x	x	x	199	x	x	x	x	x	x	x	x	365	x	x
8 45 AM - 9 00 AM	x	x	x	x	x	x	x	182	x	x	x	x	x	x	x	x	386	x	x
TOTAL	x	x	x	x	x	x	x	1537	x	x	x	x	x	x	x	x	3086	x	x

Time	Northbound				Southbound				Eastbound				Westbound						
	Left	Thru	Right	x	Left	Thru	Right	x	Left	Thru	Right	x	Left	Thru	Right	x			
11 00 AM - 11 15 AM	x	x	x	x	x	x	x	185	x	x	x	x	x	x	x	x	403	x	x
11 15 AM - 11 30 AM	x	x	x	x	x	x	x	192	x	x	x	x	x	x	x	x	388	x	x
11 30 AM - 11 45 AM	x	x	x	x	x	x	x	178	x	x	x	x	x	x	x	x	389	x	x
11 45 AM - 12 00 PM	x	x	x	x	x	x	x	168	x	x	x	x	x	x	x	x	384	x	x
12 00 PM - 12 15 PM	x	x	x	x	x	x	x	176	x	x	x	x	x	x	x	x	350	x	x
12 15 PM - 12 30 PM	x	x	x	x	x	x	x	183	x	x	x	x	x	x	x	x	378	x	x
12 30 PM - 12 45 PM	x	x	x	x	x	x	x	179	x	x	x	x	x	x	x	x	403	x	x
12 45 PM - 1 00 PM	x	x	x	x	x	x	x	151	x	x	x	x	x	x	x	x	311	x	x
TOTAL	x	x	x	x	x	x	x	1412	x	x	x	x	x	x	x	x	3006	x	x

Time	Northbound				Southbound				Eastbound				Westbound						
	Left	Thru	Right	x	Left	Thru	Right	x	Left	Thru	Right	x	Left	Thru	Right	x			
4 00 PM - 4 15 PM	x	x	x	x	x	x	x	173	x	x	x	x	x	x	x	x	330	x	x
4 15 PM - 4 30 PM	x	x	x	x	x	x	x	174	x	x	x	x	x	x	x	x	326	x	x
4 30 PM - 4 45 PM	x	x	x	x	x	x	x	145	x	x	x	x	x	x	x	x	335	x	x
4 45 PM - 5 00 PM	x	x	x	x	x	x	x	303	x	x	x	x	x	x	x	x	570	x	x
5 00 PM - 5 15 PM	x	x	x	x	x	x	x	163	x	x	x	x	x	x	x	x	365	x	x
5 15 PM - 5 30 PM	x	x	x	x	x	x	x	160	x	x	x	x	x	x	x	x	280	x	x
5 30 PM - 5 45 PM	x	x	x	x	x	x	x	153	x	x	x	x	x	x	x	x	281	x	x
5 45 PM - 6 00 PM	x	x	x	x	x	x	x	162	x	x	x	x	x	x	x	x	254	x	x
TOTAL	x	x	x	x	x	x	x	1433	x	x	x	x	x	x	x	x	2741	x	x

PEAK HOUR	Northbound				Southbound				Eastbound				Westbound						
	Left	Thru	Right	x	Left	Thru	Right	x	Left	Thru	Right	x	Left	Thru	Right	x			
7 00 AM - 8 00 AM	x	x	x	x	x	x	x	783	x	x	x	x	x	x	x	x	1590	x	x
11 00 AM - 12 00 PM	x	x	x	x	x	x	x	723	x	x	x	x	x	x	x	x	1564	x	x
4 15 PM - 5 15 PM	x	x	x	x	x	x	x	785	x	x	x	x	x	x	x	x	1596	x	x

	PHF
AM	0.855
MID	0.972
PM	0.682

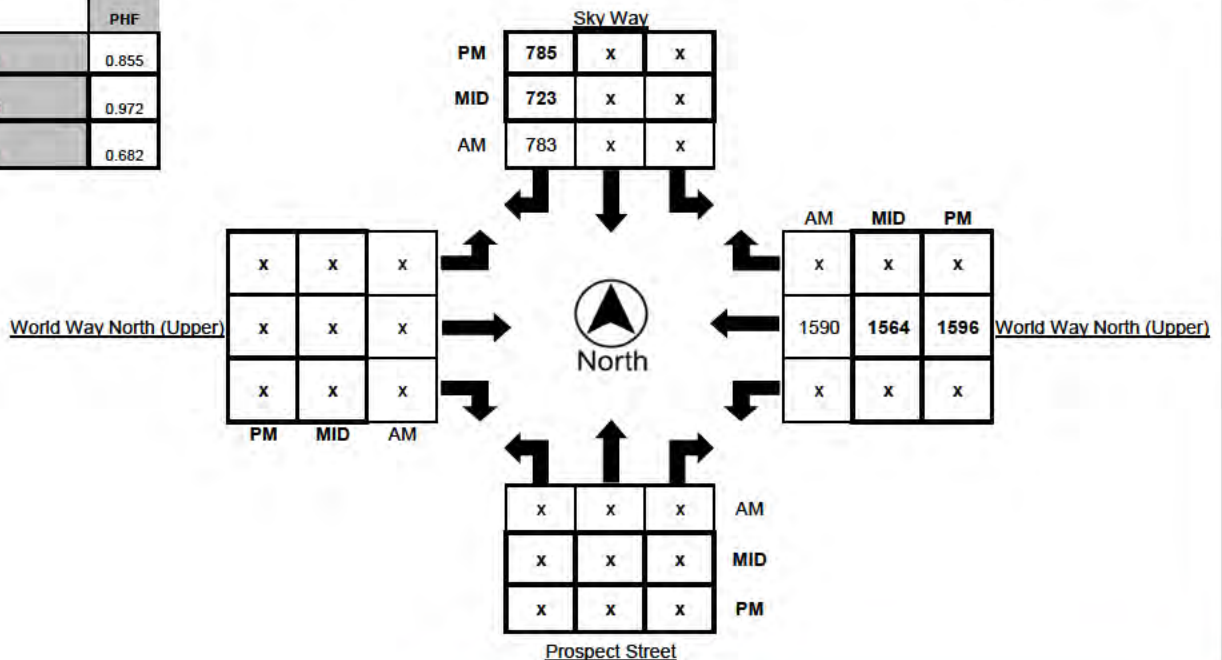



Metro Traffic Data Inc.
 310 N. Irwin Street - Suite 20
 Hanford, CA 93230
 800-975-6938 Phone/Fax
 www.metrotrafficdata.com

Turning Movement Report

Prepared For: Patrick Tomcheck
 Los Angeles World Airports

LOCATION East Way @ World Way South (Upper) LATITUDE 33.943027°
 COUNTY Los Angeles LONGITUDE -118.401474°
 COLLECTION DATE 8/2/2013 WEATHER Sunny and Clear

Time	Northbound				Southbound				Eastbound				Westbound				
	Left	Thru	Right	x	Left	Thru	Right	x	Left	Thru	Right	x	Left	Thru	Right	x	
7 00 AM - 7 15 AM	x	x	x	x	141	x	x	x	x	11	435	x	x	x	x	x	x
7 15 AM - 7 30 AM	x	x	x	x	153	x	x	x	x	12	437	x	x	x	x	x	x
7 30 AM - 7 45 AM	x	x	x	x	112	x	x	x	x	22	491	x	x	x	x	x	x
7 45 AM - 8 00 AM	x	x	x	x	110	x	x	x	x	30	430	x	x	x	x	x	x
8 00 AM - 8 15 AM	x	x	x	x	102	x	x	x	x	22	361	x	x	x	x	x	x
8 15 AM - 8 30 AM	x	x	x	x	111	x	x	x	x	23	374	x	x	x	x	x	x
8 30 AM - 8 45 AM	x	x	x	x	111	x	x	x	x	23	393	x	x	x	x	x	x
8 45 AM - 9 00 AM	x	x	x	x	115	x	x	x	x	23	410	x	x	x	x	x	x
TOTAL	x	x	x	x	955	x	x	x	x	166	3331	x	x	x	x	x	x

Time	Northbound				Southbound				Eastbound				Westbound				
	Left	Thru	Right	x	Left	Thru	Right	x	Left	Thru	Right	x	Left	Thru	Right	x	
11 00 AM - 11 15 AM	x	x	x	x	123	x	x	x	x	29	374	x	x	x	x	x	x
11 15 AM - 11 30 AM	x	x	x	x	138	x	x	x	x	28	342	x	x	x	x	x	x
11 30 AM - 11 45 AM	x	x	x	x	118	x	x	x	x	20	399	x	x	x	x	x	x
11 45 AM - 12 00 PM	x	x	x	x	107	x	x	x	x	16	357	x	x	x	x	x	x
12 00 PM - 12 15 PM	x	x	x	x	90	x	x	x	x	18	360	x	x	x	x	x	x
12 15 PM - 12 30 PM	x	x	x	x	92	x	x	x	x	17	368	x	x	x	x	x	x
12 30 PM - 12 45 PM	x	x	x	x	102	x	x	x	x	21	384	x	x	x	x	x	x
12 45 PM - 1 00 PM	x	x	x	x	73	x	x	x	x	20	369	x	x	x	x	x	x
TOTAL	x	x	x	x	843	x	x	x	x	169	2953	x	x	x	x	x	x

Time	Northbound				Southbound				Eastbound				Westbound				
	Left	Thru	Right	x	Left	Thru	Right	x	Left	Thru	Right	x	Left	Thru	Right	x	
4 00 PM - 4 15 PM	x	x	x	x	100	x	x	x	x	25	344	x	x	x	x	x	x
4 15 PM - 4 30 PM	x	x	x	x	106	x	x	x	x	23	299	x	x	x	x	x	x
4 30 PM - 4 45 PM	x	x	x	x	75	x	x	x	x	32	332	x	x	x	x	x	x
4 45 PM - 5 00 PM	x	x	x	x	89	x	x	x	x	22	320	x	x	x	x	x	x
5 00 PM - 5 15 PM	x	x	x	x	75	x	x	x	x	18	309	x	x	x	x	x	x
5 15 PM - 5 30 PM	x	x	x	x	87	x	x	x	x	21	254	x	x	x	x	x	x
5 30 PM - 5 45 PM	x	x	x	x	96	x	x	x	x	10	264	x	x	x	x	x	x
5 45 PM - 6 00 PM	x	x	x	x	97	x	x	x	x	16	268	x	x	x	x	x	x
TOTAL	x	x	x	x	725	x	x	x	x	167	2390	x	x	x	x	x	x

PEAK HOUR	Northbound				Southbound				Eastbound				Westbound				
	Left	Thru	Right	x	Left	Thru	Right	x	Left	Thru	Right	x	Left	Thru	Right	x	
7 00 AM - 8 00 AM	x	x	x	x	516	x	x	x	x	75	1793	x	x	x	x	x	x
11 00 AM - 12 00 PM	x	x	x	x	486	x	x	x	x	93	1472	x	x	x	x	x	x
4 00 PM - 5 00 PM	x	x	x	x	370	x	x	x	x	102	1295	x	x	x	x	x	x

	PHF
AM	0.954
MID	0.955
PM	0.942

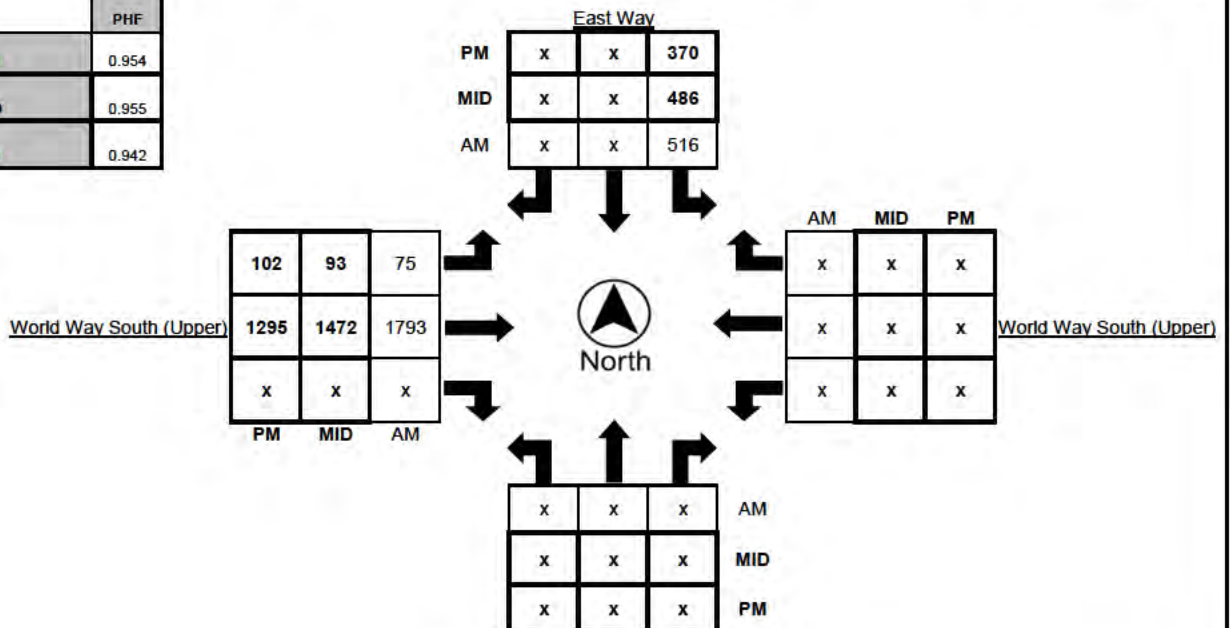



Metro Traffic Data Inc.
 310 N. Irwin Street - Suite 20
 Hanford, CA 93230
 800-975-6938 Phone/Fax
 www.metrotrafficdata.com

Turning Movement Report

Prepared For: Patrick Tomcheck
 Los Angeles World Airports

LOCATION West Way @ World Way South (Upper) LATITUDE 33.942650°
 COUNTY Los Angeles LONGITUDE -118.405349°
 COLLECTION DATE 8/9/2013 WEATHER Sunny and Clear

Time	Northbound				Southbound				Eastbound				Westbound				
	Left	Thru	Right	x	Left	Thru	Right	x	Left	Thru	Right	x	Left	Thru	Right	x	
7 00 AM - 7 15 AM	x	x	x	x	182	x	x	x	x	x	323	x	x	x	x	x	x
7 15 AM - 7 30 AM	x	x	x	x	132	x	x	x	x	x	328	x	x	x	x	x	x
7 30 AM - 7 45 AM	x	x	x	x	133	x	x	x	x	x	246	x	x	x	x	x	x
7 45 AM - 8 00 AM	x	x	x	x	102	x	x	x	x	x	242	x	x	x	x	x	x
8 00 AM - 8 15 AM	x	x	x	x	129	x	x	x	x	x	262	x	x	x	x	x	x
8 15 AM - 8 30 AM	x	x	x	x	100	x	x	x	x	x	223	x	x	x	x	x	x
8 30 AM - 8 45 AM	x	x	x	x	115	x	x	x	x	x	243	x	x	x	x	x	x
8 45 AM - 9 00 AM	x	x	x	x	122	x	x	x	x	x	232	x	x	x	x	x	x
TOTAL	x	x	x	x	1015	x	x	x	x	x	2099	x	x	x	x	x	x

Time	Northbound				Southbound				Eastbound				Westbound				
	Left	Thru	Right	x	Left	Thru	Right	x	Left	Thru	Right	x	Left	Thru	Right	x	
11 00 AM - 11 15 AM	x	x	x	x	115	x	x	x	x	x	264	x	x	x	x	x	x
11 15 AM - 11 30 AM	x	x	x	x	122	x	x	x	x	x	267	x	x	x	x	x	x
11 30 AM - 11 45 AM	x	x	x	x	132	x	x	x	x	x	269	x	x	x	x	x	x
11 45 AM - 12 00 PM	x	x	x	x	151	x	x	x	x	x	288	x	x	x	x	x	x
12 00 PM - 12 15 PM	x	x	x	x	119	x	x	x	x	x	268	x	x	x	x	x	x
12 15 PM - 12 30 PM	x	x	x	x	109	x	x	x	x	x	276	x	x	x	x	x	x
12 30 PM - 12 45 PM	x	x	x	x	84	x	x	x	x	x	289	x	x	x	x	x	x
12 45 PM - 1 00 PM	x	x	x	x	79	x	x	x	x	x	239	x	x	x	x	x	x
TOTAL	x	x	x	x	911	x	x	x	x	x	2160	x	x	x	x	x	x

Time	Northbound				Southbound				Eastbound				Westbound				
	Left	Thru	Right	x	Left	Thru	Right	x	Left	Thru	Right	x	Left	Thru	Right	x	
4 00 PM - 4 15 PM	x	x	x	x	130	x	x	x	x	x	251	x	x	x	x	x	x
4 15 PM - 4 30 PM	x	x	x	x	115	x	x	x	x	x	220	x	x	x	x	x	x
4 30 PM - 4 45 PM	x	x	x	x	104	x	x	x	x	x	238	x	x	x	x	x	x
4 45 PM - 5 00 PM	x	x	x	x	121	x	x	x	x	x	203	x	x	x	x	x	x
5 00 PM - 5 15 PM	x	x	x	x	92	x	x	x	x	x	227	x	x	x	x	x	x
5 15 PM - 5 30 PM	x	x	x	x	87	x	x	x	x	x	195	x	x	x	x	x	x
5 30 PM - 5 45 PM	x	x	x	x	90	x	x	x	x	x	188	x	x	x	x	x	x
5 45 PM - 6 00 PM	x	x	x	x	68	x	x	x	x	x	187	x	x	x	x	x	x
TOTAL	x	x	x	x	807	x	x	x	x	x	1709	x	x	x	x	x	x

PEAK HOUR	Northbound				Southbound				Eastbound				Westbound				
	Left	Thru	Right	x	Left	Thru	Right	x	Left	Thru	Right	x	Left	Thru	Right	x	
7 00 AM - 8 00 AM	x	x	x	x	549	x	x	x	x	x	1139	x	x	x	x	x	x
11 15 AM - 12 15 PM	x	x	x	x	524	x	x	x	x	x	1092	x	x	x	x	x	x
4 00 PM - 5 00 PM	x	x	x	x	470	x	x	x	x	x	912	x	x	x	x	x	x

	PHF
AM	0.836
MID	0.920
PM	0.907

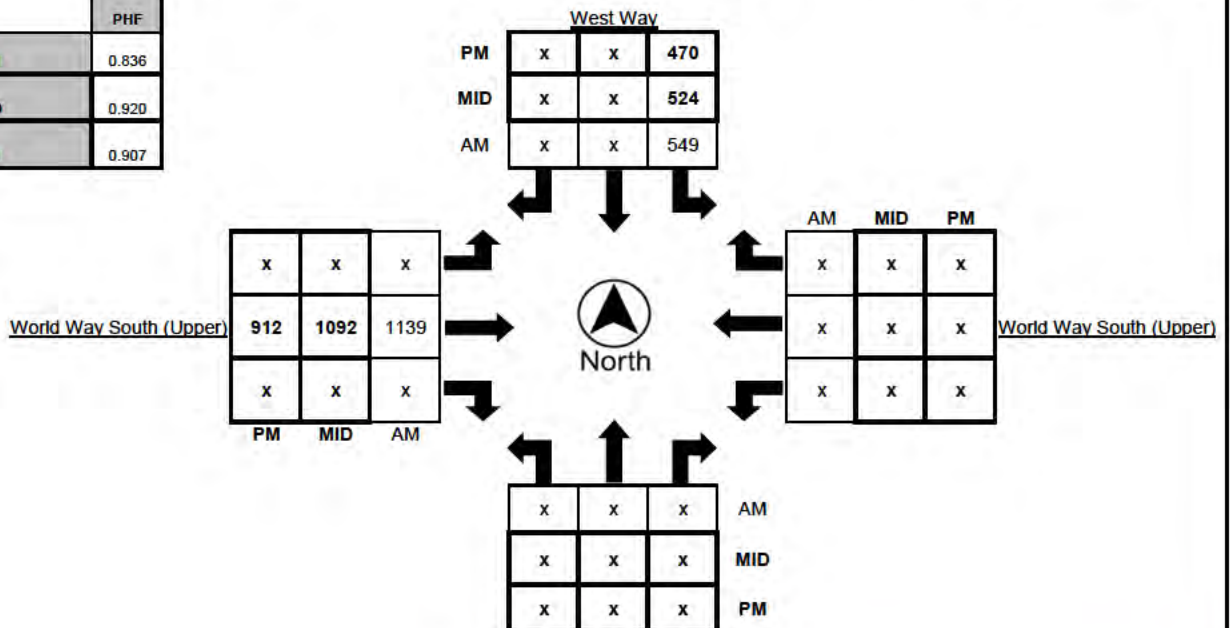

This page intentionally left blank.

ATTACHMENT B

LEVEL OF SERVICE WORKSHEETS – EXISTING (2013) CONDITIONS

This page intentionally left blank.

Level of Service Worksheet (Circular 212 Method)



I/S #:
1

PROJECT TITLE: LAX Terminal 1 Improvement Project
North-South Street: Sky Way **East-West Street:** World Way North (Upper Level)
Scenario: Existing Conditions
Count Date: Year 2013 **Analyst:** **Date:**

		AM PEAK HOUR			PM PEAK HOUR		
		Volume	No. of Lanes	Lane Volume	Volume	No. of Lanes	Lane Volume
No. of Phases Opposed Ø'ing: N/S-1, E/W-2 or Both-3? Right Turns: FREE-1, NRTOR-2 or OLA-3? ATSAC-1 or ATSAC+ATCS-2? Override Capacity				0			0
				0			0
		NB --	SB --	0	NB --	SB --	0
		EB --	WB --	0	EB --	WB --	0
				0			0
				1375			1375
MOVEMENT		Volume	No. of Lanes	Lane Volume	Volume	No. of Lanes	Lane Volume
NORTHBOUND	Left	0	0	0	0	0	0
	Left-Through		0			0	
	Through	0	0	0	0	0	0
	Through-Right		0			0	
	Right	0	0	0	0	0	0
	Left-Through-Right		0			0	
	Left-Right		0			0	
SOUTHBOUND	Left	0	0	0	0	0	0
	Left-Through		0			0	
	Through	0	0	0	0	0	0
	Through-Right		0			0	
	Right	783	3	274	638	3	223
	Left-Through-Right		0			0	
	Left-Right		0			0	
EASTBOUND	Left	0	0	0	0	0	0
	Left-Through		0			0	
	Through	0	0	0	0	0	0
	Through-Right		0			0	
	Right	0	0	0	0	0	0
	Left-Through-Right		0			0	
	Left-Right		0			0	
WESTBOUND	Left	0	0	0	0	0	0
	Left-Through		0			0	
	Through	1590	4	398	1180	4	295
	Through-Right		0			0	
	Right	0	0	0	0	0	0
	Left-Through-Right		0			0	
	Left-Right		0			0	
CRITICAL VOLUMES				<i>North-South:</i> 274			<i>North-South:</i> 223
				<i>East-West:</i> 398			<i>East-West:</i> 295
				SUM: 672			SUM: 518
VOLUME/CAPACITY (V/C) RATIO:				0.489			0.377
V/C LESS ATSAC/ATCS ADJUSTMENT:				0.489			0.377
LEVEL OF SERVICE (LOS):				A			A

Level of Service Worksheet (Circular 212 Method)



I/S #:
2

PROJECT TITLE: LAX Terminal 1 Improvement Project
North-South Street: West Way **East-West Street:** World Way South (Upper Level)
Scenario: Existing Conditions
Count Date: Year 2013 **Analyst:** **Date:**

		AM PEAK HOUR			PM PEAK HOUR		
		Volume	No. of Lanes	Lane Volume	Volume	No. of Lanes	Lane Volume
No. of Phases Opposed Ø'ing: N/S-1, E/W-2 or Both-3? Right Turns: FREE-1, NRTOR-2 or OLA-3? ATSAC-1 or ATSAC+ATCS-2? Override Capacity				0			0
				0			0
		<i>NB</i> -- 0	<i>SB</i> -- 0	0	<i>NB</i> -- 0	<i>SB</i> -- 0	0
		<i>EB</i> -- 0	<i>WB</i> -- 0	0	<i>EB</i> -- 0	<i>WB</i> -- 0	0
				1375			1375
MOVEMENT		Volume	No. of Lanes	Lane Volume	Volume	No. of Lanes	Lane Volume
NORTHBOUND	↵ Left	0	0	0	0	0	0
	↵↔ Left-Through		0			0	
	→ Through	0	0	0	0	0	0
	→↔ Through-Right		0			0	
	↘ Right	0	0	0	0	0	0
	↵↔↘ Left-Through-Right		0			0	
	↵↘ Left-Right		0			0	
SOUTHBOUND	↵ Left	549	2	302	337	2	185
	↵↔ Left-Through		0			0	
	→ Through	0	0	0	0	0	0
	→↔ Through-Right		0			0	
	↘ Right	0	0	0	0	0	0
	↵↔↘ Left-Through-Right		0			0	
	↵↘ Left-Right		0			0	
EASTBOUND	↵ Left	0	0	0	0	0	0
	↵↔ Left-Through		0			0	
	→ Through	1139	3	380	797	3	266
	→↔ Through-Right		0			0	
	↘ Right	0	0	0	0	0	0
	↵↔↘ Left-Through-Right		0			0	
	↵↘ Left-Right		0			0	
WESTBOUND	↵ Left	0	0	0	0	0	0
	↵↔ Left-Through		0			0	
	→ Through	0	0	0	0	0	0
	→↔ Through-Right		0			0	
	↘ Right	0	0	0	0	0	0
	↵↔↘ Left-Through-Right		0			0	
	↵↘ Left-Right		0			0	
CRITICAL VOLUMES				<i>North-South:</i> 302 <i>East-West:</i> 380 <i>SUM:</i> 682			<i>North-South:</i> 185 <i>East-West:</i> 266 <i>SUM:</i> 451
VOLUME/CAPACITY (V/C) RATIO:				0.496			0.328
V/C LESS ATSAC/ATCS ADJUSTMENT:				0.496			0.328
LEVEL OF SERVICE (LOS):				A			A

Level of Service Worksheet (Circular 212 Method)



I/S #:
3

PROJECT TITLE: LAX Terminal 1 Improvement Project
North-South Street: East Way **East-West Street:** World Way South (Upper Level)
Scenario: Existing Conditions
Count Date: Year 2013 **Analyst:** **Date:**

		AM PEAK HOUR			PM PEAK HOUR		
		Volume	No. of Lanes	Lane Volume	Volume	No. of Lanes	Lane Volume
No. of Phases Opposed Ø'ing: N/S-1, E/W-2 or Both-3? Right Turns: FREE-1, NRTOR-2 or OLA-3? ATSAC-1 or ATSAC+ATCS-2? Override Capacity				0			0
				0			0
		<i>NB --</i>		0	<i>NB --</i>		0
		<i>EB --</i>		0	<i>EB --</i>		0
				0			0
				1375			1375
MOVEMENT		Volume	No. of Lanes	Lane Volume	Volume	No. of Lanes	Lane Volume
NORTHBOUND	Left	0	0	0	0	0	0
	Left-Through		0			0	
	Through	0	0	0	0	0	0
	Through-Right		0			0	
	Right	0	0	0	0	0	0
	Left-Through-Right		0			0	
	Left-Right		0			0	
SOUTHBOUND	Left	516	2	284	355	2	195
	Left-Through		0			0	
	Through	0	0	0	0	0	0
	Through-Right		0			0	
	Right	0	0	0	0	0	0
	Left-Through-Right		0			0	
	Left-Right		0			0	
EASTBOUND	Left	75	0	75	65	0	65
	Left-Through		1			1	
	Through	1793	2	623	1095	2	387
	Through-Right		0			0	
	Right	0	0	0	0	0	0
	Left-Through-Right		0			0	
	Left-Right		0			0	
WESTBOUND	Left	0	0	0	0	0	0
	Left-Through		0			0	
	Through	0	0	0	0	0	0
	Through-Right		0			0	
	Right	0	0	0	0	0	0
	Left-Through-Right		0			0	
	Left-Right		0			0	
CRITICAL VOLUMES				<i>North-South:</i> 284 <i>East-West:</i> 623 <i>SUM:</i> 907			<i>North-South:</i> 195 <i>East-West:</i> 387 <i>SUM:</i> 582
VOLUME/CAPACITY (V/C) RATIO:				0.660			0.423
V/C LESS ATSAC/ATCS ADJUSTMENT:				0.660			0.423
LEVEL OF SERVICE (LOS):				B			A

Level of Service Worksheet (Circular 212 Method)



I/S #:
4

PROJECT TITLE: LAX Terminal 1 Improvement Project
North-South Street: Sky Way **East-West Street:** World Way North (Lower Level)
Scenario: Existing Conditions
Count Date: Year 2013 **Analyst:** **Date:**

		AM PEAK HOUR			PM PEAK HOUR		
		Volume	No. of Lanes	Lane Volume	Volume	No. of Lanes	Lane Volume
No. of Phases Opposed Ø'ing: N/S-1, E/W-2 or Both-3? Right Turns: FREE-1, NRTOR-2 or OLA-3? ATSAC-1 or ATSAC+ATCS-2? Override Capacity				0 1 0 0 0 1375			0 1 0 0 0 1375
		<i>NB --</i>	<i>SB --</i>		<i>NB --</i>	<i>SB --</i>	
		<i>EB --</i>	<i>WB --</i>		<i>EB --</i>	<i>WB --</i>	
MOVEMENT		Volume	No. of Lanes	Lane Volume	Volume	No. of Lanes	Lane Volume
NORTHBOUND	Left	306	2	168	310	2	171
	Left-Through		0			0	
	Through	172	1	172	148	1	148
	Through-Right		0			0	
	Right	0	0	0	0	0	0
	Left-Through-Right		0			0	
	Left-Right		0			0	
SOUTHBOUND	Left	0	0	0	0	0	0
	Left-Through		0			0	
	Through	0	0	0	0	0	0
	Through-Right		0			0	
	Right	268	3	94	785	3	275
	Left-Through-Right		0			0	
	Left-Right		0			0	
EASTBOUND	Left	0	0	0	0	0	0
	Left-Through		0			0	
	Through	0	0	0	0	0	0
	Through-Right		0			0	
	Right	0	0	0	0	0	0
	Left-Through-Right		0			0	
	Left-Right		0			0	
WESTBOUND	Left	0	0	0	0	0	0
	Left-Through		0			0	
	Through	677	6	113	1263	6	211
	Through-Right		0			0	
	Right	0	0	0	0	0	0
	Left-Through-Right		0			0	
	Left-Right		0			0	
CRITICAL VOLUMES				<i>North-South:</i> 266 <i>East-West:</i> 113 <i>SUM:</i> 379			<i>North-South:</i> 446 <i>East-West:</i> 211 <i>SUM:</i> 657
VOLUME/CAPACITY (V/C) RATIO:				0.276			0.478
V/C LESS ATSAC/ATCS ADJUSTMENT:				0.276			0.478
LEVEL OF SERVICE (LOS):				A			A

Level of Service Worksheet (Circular 212 Method)



I/S #:
5

PROJECT TITLE: LAX Terminal 1 Improvement Project
North-South Street: West Way **East-West Street:** Center Way
Scenario: Existing Conditions
Count Date: Year 2013 **Analyst:** **Date:**

		AM PEAK HOUR			PM PEAK HOUR		
		Volume	No. of Lanes	Lane Volume	Volume	No. of Lanes	Lane Volume
No. of Phases Opposed Ø'ing: N/S-1, E/W-2 or Both-3? Right Turns: FREE-1, NRTOR-2 or OLA-3? ATSAC-1 or ATSAC+ATCS-2? Override Capacity				0			0
				0			0
		NB --	SB --	0	NB --	SB --	0
		EB --	WB --	0	EB --	WB --	0
				0			0
				1375			1375
MOVEMENT		Volume	No. of Lanes	Lane Volume	Volume	No. of Lanes	Lane Volume
NORTHBOUND	Left	0	0	0	0	0	0
	Left-Through		0			0	
	Through	2	1	2	38	1	38
	Through-Right		0			0	
	Right	0	0	0	0	0	0
	Left-Through-Right		0			0	
	Left-Right		0			0	
SOUTHBOUND	Left	1	0	1	83	0	83
	Left-Through		1			1	
	Through	110	1	56	258	1	171
	Through-Right		0			0	
	Right	0	0	0	0	0	0
	Left-Through-Right		0			0	
	Left-Right		0			0	
EASTBOUND	Left	74	0	74	52	0	52
	Left-Through		1			1	
	Through	1	0	44	417	0	299
	Through-Right		1			1	
	Right	43	0	0	128	0	299
	Left-Through-Right		0			0	
	Left-Right		0			0	
WESTBOUND	Left	0	0	0	0	0	0
	Left-Through		0			0	
	Through	0	0	0	0	0	0
	Through-Right		0			0	
	Right	0	0	0	0	0	0
	Left-Through-Right		0			0	
	Left-Right		0			0	
CRITICAL VOLUMES				<i>North-South:</i> 56			<i>North-South:</i> 171
				<i>East-West:</i> 74			<i>East-West:</i> 299
				SUM: 130			SUM: 470
VOLUME/CAPACITY (V/C) RATIO:				0.095			0.342
V/C LESS ATSAC/ATCS ADJUSTMENT:				0.095			0.342
LEVEL OF SERVICE (LOS):				A			A

Level of Service Worksheet (Circular 212 Method)



I/S #:
6

PROJECT TITLE: LAX Terminal 1 Improvement Project
North-South Street: East Way **East-West Street:** Center Way
Scenario: Existing Conditions
Count Date: Year 2013 **Analyst:** **Date:**

		AM PEAK HOUR			PM PEAK HOUR		
		Volume	No. of Lanes	Lane Volume	Volume	No. of Lanes	Lane Volume
No. of Phases Opposed Ø'ing: N/S-1, E/W-2 or Both-3? Right Turns: FREE-1, NRTOR-2 or OLA-3? ATSAC-1 or ATSAC+ATCS-2? Override Capacity				0			0
				0			0
		<i>NB</i> -- 0	<i>SB</i> -- 0	0	<i>NB</i> -- 0	<i>SB</i> -- 0	0
		<i>EB</i> -- 0	<i>WB</i> -- 0	0	<i>EB</i> -- 0	<i>WB</i> -- 0	0
				0			0
				1375			1375
MOVEMENT		Volume	No. of Lanes	Lane Volume	Volume	No. of Lanes	Lane Volume
NORTHBOUND	Left	0	0	0	0	0	0
	Left-Through		0			0	
	Through	42	2	21	193	2	97
	Through-Right		0			0	
	Right	0	0	0	0	0	0
	Left-Through-Right		0			0	
	Left-Right		0			0	
SOUTHBOUND	Left	40	0	40	25	0	25
	Left-Through		1			1	
	Through	105	1	73	309	1	167
	Through-Right		0			0	
	Right	0	0	0	0	0	0
	Left-Through-Right		0			0	
	Left-Right		0			0	
EASTBOUND	Left	12	0	0	18	0	0
	Left-Through		0			0	
	Through	182	1	91	718	1	359
	Through-Right		1			1	
	Right	0	0	0	0	0	0
	Left-Through-Right		0			0	
	Left-Right		0			0	
WESTBOUND	Left	0	0	0	0	0	0
	Left-Through		0			0	
	Through	0	0	0	0	0	0
	Through-Right		0			0	
	Right	0	0	0	0	0	0
	Left-Through-Right		0			0	
	Left-Right		0			0	
CRITICAL VOLUMES				<i>North-South:</i> 73 <i>East-West:</i> 91 <i>SUM:</i> 164			<i>North-South:</i> 167 <i>East-West:</i> 359 <i>SUM:</i> 526
VOLUME/CAPACITY (V/C) RATIO:				0.119			0.383
V/C LESS ATSAC/ATCS ADJUSTMENT:				0.119			0.383
LEVEL OF SERVICE (LOS):				A			A

Level of Service Worksheet (Circular 212 Method)



I/S #:
7

PROJECT TITLE: LAX Terminal 1 Improvement Project
North-South Street: World Way South **East-West Street:** Center Way
Scenario: Existing Conditions
Count Date: Year 2013 **Analyst:** **Date:**

		AM PEAK HOUR			PM PEAK HOUR		
		Volume	No. of Lanes	Lane Volume	Volume	No. of Lanes	Lane Volume
No. of Phases Opposed Ø'ing: N/S-1, E/W-2 or Both-3? Right Turns: FREE-1, NRTOR-2 or OLA-3? ATSAC-1 or ATSAC+ATCS-2? Override Capacity				0			0
				0			0
		<i>NB</i> -- 0	<i>SB</i> -- 0	0	<i>NB</i> -- 0	<i>SB</i> -- 0	0
		<i>EB</i> -- 2	<i>WB</i> -- 0	0	<i>EB</i> -- 2	<i>WB</i> -- 0	0
				0			0
				1375			1375
MOVEMENT		Volume	No. of Lanes	Lane Volume	Volume	No. of Lanes	Lane Volume
NORTHBOUND	↵ Left	186	1	172	416	1	397
	↵↔ Left-Through		1			1	
	→ Through	470	1	172	1014	1	397
	→↔ Through-Right		1			1	
	↘ Right	203	1	172	557	1	397
	↵↔↘ Left-Through-Right		0			0	
	↵↘ Left-Right		0			0	
SOUTHBOUND	↵ Left	0	0	0	0	0	0
	↵↔ Left-Through		0			0	
	→ Through	0	0	0	0	0	0
	→↔ Through-Right		0			0	
	↘ Right	0	0	0	0	0	0
	↵↔↘ Left-Through-Right		0			0	
	↵↘ Left-Right		0			0	
EASTBOUND	↵ Left	17	0	17	20	0	20
	↵↔ Left-Through		1			1	
	→ Through	595	1	204	895	1	367
	→↔ Through-Right		1			1	
	↘ Right	169	1	169	551	1	367
	↵↔↘ Left-Through-Right		0			0	
	↵↘ Left-Right		0			0	
WESTBOUND	↵ Left	0	0	0	0	0	0
	↵↔ Left-Through		0			0	
	→ Through	0	0	0	0	0	0
	→↔ Through-Right		0			0	
	↘ Right	0	0	0	0	0	0
	↵↔↘ Left-Through-Right		0			0	
	↵↘ Left-Right		0			0	
CRITICAL VOLUMES				<i>North-South:</i> 172 <i>East-West:</i> 204 <i>SUM:</i> 376			<i>North-South:</i> 397 <i>East-West:</i> 367 <i>SUM:</i> 764
VOLUME/CAPACITY (V/C) RATIO:				0.273			0.556
V/C LESS ATSAC/ATCS ADJUSTMENT:				0.273			0.556
LEVEL OF SERVICE (LOS):				A			A

Level of Service Worksheet (Circular 212 Method)



I/S #:
1

PROJECT TITLE: LAX Terminal 1 Improvement Project
North-South Street: Sky Way **East-West Street:** World Way North (Upper Level)
Scenario: Existing Conditions
Count Date: Year 2013 **Analyst:** **Date:**

		MD PEAK HOUR					
				0			0
No. of Phases				0			0
Opposed Ø'ing: N/S-1, E/W-2 or Both-3?				0			0
Right Turns: FREE-1, NRTOR-2 or OLA-3?		NB -- 0	SB -- 0	0	NB -- 0	SB -- 0	0
ATSAC-1 or ATSAC+ATCS-2?		EB -- 0	WB -- 0	0	EB -- 0	WB -- 0	0
Override Capacity				1375			0
MOVEMENT		Volume	No. of Lanes	Lane Volume	Volume	No. of Lanes	Lane Volume
NORTHBOUND	↶ Left	0	0	0		0	0
	↶↷ Left-Through		0			0	
	→ Through	0	0	0		0	
	↷ Through-Right		0			0	
	↷ Right	0	0	0		0	
	↷↶ Left-Through-Right		0			0	
	↷↶ Left-Right		0			0	
SOUTHBOUND	↷ Left	0	0	0		0	0
	↷↶ Left-Through		0			0	
	→ Through	0	0	0		0	0
	↷ Through-Right		0			0	
	↷ Right	723	3	253		0	0
	↷↶ Left-Through-Right		0			0	
	↷↶ Left-Right		0			0	
EASTBOUND	↶ Left	0	0	0		0	0
	↶↷ Left-Through		0			0	
	→ Through	0	0	0		0	0
	↷ Through-Right		0			0	
	↷ Right	0	0	0		0	0
	↷↶ Left-Through-Right		0			0	
	↷↶ Left-Right		0			0	
WESTBOUND	↶ Left	0	0	0		0	0
	↶↷ Left-Through		0			0	
	→ Through	1564	4	391		0	0
	↷ Through-Right		0			0	
	↷ Right	0	0	0		0	0
	↷↶ Left-Through-Right		0			0	
	↷↶ Left-Right		0			0	
CRITICAL VOLUMES				North-South: 253			North-South: 0
				East-West: 391			East-West: 0
				SUM: 644			SUM: 0
VOLUME/CAPACITY (V/C) RATIO:				0.468			0.000
V/C LESS ATSAC/ATCS ADJUSTMENT:				0.468			0.000
LEVEL OF SERVICE (LOS):				A			A

Level of Service Worksheet (Circular 212 Method)



I/S #:
2

PROJECT TITLE: LAX Terminal 1 Improvement Project
North-South Street: West Way **East-West Street:** World Way South (Upper Level)
Scenario: Existing Conditions
Count Date: Year 2013 **Analyst:** **Date:**

		MD PEAK HOUR					
		No. of Phases					
Opposed Ø'ing: N/S-1, E/W-2 or Both-3?				0			
Right Turns: FREE-1, NRTOR-2 or OLA-3?		<i>NB --</i> 0 <i>SB --</i> 0 <i>EB --</i> 0 <i>WB --</i> 0		0		<i>NB --</i> 0 <i>SB --</i> 0 <i>EB --</i> 0 <i>WB --</i> 0	
ATSAC-1 or ATSAC+ATCS-2?				0			
Override Capacity				1375			
MOVEMENT		Volume	No. of Lanes	Lane Volume	Volume	No. of Lanes	Lane Volume
NORTHBOUND	↶ Left	0	0	0		0	0
	↶↷ Left-Through		0			0	
	→ Through	0	0	0		0	
	↷ Through-Right		0			0	
	↷ Right	0	0	0		0	
	↷↶ Left-Through-Right		0			0	
	↷↶ Left-Right		0			0	
SOUTHBOUND	↷ Left	520	2	286		0	0
	↷↶ Left-Through		0			0	
	→ Through	0	0	0		0	0
	↷ Through-Right		0			0	
	↷ Right	0	0	0		0	0
	↷↶ Left-Through-Right		0			0	
	↷↶ Left-Right		0			0	
EASTBOUND	↶ Left	0	0	0		0	0
	↶↷ Left-Through		0			0	
	→ Through	1088	3	363		0	0
	↷ Through-Right		0			0	
	↷ Right	0	0	0		0	0
	↷↶ Left-Through-Right		0			0	
	↷↶ Left-Right		0			0	
WESTBOUND	↶ Left	0	0	0		0	0
	↶↷ Left-Through		0			0	
	→ Through	0	0	0		0	0
	↷ Through-Right		0			0	
	↷ Right	0	0	0		0	0
	↷↶ Left-Through-Right		0			0	
	↷↶ Left-Right		0			0	
CRITICAL VOLUMES				<i>North-South:</i> 286			<i>North-South:</i> 0
				<i>East-West:</i> 363			<i>East-West:</i> 0
				<i>SUM:</i> 649			<i>SUM:</i> 0
VOLUME/CAPACITY (V/C) RATIO:				0.472			0.000
V/C LESS ATSAC/ATCS ADJUSTMENT:				0.472			0.000
LEVEL OF SERVICE (LOS):				A			A

Level of Service Worksheet (Circular 212 Method)



I/S #:
3

PROJECT TITLE: LAX Terminal 1 Improvement Project
North-South Street: East Way **East-West Street:** World Way South (Upper Level)
Scenario: Existing Conditions
Count Date: Year 2013 **Analyst:** **Date:**

		MD PEAK HOUR					
		Volume	No. of Lanes	Lane Volume	Volume	No. of Lanes	Lane Volume
No. of Phases Opposed Ø'ing: N/S-1, E/W-2 or Both-3? Right Turns: FREE-1, NRTOR-2 or OLA-3? ATSAC-1 or ATSAC+ATCS-2? Override Capacity				0			0
				0			0
		<i>NB</i> -- 0	<i>SB</i> -- 0	0	<i>NB</i> -- 0	<i>SB</i> -- 0	0
		<i>EB</i> -- 0	<i>WB</i> -- 0	0	<i>EB</i> -- 0	<i>WB</i> -- 0	0
				0			0
				1375			0
MOVEMENT		Volume	No. of Lanes	Lane Volume	Volume	No. of Lanes	Lane Volume
NORTHBOUND	Left	0	0	0		0	0
	Left-Through		0			0	
	Through	0	0	0		0	0
	Through-Right		0			0	
	Right	0	0	0		0	0
	Left-Through-Right		0			0	
	Left-Right		0			0	
SOUTHBOUND	Left	486	2	267		0	0
	Left-Through		0			0	
	Through	0	0	0		0	0
	Through-Right		0			0	
	Right	0	0	0		0	0
	Left-Through-Right		0			0	
	Left-Right		0			0	
EASTBOUND	Left	0	0	0		0	0
	Left-Through		0			0	
	Through	1472	3	491		0	0
	Through-Right		0			0	
	Right	0	0	0		0	0
	Left-Through-Right		0			0	
	Left-Right		0			0	
WESTBOUND	Left	0	0	0		0	0
	Left-Through		0			0	
	Through	0	0	0		0	0
	Through-Right		0			0	
	Right	0	0	0		0	0
	Left-Through-Right		0			0	
	Left-Right		0			0	
CRITICAL VOLUMES				<i>North-South:</i> 267 <i>East-West:</i> 491 <i>SUM:</i> 758			<i>North-South:</i> 0 <i>East-West:</i> 0 <i>SUM:</i> 0
VOLUME/CAPACITY (V/C) RATIO:				0.551			0.000
V/C LESS ATSAC/ATCS ADJUSTMENT:				0.551			0.000
LEVEL OF SERVICE (LOS):				A			A

Level of Service Worksheet (Circular 212 Method)



I/S #:
4

PROJECT TITLE: LAX Terminal 1 Improvement Project
North-South Street: Sky Way **East-West Street:** World Way North (Lower Level)
Scenario: Existing Conditions
Count Date: Year 2013 **Analyst:** **Date:**

		MD PEAK HOUR					
		Volume	No. of Lanes	Lane Volume	Volume	No. of Lanes	Lane Volume
No. of Phases				0			0
Opposed Ø'ing: N/S-1, E/W-2 or Both-3?				1			0
Right Turns: FREE-1, NRTOR-2 or OLA-3?		NB -- 0	SB -- 0	0	NB -- 0	SB -- 0	0
ATSAC-1 or ATSAC+ATCS-2?		EB -- 0	WB -- 0	0	EB -- 0	WB -- 0	0
Override Capacity				1375			0
MOVEMENT		Volume	No. of Lanes	Lane Volume	Volume	No. of Lanes	Lane Volume
NORTHBOUND	↙ Left	352	2	194		0	0
	↙↔ Left-Through		0			0	
	→ Through	156	1	156		0	0
	↘ Through-Right		0			0	
	↘ Right	0	0	0		0	0
	↙↔ Left-Through-Right		0			0	
	↘↔ Left-Right		0			0	
SOUTHBOUND	↙ Left	0	0	0		0	0
	↙↔ Left-Through		0			0	
	→ Through	0	0	0		0	0
	↘ Through-Right		0			0	
	↘ Right	765	3	268		0	0
	↙↔ Left-Through-Right		0			0	
	↘↔ Left-Right		0			0	
EASTBOUND	↙ Left	0	0	0		0	0
	↙↔ Left-Through		0			0	
	→ Through	0	0	0		0	0
	↘ Through-Right		0			0	
	↘ Right	0	0	0		0	0
	↙↔ Left-Through-Right		0			0	
	↘↔ Left-Right		0			0	
WESTBOUND	↙ Left	0	0	0		0	0
	↙↔ Left-Through		0			0	
	→ Through	1467	6	245		0	0
	↘ Through-Right		0			0	
	↘ Right	0	0	0		0	0
	↙↔ Left-Through-Right		0			0	
	↘↔ Left-Right		0			0	
CRITICAL VOLUMES				<i>North-South:</i> 462			<i>North-South:</i> 0
				<i>East-West:</i> 245			<i>East-West:</i> 0
				<i>SUM:</i> 707			<i>SUM:</i> 0
VOLUME/CAPACITY (V/C) RATIO:				0.514			0.000
V/C LESS ATSAC/ATCS ADJUSTMENT:				0.514			0.000
LEVEL OF SERVICE (LOS):				A			A

Level of Service Worksheet (Circular 212 Method)



I/S #:
5

PROJECT TITLE: LAX Terminal 1 Improvement Project
North-South Street: West Way **East-West Street:** Center Way
Scenario: Existing Conditions
Count Date: Year 2013 **Analyst:** **Date:**

		MD PEAK HOUR					
		Volume	No. of Lanes	Lane Volume	Volume	No. of Lanes	Lane Volume
No. of Phases					0		
Opposed Ø'ing: N/S-1, E/W-2 or Both-3?					0		
Right Turns: FREE-1, NRTOR-2 or OLA-3?		NB -- 0	SB -- 0	0	NB -- 0	SB -- 0	0
ATSAC-1 or ATSAC+ATCS-2?		EB -- 0	WB -- 0	0	EB -- 0	WB -- 0	0
Override Capacity					1375		
MOVEMENT		Volume	No. of Lanes	Lane Volume	Volume	No. of Lanes	Lane Volume
NORTHBOUND	↶ Left	0	0	0		0	0
	↶↷ Left-Through		0			0	
	→ Through	18	1	18		0	0
	↷ Through-Right		0			0	0
	→ Right	0	0	0		0	0
	↷↶ Left-Through-Right		0			0	
	↷↶ Left-Right		0			0	
SOUTHBOUND	↷ Left	76	0	76		0	0
	↷↶ Left-Through		1			0	
	→ Through	324	1	200		0	0
	↶ Through-Right		0			0	0
	→ Right	0	0	0		0	0
	↶↷ Left-Through-Right		0			0	
	↶↷ Left-Right		0			0	
EASTBOUND	↶ Left	20	0	20		0	0
	↶↷ Left-Through		1			0	
	→ Through	400	0	240		0	0
	↷ Through-Right		1			0	0
	→ Right	59	0	240		0	0
	↷↶ Left-Through-Right		0			0	
	↷↶ Left-Right		0			0	
WESTBOUND	↷ Left	0	0	0		0	0
	↷↶ Left-Through		0			0	
	→ Through	0	0	0		0	0
	↶ Through-Right		0			0	0
	→ Right	0	0	0		0	0
	↶↷ Left-Through-Right		0			0	
	↶↷ Left-Right		0			0	
CRITICAL VOLUMES					<i>North-South:</i> 200	<i>North-South:</i> 0	
					<i>East-West:</i> 240	<i>East-West:</i> 0	
					<i>SUM:</i> 440	<i>SUM:</i> 0	
VOLUME/CAPACITY (V/C) RATIO:					0.320	0.000	
V/C LESS ATSAC/ATCS ADJUSTMENT:					0.320	0.000	
LEVEL OF SERVICE (LOS):					A	A	

Level of Service Worksheet (Circular 212 Method)



I/S #:
6

PROJECT TITLE: LAX Terminal 1 Improvement Project
North-South Street: East Way **East-West Street:** Center Way
Scenario: Existing Conditions
Count Date: Year 2013 **Analyst:** **Date:**

		MD PEAK HOUR					
				0			0
No. of Phases				0			0
Opposed Ø'ing: N/S-1, E/W-2 or Both-3?				0			0
Right Turns: FREE-1, NRTOR-2 or OLA-3?		NB -- 0	SB -- 0	0	NB -- 0	SB -- 0	0
ATSAC-1 or ATSAC+ATCS-2?		EB -- 0	WB -- 0	0	EB -- 0	WB -- 0	0
Override Capacity				1375			0
MOVEMENT		Volume	No. of Lanes	Lane Volume	Volume	No. of Lanes	Lane Volume
NORTHBOUND	↵ Left	0	0	0		0	0
	↵↔ Left-Through		0			0	
	→ Through	165	2	83		0	0
	→↔ Through-Right		0			0	
	↘ Right	0	0	0		0	0
	↵↔↔ Left-Through-Right		0			0	
	↵↔ Left-Right		0			0	
SOUTHBOUND	↵ Left	35	0	35		0	0
	↵↔ Left-Through		1			0	
	→ Through	219	1	127		0	0
	→↔ Through-Right		0			0	
	↘ Right	0	0	0		0	0
	↵↔↔ Left-Through-Right		0			0	
	↵↔ Left-Right		0			0	
EASTBOUND	↵ Left	20	0	0		0	0
	↵↔ Left-Through		0			0	
	→ Through	701	1	351		0	0
	→↔ Through-Right		1			0	
	↘ Right	0	0	0		0	0
	↵↔↔ Left-Through-Right		0			0	
	↵↔ Left-Right		0			0	
WESTBOUND	↵ Left	0	0	0		0	0
	↵↔ Left-Through		0			0	
	→ Through	0	0	0		0	0
	→↔ Through-Right		0			0	
	↘ Right	0	0	0		0	0
	↵↔↔ Left-Through-Right		0			0	
	↵↔ Left-Right		0			0	
CRITICAL VOLUMES				North-South: 127			North-South: 0
				East-West: 351			East-West: 0
				SUM: 478			SUM: 0
VOLUME/CAPACITY (V/C) RATIO:				0.348			0.000
V/C LESS ATSAC/ATCS ADJUSTMENT:				0.348			0.000
LEVEL OF SERVICE (LOS):				A			A

Level of Service Worksheet (Circular 212 Method)



I/S #:
7

PROJECT TITLE: LAX Terminal 1 Improvement Project
North-South Street: World Way South **East-West Street:** Center Way
Scenario: Existing Conditions
Count Date: Year 2013 **Analyst:** **Date:**

		MD PEAK HOUR					
		Volume	No. of Lanes	Lane Volume	Volume	No. of Lanes	Lane Volume
No. of Phases Opposed Ø'ing: N/S-1, E/W-2 or Both-3? Right Turns: FREE-1, NRTOR-2 or OLA-3? ATSAC-1 or ATSAC+ATCS-2? Override Capacity				0			0
				0			0
		<i>NB</i> -- 0	<i>SB</i> -- 0	0	<i>NB</i> -- 0	<i>SB</i> -- 0	0
		<i>EB</i> -- 2	<i>WB</i> -- 0	0	<i>EB</i> -- 0	<i>WB</i> -- 0	0
				0			0
				1375			0
MOVEMENT		Volume	No. of Lanes	Lane Volume	Volume	No. of Lanes	Lane Volume
NORTHBOUND	↵ Left	426	1	426		0	0
	↵↔ Left-Through		1			0	
	→ Through	1112	1	445		0	0
	↵→ Through-Right		1			0	
	↵ Right	667	1	0		0	0
	↵↔ Left-Through-Right		0			0	
	↵↔ Left-Right		0			0	
SOUTHBOUND	↵ Left	0	0	0		0	0
	↵↔ Left-Through		0			0	
	→ Through	0	0	0		0	0
	↵→ Through-Right		0			0	
	↵ Right	0	0	0		0	0
	↵↔ Left-Through-Right		0			0	
	↵↔ Left-Right		0			0	
EASTBOUND	↵ Left	26	0	26		0	0
	↵↔ Left-Through		1			0	
	→ Through	904	1	360		0	0
	↵→ Through-Right		1			0	
	↵ Right	510	1	360		0	0
	↵↔ Left-Through-Right		0			0	
	↵↔ Left-Right		0			0	
WESTBOUND	↵ Left	0	0	0		0	0
	↵↔ Left-Through		0			0	
	→ Through	0	0	0		0	0
	↵→ Through-Right		0			0	
	↵ Right	0	0	0		0	0
	↵↔ Left-Through-Right		0			0	
	↵↔ Left-Right		0			0	
CRITICAL VOLUMES				<i>North-South:</i> 445			<i>North-South:</i> 0
				<i>East-West:</i> 360			<i>East-West:</i> 0
				<i>SUM:</i> 805			<i>SUM:</i> 0
VOLUME/CAPACITY (V/C) RATIO:				0.585			0.000
V/C LESS ATSAC/ATCS ADJUSTMENT:				0.585			0.000
LEVEL OF SERVICE (LOS):				A			A

ATTACHMENT C

LEVEL OF SERVICE WORKSHEETS – FUTURE (2017) BASE CONDITIONS

This page intentionally left blank.

Level of Service Worksheet (Circular 212 Method)



I/S #:
1

PROJECT TITLE: LAX Terminal 1 Improvement Project
North-South Street: Sky Way **East-West Street:** World Way North (Upper Level)
Scenario: Future (2017) Base Conditions
Count Date: **Analyst:** **Date:**

		AM PEAK HOUR			PM PEAK HOUR		
		Volume	No. of Lanes	Lane Volume	Volume	No. of Lanes	Lane Volume
No. of Phases Opposed Ø'ing: N/S-1, E/W-2 or Both-3? Right Turns: FREE-1, NRTOR-2 or OLA-3? ATSAC-1 or ATSAC+ATCS-2? Override Capacity				0 0 0 0 0 1375			0 0 0 0 0 1375
NORTHBOUND	↶	0	0	0	0	0	0
	↶→	0	0	0	0	0	0
	→	0	0	0	0	0	0
	→↷	0	0	0	0	0	0
	↷	0	0	0	0	0	0
	↶↷	0	0	0	0	0	0
	↷↶	0	0	0	0	0	0
SOUTHBOUND	↷	0	0	0	0	0	0
	↷↶	0	0	0	0	0	0
	↶	0	0	0	0	0	0
	↶→	843	3	295	686	3	240
	→	0	0	0	0	0	0
	→↷	0	0	0	0	0	0
	↷	0	0	0	0	0	0
EASTBOUND	↶	0	0	0	0	0	0
	↶→	0	0	0	0	0	0
	→	0	0	0	0	0	0
	→↷	0	0	0	0	0	0
	↷	0	0	0	0	0	0
	↶↷	0	0	0	0	0	0
	↷↶	0	0	0	0	0	0
WESTBOUND	↶	0	0	0	0	0	0
	↶→	1711	4	428	1270	4	318
	→	0	0	0	0	0	0
	→↷	0	0	0	0	0	0
	↷	0	0	0	0	0	0
	↶↷	0	0	0	0	0	0
	↷↶	0	0	0	0	0	0
CRITICAL VOLUMES				North-South: 295 East-West: 428 SUM: 723			North-South: 240 East-West: 318 SUM: 558
VOLUME/CAPACITY (V/C) RATIO:				0.526			0.406
V/C LESS ATSAC/ATCS ADJUSTMENT:				0.526			0.406
LEVEL OF SERVICE (LOS):				A			A

Level of Service Worksheet (Circular 212 Method)



I/S #:
2

PROJECT TITLE: LAX Terminal 1 Improvement Project
North-South Street: West Way **East-West Street:** World Way South (Upper Level)
Scenario: Future (2017) Base Conditions
Count Date: **Analyst:** **Date:**

		AM PEAK HOUR			PM PEAK HOUR		
		Volume	No. of Lanes	Lane Volume	Volume	No. of Lanes	Lane Volume
No. of Phases Opposed Ø'ing: N/S-1, E/W-2 or Both-3? Right Turns: FREE-1, NRTOR-2 or OLA-3? ATSAC-1 or ATSAC+ATCS-2? Override Capacity				0			0
				0			0
		<i>NB</i> -- 0	<i>SB</i> -- 0	0	<i>NB</i> -- 0	<i>SB</i> -- 0	0
		<i>EB</i> -- 0	<i>WB</i> -- 0	0	<i>EB</i> -- 0	<i>WB</i> -- 0	0
				0			0
				1375			1375
MOVEMENT		Volume	No. of Lanes	Lane Volume	Volume	No. of Lanes	Lane Volume
NORTHBOUND	Left	0	0	0	0	0	0
	Left-Through		0			0	
	Through	0	0	0	0	0	0
	Through-Right		0			0	
	Right	0	0	0	0	0	0
	Left-Through-Right		0			0	
	Left-Right		0			0	
SOUTHBOUND	Left	591	2	325	363	2	200
	Left-Through		0			0	
	Through	0	0	0	0	0	0
	Through-Right		0			0	
	Right	0	0	0	0	0	0
	Left-Through-Right		0			0	
	Left-Right		0			0	
EASTBOUND	Left	0	0	0	0	0	0
	Left-Through		0			0	
	Through	1226	3	409	858	3	286
	Through-Right		0			0	
	Right	0	0	0	0	0	0
	Left-Through-Right		0			0	
	Left-Right		0			0	
WESTBOUND	Left	0	0	0	0	0	0
	Left-Through		0			0	
	Through	0	0	0	0	0	0
	Through-Right		0			0	
	Right	0	0	0	0	0	0
	Left-Through-Right		0			0	
	Left-Right		0			0	
CRITICAL VOLUMES				<i>North-South:</i> 325			<i>North-South:</i> 200
				<i>East-West:</i> 409			<i>East-West:</i> 286
				<i>SUM:</i> 734			<i>SUM:</i> 486
VOLUME/CAPACITY (V/C) RATIO:				0.534			0.353
V/C LESS ATSAC/ATCS ADJUSTMENT:				0.534			0.353
LEVEL OF SERVICE (LOS):				A			A

Level of Service Worksheet (Circular 212 Method)



I/S #:
3

PROJECT TITLE: LAX Terminal 1 Improvement Project
North-South Street: East Way **East-West Street:** World Way South (Upper Level)
Scenario: Future (2017) Base Conditions
Count Date: **Analyst:** **Date:**

		AM PEAK HOUR			PM PEAK HOUR		
		Volume	No. of Lanes	Lane Volume	Volume	No. of Lanes	Lane Volume
No. of Phases Opposed Ø'ing: N/S-1, E/W-2 or Both-3? Right Turns: FREE-1, NRTOR-2 or OLA-3? ATSAC-1 or ATSAC+ATCS-2? Override Capacity				0			0
				0			0
		<i>NB</i> -- 0		<i>SB</i> -- 0	<i>NB</i> -- 0		<i>SB</i> -- 0
		<i>EB</i> -- 0		<i>WB</i> -- 0	<i>EB</i> -- 0		<i>WB</i> -- 0
				1375			1375
MOVEMENT		Volume	No. of Lanes	Lane Volume	Volume	No. of Lanes	Lane Volume
NORTHBOUND	↶ Left	0	0	0	0	0	0
	↶↷ Left-Through		0			0	
	→ Through	0	0	0	0	0	0
	↷ Through-Right		0			0	
	↷ Right	0	0	0	0	0	0
	↶↷↷ Left-Through-Right		0			0	
	↷↷ Left-Right		0			0	
SOUTHBOUND	↷ Left	555	2	305	382	2	210
	↷↷ Left-Through		0			0	
	→ Through	0	0	0	0	0	0
	↷ Through-Right		0			0	
	↷ Right	0	0	0	0	0	0
	↷↷↷ Left-Through-Right		0			0	
	↷↷↷ Left-Right		0			0	
EASTBOUND	↶ Left	0	0	0	0	0	0
	↶↷ Left-Through		0			0	
	→ Through	1929	3	643	1178	3	393
	↷ Through-Right		0			0	
	↷ Right	0	0	0	0	0	0
	↶↷↷ Left-Through-Right		0			0	
	↷↷ Left-Right		0			0	
WESTBOUND	↶ Left	0	0	0	0	0	0
	↶↷ Left-Through		0			0	
	→ Through	0	0	0	0	0	0
	↷ Through-Right		0			0	
	↷ Right	0	0	0	0	0	0
	↶↷↷ Left-Through-Right		0			0	
	↷↷ Left-Right		0			0	
CRITICAL VOLUMES				<i>North-South:</i> 305			<i>North-South:</i> 210
				<i>East-West:</i> 643			<i>East-West:</i> 393
				<i>SUM:</i> 948			<i>SUM:</i> 603
VOLUME/CAPACITY (V/C) RATIO:				0.689			0.439
V/C LESS ATSAC/ATCS ADJUSTMENT:				0.689			0.439
LEVEL OF SERVICE (LOS):				B			A

Level of Service Worksheet (Circular 212 Method)



I/S #:
4

PROJECT TITLE: LAX Terminal 1 Improvement Project
North-South Street: Sky Way **East-West Street:** World Way North (Lower Level)
Scenario: Future (2017) Base Conditions
Count Date: **Analyst:** **Date:**

		AM PEAK HOUR			PM PEAK HOUR		
		Volume	No. of Lanes	Lane Volume	Volume	No. of Lanes	Lane Volume
No. of Phases Opposed Ø'ing: N/S-1, E/W-2 or Both-3? Right Turns: FREE-1, NRTOR-2 or OLA-3? ATSAC-1 or ATSAC+ATCS-2? Override Capacity				0 1 0 0 0 1375			0 1 0 0 0 1375
		<i>NB --</i>	<i>SB --</i>		<i>NB --</i>	<i>SB --</i>	
		<i>EB --</i>	<i>WB --</i>		<i>EB --</i>	<i>WB --</i>	
MOVEMENT		Volume	No. of Lanes	Lane Volume	Volume	No. of Lanes	Lane Volume
NORTHBOUND	Left	331	2	182	338	2	186
	Left-Through		0			0	
	Through	185	1	185	159	1	159
	Through-Right		0			0	
	Right	0	0	0	0	0	0
	Left-Through-Right		0			0	
	Left-Right		0			0	
SOUTHBOUND	Left	0	0	0	0	0	0
	Left-Through		0			0	
	Through	0	0	0	0	0	0
	Through-Right		0			0	
	Right	288	3	101	845	3	296
	Left-Through-Right		0			0	
	Left-Right		0			0	
EASTBOUND	Left	0	0	0	0	0	0
	Left-Through		0			0	
	Through	0	0	0	0	0	0
	Through-Right		0			0	
	Right	0	0	0	0	0	0
	Left-Through-Right		0			0	
	Left-Right		0			0	
WESTBOUND	Left	0	0	0	0	0	0
	Left-Through		0			0	
	Through	728	6	121	1359	6	227
	Through-Right		0			0	
	Right	0	0	0	0	0	0
	Left-Through-Right		0			0	
	Left-Right		0			0	
CRITICAL VOLUMES				<i>North-South:</i> 286 <i>East-West:</i> 121 <i>SUM:</i> 407			<i>North-South:</i> 482 <i>East-West:</i> 227 <i>SUM:</i> 709
VOLUME/CAPACITY (V/C) RATIO:				0.296			0.516
V/C LESS ATSAC/ATCS ADJUSTMENT:				0.296			0.516
LEVEL OF SERVICE (LOS):				A			A

Level of Service Worksheet (Circular 212 Method)



I/S #:
5

PROJECT TITLE: LAX Terminal 1 Improvement Project
North-South Street: West Way **East-West Street:** Center Way
Scenario: Future (2017) Base Conditions
Count Date: **Analyst:** **Date:**

		AM PEAK HOUR			PM PEAK HOUR		
		Volume	No. of Lanes	Lane Volume	Volume	No. of Lanes	Lane Volume
No. of Phases Opposed Ø'ing: N/S-1, E/W-2 or Both-3? Right Turns: FREE-1, NRTOR-2 or OLA-3? ATSAC-1 or ATSAC+ATCS-2? Override Capacity		0 0 0 0 1375			0 0 0 0 1375		
		<i>NB --</i> 0 <i>SB --</i> 0 <i>EB --</i> 0 <i>WB --</i> 0			<i>NB --</i> 0 <i>SB --</i> 0 <i>EB --</i> 0 <i>WB --</i> 0		
MOVEMENT		Volume	No. of Lanes	Lane Volume	Volume	No. of Lanes	Lane Volume
NORTHBOUND	Left	0	0	0	0	0	0
	Left-Through		0			0	
	Through	2	1	2	41	1	41
	Through-Right		0			0	
	Right	0	0	0	0	0	0
	Left-Through-Right		0			0	
	Left-Right		0			0	
SOUTHBOUND	Left	1	0	1	89	0	89
	Left-Through		1			1	
	Through	118	1	60	278	1	184
	Through-Right		0			0	
	Right	0	0	0	0	0	0
	Left-Through-Right		0			0	
	Left-Right		0			0	
EASTBOUND [1]	Left	80	0	80	56	0	56
	Left-Through		1			1	
	Through	24	1	24	305	1	181
	Through-Right		0			0	
	Right	0	0	0	0	0	0
	Left-Through-Right		0			0	
	Left-Right		0			0	
WESTBOUND	Left	0	0	0	0	0	0
	Left-Through		0			0	
	Through	0	0	0	0	0	0
	Through-Right		0			0	
	Right	0	0	0	0	0	0
	Left-Through-Right		0			0	
	Left-Right		0			0	
CRITICAL VOLUMES		<i>North-South:</i> 60 <i>East-West:</i> 80 SUM: 140			<i>North-South:</i> 184 <i>East-West:</i> 181 SUM: 365		
VOLUME/CAPACITY (V/C) RATIO:		0.102			0.265		
V/C LESS ATSAC/ATCS ADJUSTMENT:		0.102			0.265		
LEVEL OF SERVICE (LOS):		A			A		

[1] Worst case approach.

Level of Service Worksheet (Circular 212 Method)



I/S #:
6

PROJECT TITLE: LAX Terminal 1 Improvement Project
North-South Street: East Way **East-West Street:** Center Way
Scenario: Future (2017) Base Conditions
Count Date: **Analyst:** **Date:**

		AM PEAK HOUR			PM PEAK HOUR		
		Volume	No. of Lanes	Lane Volume	Volume	No. of Lanes	Lane Volume
No. of Phases Opposed Ø'ing: N/S-1, E/W-2 or Both-3? Right Turns: FREE-1, NRTOR-2 or OLA-3? ATSAC-1 or ATSAC+ATCS-2? Override Capacity				0			0
				0			0
		NB --	SB --	0	NB --	SB --	0
		EB --	WB --	0	EB --	WB --	0
				0			0
				1375			1375
MOVEMENT		Volume	No. of Lanes	Lane Volume	Volume	No. of Lanes	Lane Volume
NORTHBOUND	↵ Left	0	0	0	0	0	0
	↵↔ Left-Through		0			0	
	→ Through	45	2	23	208	2	104
	→↔ Through-Right		0			0	
	↘ Right	0	0	0	0	0	0
	↵↔↔ Left-Through-Right		0			0	
	↵↔↔ Left-Right		0			0	
SOUTHBOUND	↵ Left	43	0	43	27	0	27
	↵↔ Left-Through		1			1	
	→ Through	113	1	78	332	1	180
	→↔ Through-Right		0			0	
	↘ Right	0	0	0	0	0	0
	↵↔↔ Left-Through-Right		0			0	
	↵↔↔ Left-Right		0			0	
EASTBOUND [1]	↵ Left	0	0	0	19	0	19
	↵↔ Left-Through		0			1	
	→ Through	124	1	124	845	2	288
	→↔ Through-Right		0			0	
	↘ Right	0	0	0	0	0	0
	↵↔↔ Left-Through-Right		0			0	
	↵↔↔ Left-Right		0			0	
WESTBOUND	↵ Left	0	0	0	0	0	0
	↵↔ Left-Through		0			0	
	→ Through	0	0	0	0	0	0
	→↔ Through-Right		0			0	
	↘ Right	0	0	0	0	0	0
	↵↔↔ Left-Through-Right		0			0	
	↵↔↔ Left-Right		0			0	
CRITICAL VOLUMES				<i>North-South:</i> 78			<i>North-South:</i> 180
				<i>East-West:</i> 124			<i>East-West:</i> 288
				SUM: 202			SUM: 468
VOLUME/CAPACITY (V/C) RATIO:				0.147			0.340
V/C LESS ATSAC/ATCS ADJUSTMENT:				0.147			0.340
LEVEL OF SERVICE (LOS):				A			A

[1] Worst case approach.

Level of Service Worksheet (Circular 212 Method)



I/S #:
1

PROJECT TITLE: LAX Terminal 1 Improvement Project
North-South Street: Sky Way **East-West Street:** World Way North (Upper Level)
Scenario: Future (2017) Base Conditions
Count Date: Year 2013 **Analyst:** **Date:**

		MD PEAK HOUR					
				0			0
No. of Phases				0			0
Opposed Ø'ing: N/S-1, E/W-2 or Both-3?				0			0
Right Turns: FREE-1, NRTOR-2 or OLA-3?		NB -- 0	SB -- 0	0	NB -- 0	SB -- 0	0
ATSAC-1 or ATSAC+ATCS-2?		EB -- 0	WB -- 0	0	EB -- 0	WB -- 0	0
Override Capacity				1375			0
MOVEMENT		Volume	No. of Lanes	Lane Volume	Volume	No. of Lanes	Lane Volume
NORTHBOUND	↶ Left	0	0	0		0	0
	↶↷ Left-Through		0			0	
	→ Through	0	0	0		0	
	↷ Through-Right		0			0	
	→ Right	0	0	0		0	
	↷↶ Left-Through-Right		0			0	
	↷↶ Left-Right		0			0	
SOUTHBOUND	↷ Left	0	0	0		0	0
	↷↶ Left-Through		0			0	
	→ Through	0	0	0		0	
	↶ Through-Right		0			0	
	→ Right	778	3	272		0	
	↶↷ Left-Through-Right		0			0	
	↶↷ Left-Right		0			0	
EASTBOUND	↶ Left	0	0	0		0	0
	↶↷ Left-Through		0			0	
	→ Through	0	0	0		0	
	↷ Through-Right		0			0	
	→ Right	0	0	0		0	
	↷↶ Left-Through-Right		0			0	
	↷↶ Left-Right		0			0	
WESTBOUND	↶ Left	0	0	0		0	0
	↶↷ Left-Through		0			0	
	→ Through	1683	4	421		0	
	↷ Through-Right		0			0	
	→ Right	0	0	0		0	
	↷↶ Left-Through-Right		0			0	
	↷↶ Left-Right		0			0	
CRITICAL VOLUMES				North-South: 272			North-South: 0
				East-West: 421			East-West: 0
				SUM: 693			SUM: 0
VOLUME/CAPACITY (V/C) RATIO:				0.504			0.000
V/C LESS ATSAC/ATCS ADJUSTMENT:				0.504			0.000
LEVEL OF SERVICE (LOS):				A			A

Level of Service Worksheet (Circular 212 Method)



I/S #:
2

PROJECT TITLE: LAX Terminal 1 Improvement Project
North-South Street: West Way **East-West Street:** World Way South (Upper Level)
Scenario: Future (2017) Base Conditions
Count Date: Year 2013 **Analyst:** **Date:**

		MD PEAK HOUR					
				0			0
No. of Phases				0			0
Opposed Ø'ing: N/S-1, E/W-2 or Both-3?				0			0
Right Turns: FREE-1, NRTOR-2 or OLA-3?		<i>NB --</i> 0	<i>SB --</i> 0	0	<i>NB --</i> 0	<i>SB --</i> 0	0
ATSAC-1 or ATSAC+ATCS-2?		<i>EB --</i> 0	<i>WB --</i> 0	0	<i>EB --</i> 0	<i>WB --</i> 0	0
Override Capacity				1375			0
MOVEMENT		Volume	No. of Lanes	Lane Volume	Volume	No. of Lanes	Lane Volume
NORTHBOUND	↶ Left	0	0	0		0	0
	↶↷ Left-Through		0	0		0	0
	→ Through	0	0	0		0	0
	↷ Through-Right		0	0		0	0
	↷ Right	0	0	0		0	0
	↷↶ Left-Through-Right		0	0		0	0
	↷↶ Left-Right		0	0		0	0
SOUTHBOUND	↷ Left	560	2	308		0	0
	↷↶ Left-Through		0	0		0	0
	→ Through	0	0	0		0	0
	↶ Through-Right		0	0		0	0
	↶ Right	0	0	0		0	0
	↶↷ Left-Through-Right		0	0		0	0
	↶↷ Left-Right		0	0		0	0
EASTBOUND	↶ Left	0	0	0		0	0
	↶↷ Left-Through		0	0		0	0
	→ Through	1171	3	390		0	0
	↷ Through-Right		0	0		0	0
	↷ Right	0	0	0		0	0
	↷↶ Left-Through-Right		0	0		0	0
	↷↶ Left-Right		0	0		0	0
WESTBOUND	↶ Left	0	0	0		0	0
	↶↷ Left-Through		0	0		0	0
	→ Through	0	0	0		0	0
	↷ Through-Right		0	0		0	0
	↷ Right	0	0	0		0	0
	↷↶ Left-Through-Right		0	0		0	0
	↷↶ Left-Right		0	0		0	0
CRITICAL VOLUMES				<i>North-South:</i> 308			<i>North-South:</i> 0
				<i>East-West:</i> 390			<i>East-West:</i> 0
				<i>SUM:</i> 698			<i>SUM:</i> 0
VOLUME/CAPACITY (V/C) RATIO:				0.508			0.000
V/C LESS ATSAC/ATCS ADJUSTMENT:				0.508			0.000
LEVEL OF SERVICE (LOS):				A			A

Level of Service Worksheet (Circular 212 Method)



I/S #:
3

PROJECT TITLE: LAX Terminal 1 Improvement Project
North-South Street: East Way **East-West Street:** World Way South (Upper Level)
Scenario: Future (2017) Base Conditions
Count Date: Year 2013 **Analyst:** **Date:**

		MD PEAK HOUR					
		0	0	0	0	0	0
No. of Phases							
Opposed Ø'ing: N/S-1, E/W-2 or Both-3?							
Right Turns: FREE-1, NRTOR-2 or OLA-3?		NB -- 0	SB -- 0	0	NB -- 0	SB -- 0	0
ATSAC-1 or ATSAC+ATCS-2?		EB -- 0	WB -- 0	0	EB -- 0	WB -- 0	0
Override Capacity		1375					
MOVEMENT		Volume	No. of Lanes	Lane Volume	Volume	No. of Lanes	Lane Volume
NORTHBOUND	↶ Left	0	0	0		0	0
	↶↷ Left-Through		0			0	
	→ Through	0	0	0		0	
	↷ Through-Right		0			0	
	↷ Right	0	0	0		0	
	↷↶ Left-Through-Right		0			0	
	↷↶ Left-Right		0			0	
SOUTHBOUND	↷ Left	523	2	288		0	0
	↷↶ Left-Through		0			0	
	→ Through	0	0	0		0	0
	↷ Through-Right		0			0	
	↷ Right	0	0	0		0	0
	↷↶ Left-Through-Right		0			0	
	↷↶ Left-Right		0			0	
EASTBOUND	↶ Left	0	0	0		0	0
	↶↷ Left-Through		0			0	
	→ Through	1584	3	528		0	0
	↷ Through-Right		0			0	
	↷ Right	0	0	0		0	0
	↷↶ Left-Through-Right		0			0	
	↷↶ Left-Right		0			0	
WESTBOUND	↶ Left	0	0	0		0	0
	↶↷ Left-Through		0			0	
	→ Through	0	0	0		0	0
	↷ Through-Right		0			0	
	↷ Right	0	0	0		0	0
	↷↶ Left-Through-Right		0			0	
	↷↶ Left-Right		0			0	
CRITICAL VOLUMES		<i>North-South:</i>		288	<i>North-South:</i>		0
		<i>East-West:</i>		528	<i>East-West:</i>		0
		<i>SUM:</i>		816	<i>SUM:</i>		0
VOLUME/CAPACITY (V/C) RATIO:				0.593			0.000
V/C LESS ATSAC/ATCS ADJUSTMENT:				0.593			0.000
LEVEL OF SERVICE (LOS):				A			A

Level of Service Worksheet (Circular 212 Method)



I/S #:
4

PROJECT TITLE: LAX Terminal 1 Improvement Project
North-South Street: Sky Way **East-West Street:** World Way North (Lower Level)
Scenario: Future (2017) Base Conditions
Count Date: Year 2013 **Analyst:** **Date:**

		MD PEAK HOUR					
				0			0
No. of Phases				1			0
Opposed Ø'ing: N/S-1, E/W-2 or Both-3?				0			0
Right Turns: FREE-1, NRTOR-2 or OLA-3?		NB -- 0	SB -- 0	0	NB -- 0	SB -- 0	0
ATSAC-1 or ATSAC+ATCS-2?		EB -- 0	WB -- 0	0	EB -- 0	WB -- 0	0
Override Capacity				1375			0
MOVEMENT		Volume	No. of Lanes	Lane Volume	Volume	No. of Lanes	Lane Volume
NORTHBOUND	↶ Left	380	2	209		0	0
	↶↷ Left-Through		0			0	
	→ Through	168	1	168		0	0
	↷ Through-Right		0			0	
	→ Right	0	0	0		0	0
	↷↶ Left-Through-Right		0			0	
	↷ Left-Right		0			0	
SOUTHBOUND	↷ Left	0	0	0		0	0
	↷↶ Left-Through		0			0	
	→ Through	0	0	0		0	0
	↶ Through-Right		0			0	
	→ Right	823	3	288		0	0
	↶↷ Left-Through-Right		0			0	
	↶ Left-Right		0			0	
EASTBOUND	↶ Left	0	0	0		0	0
	↶↷ Left-Through		0			0	
	→ Through	0	0	0		0	0
	↷ Through-Right		0			0	
	→ Right	0	0	0		0	0
	↷↶ Left-Through-Right		0			0	
	↷ Left-Right		0			0	
WESTBOUND	↶ Left	0	0	0		0	0
	↶↷ Left-Through		0			0	
	→ Through	1578	6	263		0	0
	↷ Through-Right		0			0	
	→ Right	0	0	0		0	0
	↷↶ Left-Through-Right		0			0	
	↷ Left-Right		0			0	
CRITICAL VOLUMES				North-South: 497			North-South: 0
				East-West: 263			East-West: 0
				SUM: 760			SUM: 0
VOLUME/CAPACITY (V/C) RATIO:				0.553			0.000
V/C LESS ATSAC/ATCS ADJUSTMENT:				0.553			0.000
LEVEL OF SERVICE (LOS):				A			A

Level of Service Worksheet (Circular 212 Method)



I/S #:
5

PROJECT TITLE: LAX Terminal 1 Improvement Project
North-South Street: West Way **East-West Street:** Center Way
Scenario: Future (2017) Base Conditions
Count Date: Year 2013 **Analyst:** **Date:**

		MD PEAK HOUR					
				0			0
No. of Phases				0			0
Opposed Ø'ing: N/S-1, E/W-2 or Both-3?				0			0
Right Turns: FREE-1, NRTOR-2 or OLA-3?		NB -- 0	SB -- 0	0	NB -- 0	SB -- 0	0
ATSAC-1 or ATSAC+ATCS-2?		EB -- 0	WB -- 0	0	EB -- 0	WB -- 0	0
Override Capacity				1375			0
MOVEMENT		Volume	No. of Lanes	Lane Volume	Volume	No. of Lanes	Lane Volume
NORTHBOUND	↶ Left	0	0	0		0	0
	↶↷ Left-Through		0			0	
	→ Through	19	1	19		0	0
	↷ Through-Right		0			0	0
	↷ Right	0	0	0		0	0
	↷↶ Left-Through-Right		0			0	
	↷↶ Left-Right		0			0	
SOUTHBOUND	↷ Left	82	0	82		0	0
	↷↶ Left-Through		1			0	
	→ Through	349	1	216		0	0
	↶ Through-Right		0			0	0
	↶ Right	0	0	0		0	0
	↶↷ Left-Through-Right		0			0	
	↶↷ Left-Right		0			0	
EASTBOUND [1]	↶ Left	22	0	22		0	0
	↶↶ Left-Through		1			0	
	→ Through	257	1	140		0	0
	↷ Through-Right		0			0	0
	↷ Right	0	0	0		0	0
	↷↶ Left-Through-Right		0			0	
	↷↶ Left-Right		0			0	
WESTBOUND	↶ Left	0	0	0		0	0
	↶↶ Left-Through		0			0	
	→ Through	0	0	0		0	0
	↷ Through-Right		0			0	0
	↷ Right	0	0	0		0	0
	↷↶ Left-Through-Right		0			0	
	↷↶ Left-Right		0			0	
CRITICAL VOLUMES				North-South: 216			North-South: 0
				East-West: 140			East-West: 0
				SUM: 356			SUM: 0
VOLUME/CAPACITY (V/C) RATIO:				0.259			0.000
V/C LESS ATSAC/ATCS ADJUSTMENT:				0.259			0.000
LEVEL OF SERVICE (LOS):				A			A

[1] Worst case approach.

Level of Service Worksheet (Circular 212 Method)



I/S #:
6

PROJECT TITLE: LAX Terminal 1 Improvement Project
North-South Street: East Way **East-West Street:** Center Way
Scenario: Future (2017) Base Conditions
Count Date: Year 2013 **Analyst:** **Date:**

		MD PEAK HOUR					
				0			0
No. of Phases				0			0
Opposed Ø'ing: N/S-1, E/W-2 or Both-3?				0			0
Right Turns: FREE-1, NRTOR-2 or OLA-3?		NB -- 0	SB -- 0	0	NB -- 0	SB -- 0	0
ATSAC-1 or ATSAC+ATCS-2?		EB -- 0	WB -- 0	0	EB -- 0	WB -- 0	0
Override Capacity				1375			0
MOVEMENT		Volume	No. of Lanes	Lane Volume	Volume	No. of Lanes	Lane Volume
NORTHBOUND	↶ Left	0	0	0		0	0
	↶↷ Left-Through		0			0	
	→ Through	178	2	89		0	0
	↷ Through-Right		0			0	
	↷ Right	0	0	0		0	0
	↷↶ Left-Through-Right		0			0	
	↷↶ Left-Right		0			0	
SOUTHBOUND	↷ Left	38	0	38		0	0
	↷↶ Left-Through		1			0	
	→ Through	236	1	137		0	0
	↷ Through-Right		0			0	
	↷ Right	0	0	0		0	0
	↷↶ Left-Through-Right		0			0	
	↷↶ Left-Right		0			0	
EASTBOUND	↶ Left	22	0	0		0	0
	↶↷ Left-Through		0			0	
	→ Through	787	1	394		0	0
	↷ Through-Right		1			0	
	↷ Right	0	0	0		0	0
	↷↶ Left-Through-Right		0			0	
	↷↶ Left-Right		0			0	
WESTBOUND	↷ Left	0	0	0		0	0
	↷↶ Left-Through		0			0	
	→ Through	0	0	0		0	0
	↷ Through-Right		0			0	
	↷ Right	0	0	0		0	0
	↷↶ Left-Through-Right		0			0	
	↷↶ Left-Right		0			0	
CRITICAL VOLUMES				North-South: 137			North-South: 0
				East-West: 394			East-West: 0
				SUM: 531			SUM: 0
VOLUME/CAPACITY (V/C) RATIO:				0.386			0.000
V/C LESS ATSAC/ATCS ADJUSTMENT:				0.386			0.000
LEVEL OF SERVICE (LOS):				A			A

Level of Service Worksheet (Circular 212 Method)



I/S #:
7

PROJECT TITLE: LAX Terminal 1 Improvement Project
North-South Street: World Way South **East-West Street:** Center Way
Scenario: Future (2017) Base Conditions
Count Date: Year 2013 **Analyst:** **Date:**

		MD PEAK HOUR					
				0			0
No. of Phases				0			0
Opposed Ø'ing: N/S-1, E/W-2 or Both-3?				0			0
Right Turns: FREE-1, NRTOR-2 or OLA-3?		NB -- 0	SB -- 0	0	NB -- 0	SB -- 0	0
ATSAC-1 or ATSAC+ATCS-2?		EB -- 2	WB -- 0	0	EB -- 0	WB -- 0	0
Override Capacity				1375			0
MOVEMENT		Volume	No. of Lanes	Lane Volume	Volume	No. of Lanes	Lane Volume
NORTHBOUND	↶ Left	458	1	409		0	0
	↶↷ Left-Through		1			0	
	↷ Through	1178	2	409		0	0
	↷↶ Through-Right		0			0	
	↷ Right	707	2	389		0	0
	↷↶↷ Left-Through-Right		0			0	
	↷↶ Left-Right		0			0	
SOUTHBOUND	↷ Left	0	0	0		0	0
	↷↶ Left-Through		0			0	
	↷ Through	0	0	0		0	0
	↷↶ Through-Right		0			0	
	↷ Right	0	0	0		0	0
	↷↶↷ Left-Through-Right		0			0	
	↷↶ Left-Right		0			0	
EASTBOUND	↶ Left	28	0	28		0	0
	↶↷ Left-Through		1			0	
	↶ Through	1013	1	403		0	0
	↶↷ Through-Right		1			0	
	↶ Right	572	1	403		0	0
	↶↷↶ Left-Through-Right		0			0	
	↶↷ Left-Right		0			0	
WESTBOUND	↷ Left	0	0	0		0	0
	↷↶ Left-Through		0			0	
	↷ Through	0	0	0		0	0
	↷↶ Through-Right		0			0	
	↷ Right	0	0	0		0	0
	↷↶↷ Left-Through-Right		0			0	
	↷↶ Left-Right		0			0	
CRITICAL VOLUMES				North-South: 409			North-South: 0
				East-West: 403			East-West: 0
				SUM: 812			SUM: 0
VOLUME/CAPACITY (V/C) RATIO:				0.591			0.000
V/C LESS ATSAC/ATCS ADJUSTMENT:				0.591			0.000
LEVEL OF SERVICE (LOS):				A			A

This page intentionally left blank.

ATTACHMENT D

LEVEL OF SERVICE WORKSHEETS – FUTURE (2017) WITH PROJECT CONDITIONS

This page intentionally left blank.

Level of Service Worksheet (Circular 212 Method)



I/S #:
1

PROJECT TITLE: LAX Terminal 1 Improvement Project
North-South Street: Sky Way **East-West Street:** World Way North (Upper Level)
Scenario: Future (2017) with Project Conditions
Count Date: **Analyst:** **Date:**

		AM PEAK HOUR			PM PEAK HOUR		
		Volume	No. of Lanes	Lane Volume	Volume	No. of Lanes	Lane Volume
No. of Phases Opposed Ø'ing: N/S-1, E/W-2 or Both-3? Right Turns: FREE-1, NRTOR-2 or OLA-3? ATSAC-1 or ATSAC+ATCS-2? Override Capacity				0 0 0 0 1375			0 0 0 0 1375
		<i>NB --</i>	<i>SB --</i>		<i>NB --</i>	<i>SB --</i>	
		<i>EB --</i>	<i>WB --</i>		<i>EB --</i>	<i>WB --</i>	
MOVEMENT		Volume	No. of Lanes	Lane Volume	Volume	No. of Lanes	Lane Volume
NORTHBOUND	Left	0	0	0	0	0	0
	Left-Through		0			0	
	Through	0	0	0	0	0	0
	Through-Right		0			0	
	Right	0	0	0	0	0	0
	Left-Through-Right		0			0	
	Left-Right		0			0	
SOUTHBOUND	Left	0	0	0	0	0	0
	Left-Through		0			0	
	Through	0	0	0	0	0	0
	Through-Right		0			0	
	Right	843	3	295	686	3	240
	Left-Through-Right		0			0	
	Left-Right		0			0	
EASTBOUND	Left	0	0	0	0	0	0
	Left-Through		0			0	
	Through	0	0	0	0	0	0
	Through-Right		0			0	
	Right	0	0	0	0	0	0
	Left-Through-Right		0			0	
	Left-Right		0			0	
WESTBOUND	Left	0	0	0	0	0	0
	Left-Through		0			0	
	Through	1711	4	428	1270	4	318
	Through-Right		0			0	
	Right	0	0	0	0	0	0
	Left-Through-Right		0			0	
	Left-Right		0			0	
CRITICAL VOLUMES				<i>North-South:</i> <i>East-West:</i> <i>SUM:</i>	295 428 723		<i>North-South:</i> <i>East-West:</i> <i>SUM:</i>
					240 318 558		
VOLUME/CAPACITY (V/C) RATIO:				0.526			0.406
V/C LESS ATSAC/ATCS ADJUSTMENT:				0.526			0.406
LEVEL OF SERVICE (LOS):				A			A

Level of Service Worksheet (Circular 212 Method)



I/S #:
2

PROJECT TITLE: LAX Terminal 1 Improvement Project
North-South Street: West Way **East-West Street:** World Way South (Upper Level)
Scenario: Future (2017) with Project Conditions
Count Date: **Analyst:** **Date:**

		AM PEAK HOUR			PM PEAK HOUR		
		Volume	No. of Lanes	Lane Volume	Volume	No. of Lanes	Lane Volume
No. of Phases Opposed Ø'ing: N/S-1, E/W-2 or Both-3? Right Turns: FREE-1, NRTOR-2 or OLA-3? ATSAC-1 or ATSAC+ATCS-2? Override Capacity				0			0
				0			0
		<i>NB --</i>		0	<i>NB --</i>		0
		<i>EB --</i>		0	<i>EB --</i>		0
				0			0
				1375			1375
MOVEMENT		Volume	No. of Lanes	Lane Volume	Volume	No. of Lanes	Lane Volume
NORTHBOUND	Left	0	0	0	0	0	0
	Left-Through		0			0	
	Through	0	0	0	0	0	0
	Through-Right		0			0	
	Right	0	0	0	0	0	0
	Left-Through-Right		0			0	
	Left-Right		0			0	
SOUTHBOUND	Left	626	2	344	384	2	211
	Left-Through		0			0	
	Through	0	0	0	0	0	0
	Through-Right		0			0	
	Right	0	0	0	0	0	0
	Left-Through-Right		0			0	
	Left-Right		0			0	
EASTBOUND	Left	0	0	0	0	0	0
	Left-Through		0			0	
	Through	1226	3	409	858	3	286
	Through-Right		0			0	
	Right	0	0	0	0	0	0
	Left-Through-Right		0			0	
	Left-Right		0			0	
WESTBOUND	Left	0	0	0	0	0	0
	Left-Through		0			0	
	Through	0	0	0	0	0	0
	Through-Right		0			0	
	Right	0	0	0	0	0	0
	Left-Through-Right		0			0	
	Left-Right		0			0	
CRITICAL VOLUMES				<i>North-South:</i>	<i>North-South:</i>		211
				<i>East-West:</i>	<i>East-West:</i>		286
				<i>SUM:</i>	<i>SUM:</i>		497
VOLUME/CAPACITY (V/C) RATIO:				0.548			0.361
V/C LESS ATSAC/ATCS ADJUSTMENT:				0.548			0.361
LEVEL OF SERVICE (LOS):				A			A

Level of Service Worksheet (Circular 212 Method)



I/S #:
3

PROJECT TITLE: LAX Terminal 1 Improvement Project
North-South Street: East Way **East-West Street:** World Way South (Upper Level)
Scenario: Future (2017) with Project Conditions
Count Date: **Analyst:** **Date:**

		AM PEAK HOUR			PM PEAK HOUR		
		Volume	No. of Lanes	Lane Volume	Volume	No. of Lanes	Lane Volume
No. of Phases Opposed Ø'ing: N/S-1, E/W-2 or Both-3? Right Turns: FREE-1, NRTOR-2 or OLA-3? ATSAC-1 or ATSAC+ATCS-2? Override Capacity				0			0
				0			0
		<i>NB --</i>	<i>SB --</i>	0	<i>NB --</i>	<i>SB --</i>	0
		<i>EB --</i>	<i>WB --</i>	0	<i>EB --</i>	<i>WB --</i>	0
				1375			1375
MOVEMENT		Volume	No. of Lanes	Lane Volume	Volume	No. of Lanes	Lane Volume
NORTHBOUND	↵ Left	0	0	0	0	0	0
	↵↔ Left-Through		0			0	
	→ Through	0	0	0	0	0	0
	→↔ Through-Right		0			0	
	↘ Right	0	0	0	0	0	0
	↵↔↘ Left-Through-Right		0			0	
	↘↔ Left-Right		0			0	
SOUTHBOUND	↵ Left	520	2	286	361	2	199
	↵↔ Left-Through		0			0	
	→ Through	0	0	0	0	0	0
	→↔ Through-Right		0			0	
	↘ Right	0	0	0	0	0	0
	↵↔↘ Left-Through-Right		0			0	
	↘↔ Left-Right		0			0	
EASTBOUND	↵ Left	0	0	0	0	0	0
	↵↔ Left-Through		0			0	
	→ Through	1964	3	655	1199	3	400
	→↔ Through-Right		0			0	
	↘ Right	0	0	0	0	0	0
	↵↔↘ Left-Through-Right		0			0	
	↘↔ Left-Right		0			0	
WESTBOUND	↵ Left	0	0	0	0	0	0
	↵↔ Left-Through		0			0	
	→ Through	0	0	0	0	0	0
	→↔ Through-Right		0			0	
	↘ Right	0	0	0	0	0	0
	↵↔↘ Left-Through-Right		0			0	
	↘↔ Left-Right		0			0	
CRITICAL VOLUMES				<i>North-South:</i> 286 <i>East-West:</i> 655 <i>SUM:</i> 941			<i>North-South:</i> 199 <i>East-West:</i> 400 <i>SUM:</i> 599
VOLUME/CAPACITY (V/C) RATIO:				0.684			0.436
V/C LESS ATSAC/ATCS ADJUSTMENT:				0.684			0.436
LEVEL OF SERVICE (LOS):				B			A

Level of Service Worksheet (Circular 212 Method)



I/S #:
4

PROJECT TITLE: LAX Terminal 1 Improvement Project
North-South Street: Sky Way **East-West Street:** World Way North (Lower Level)
Scenario: Future (2017) with Project Conditions
Count Date: **Analyst:** **Date:**

		AM PEAK HOUR			PM PEAK HOUR		
		Volume	No. of Lanes	Lane Volume	Volume	No. of Lanes	Lane Volume
No. of Phases Opposed Ø'ing: N/S-1, E/W-2 or Both-3? Right Turns: FREE-1, NRTOR-2 or OLA-3? ATSAC-1 or ATSAC+ATCS-2? Override Capacity				0 1 0 0 0 1375			0 1 0 0 0 1375
		<i>NB --</i>	<i>SB --</i>		<i>NB --</i>	<i>SB --</i>	
		<i>EB --</i>	<i>WB --</i>		<i>EB --</i>	<i>WB --</i>	
MOVEMENT		Volume	No. of Lanes	Lane Volume	Volume	No. of Lanes	Lane Volume
NORTHBOUND	Left	331	2	182	338	2	186
	Left-Through		0			0	
	Through	185	1	185	159	1	159
	Through-Right		0			0	
	Right	0	0	0	0	0	0
	Left-Through-Right		0			0	
	Left-Right		0			0	
SOUTHBOUND	Left	0	0	0	0	0	0
	Left-Through		0			0	
	Through	0	0	0	0	0	0
	Through-Right		0			0	
	Right	288	3	101	845	3	296
	Left-Through-Right		0			0	
	Left-Right		0			0	
EASTBOUND	Left	0	0	0	0	0	0
	Left-Through		0			0	
	Through	0	0	0	0	0	0
	Through-Right		0			0	
	Right	0	0	0	0	0	0
	Left-Through-Right		0			0	
	Left-Right		0			0	
WESTBOUND	Left	0	0	0	0	0	0
	Left-Through		0			0	
	Through	728	6	121	1359	6	227
	Through-Right		0			0	
	Right	0	0	0	0	0	0
	Left-Through-Right		0			0	
	Left-Right		0			0	
CRITICAL VOLUMES				<i>North-South:</i> 286 <i>East-West:</i> 121 <i>SUM:</i> 407			<i>North-South:</i> 482 <i>East-West:</i> 227 <i>SUM:</i> 709
VOLUME/CAPACITY (V/C) RATIO:				0.296			0.516
V/C LESS ATSAC/ATCS ADJUSTMENT:				0.296			0.516
LEVEL OF SERVICE (LOS):				A			A

Level of Service Worksheet (Circular 212 Method)



I/S #:
5

PROJECT TITLE: LAX Terminal 1 Improvement Project
North-South Street: West Way **East-West Street:** Center Way
Scenario: Future (2017) with Project Conditions
Count Date: **Analyst:** **Date:**

		AM PEAK HOUR			PM PEAK HOUR		
		Volume	No. of Lanes	Lane Volume	Volume	No. of Lanes	Lane Volume
No. of Phases Opposed Ø'ing: N/S-1, E/W-2 or Both-3? Right Turns: FREE-1, NRTOR-2 or OLA-3? ATSAC-1 or ATSAC+ATCS-2? Override Capacity				0			0
				0			0
		NB --	SB --	0	NB --	SB --	0
		EB --	WB --	0	EB --	WB --	0
				0			0
				1375			1375
MOVEMENT		Volume	No. of Lanes	Lane Volume	Volume	No. of Lanes	Lane Volume
NORTHBOUND	↶ Left	0	0	0	0	0	0
	↶↷ Left-Through		0			0	
	→ Through	2	1	2	41	1	41
	↷ Through-Right		0			0	
	↷ Right	0	0	0	0	0	0
	↶↷↷ Left-Through-Right		0			0	
	↷↷ Left-Right		0			0	
SOUTHBOUND	↷ Left	1	0	1	89	0	89
	↷↷ Left-Through		1			1	
	→ Through	118	1	60	278	1	184
	↷ Through-Right		0			0	
	↷ Right	0	0	0	0	0	0
	↷↷ Left-Through-Right		0			0	
	↷↷ Left-Right		0			0	
EASTBOUND [1]	↶ Left	80	0	80	56	0	56
	↶↷ Left-Through		1			1	
	→ Through	24	1	24	305	1	181
	↷ Through-Right		0			0	
	↷ Right	0	0	0	0	0	0
	↶↷↷ Left-Through-Right		0			0	
	↷↷ Left-Right		0			0	
WESTBOUND	↶ Left	0	0	0	0	0	0
	↶↷ Left-Through		0			0	
	→ Through	0	0	0	0	0	0
	↷ Through-Right		0			0	
	↷ Right	0	0	0	0	0	0
	↶↷↷ Left-Through-Right		0			0	
	↷↷ Left-Right		0			0	
CRITICAL VOLUMES				<i>North-South:</i> 60			<i>North-South:</i> 184
				<i>East-West:</i> 80			<i>East-West:</i> 181
				SUM: 140			SUM: 365
VOLUME/CAPACITY (V/C) RATIO:				0.102			0.265
V/C LESS ATSAC/ATCS ADJUSTMENT:				0.102			0.265
LEVEL OF SERVICE (LOS):				A			A

[1] Worst case approach.

Level of Service Worksheet (Circular 212 Method)



I/S #:
6

PROJECT TITLE: LAX Terminal 1 Improvement Project
North-South Street: East Way **East-West Street:** Center Way
Scenario: Future (2017) with Project Conditions
Count Date: **Analyst:** **Date:**

		AM PEAK HOUR			PM PEAK HOUR		
		Volume	No. of Lanes	Lane Volume	Volume	No. of Lanes	Lane Volume
No. of Phases Opposed Ø'ing: N/S-1, E/W-2 or Both-3? Right Turns: FREE-1, NRTOR-2 or OLA-3? ATSAC-1 or ATSAC+ATCS-2? Override Capacity				0			0
				0			0
		NB --		0	NB --		0
		EB --		0	EB --		0
				0			0
				1375			1375
MOVEMENT		Volume	No. of Lanes	Lane Volume	Volume	No. of Lanes	Lane Volume
NORTHBOUND	↵ Left	0	0	0	0	0	0
	↵↔ Left-Through		0			0	
	→ Through	45	2	23	208	2	104
	→↔ Through-Right		0			0	
	↘ Right	0	0	0	0	0	0
	↵↔↔ Left-Through-Right		0			0	
	↵↔↔ Left-Right		0			0	
SOUTHBOUND	↵ Left	43	0	43	27	0	27
	↵↔ Left-Through		1			1	
	→ Through	113	1	78	332	1	180
	→↔ Through-Right		0			0	
	↘ Right	0	0	0	0	0	0
	↵↔↔ Left-Through-Right		0			0	
	↵↔↔ Left-Right		0			0	
EASTBOUND [1]	↵ Left	0	0	0	19	0	19
	↵↔ Left-Through		0			1	
	→ Through	124	1	124	845	2	288
	→↔ Through-Right		0			0	
	↘ Right	0	0	0	0	0	0
	↵↔↔ Left-Through-Right		0			0	
	↵↔↔ Left-Right		0			0	
WESTBOUND	↵ Left	0	0	0	0	0	0
	↵↔ Left-Through		0			0	
	→ Through	0	0	0	0	0	0
	→↔ Through-Right		0			0	
	↘ Right	0	0	0	0	0	0
	↵↔↔ Left-Through-Right		0			0	
	↵↔↔ Left-Right		0			0	
CRITICAL VOLUMES				<i>North-South:</i> 78			<i>North-South:</i> 180
				<i>East-West:</i> 124			<i>East-West:</i> 288
				SUM: 202			SUM: 468
VOLUME/CAPACITY (V/C) RATIO:				0.147			0.340
V/C LESS ATSAC/ATCS ADJUSTMENT:				0.147			0.340
LEVEL OF SERVICE (LOS):				A			A

[1] Worst case approach.

Level of Service Worksheet (Circular 212 Method)



I/S #:
7

PROJECT TITLE: LAX Terminal 1 Improvement Project
North-South Street: World Way South **East-West Street:** Center Way
Scenario: Future (2017) with Project Conditions
Count Date: **Analyst:** **Date:**

		AM PEAK HOUR			PM PEAK HOUR		
		Volume	No. of Lanes	Lane Volume	Volume	No. of Lanes	Lane Volume
No. of Phases Opposed Ø'ing: N/S-1, E/W-2 or Both-3? Right Turns: FREE-1, NRTOR-2 or OLA-3? ATSAC-1 or ATSAC+ATCS-2? Override Capacity				0			0
				0			0
		<i>NB</i> -- 0	<i>SB</i> -- 0	0	<i>NB</i> -- 0	<i>SB</i> -- 0	0
		<i>EB</i> -- 2	<i>WB</i> -- 0	0	<i>EB</i> -- 2	<i>WB</i> -- 0	0
				0			0
				1375			1375
MOVEMENT		Volume	No. of Lanes	Lane Volume	Volume	No. of Lanes	Lane Volume
NORTHBOUND	↵ Left	200	1	169	448	1	363
	↵↵ Left-Through		1			1	
	→ Through	474	2	169	1002	2	363
	→↵ Through-Right		0			0	
	↵ Right	203	2	112	550	2	303
	↵↵ Left-Through-Right		0			0	
	↵↵ Left-Right		0			0	
SOUTHBOUND	↵ Left	0	0	0	0	0	0
	↵↵ Left-Through		0			0	
	→ Through	0	0	0	0	0	0
	→↵ Through-Right		0			0	
	↵ Right	0	0	0	0	0	0
	↵↵ Left-Through-Right		0			0	
	↵↵ Left-Right		0			0	
EASTBOUND	↵ Left	18	0	18	22	0	22
	↵↵ Left-Through		1			1	
	→ Through	672	1	230	1052	1	429
	→↵ Through-Right		1			1	
	↵ Right	197	1	197	642	1	429
	↵↵ Left-Through-Right		0			0	
	↵↵ Left-Right		0			0	
WESTBOUND	↵ Left	0	0	0	0	0	0
	↵↵ Left-Through		0			0	
	→ Through	0	0	0	0	0	0
	→↵ Through-Right		0			0	
	↵ Right	0	0	0	0	0	0
	↵↵ Left-Through-Right		0			0	
	↵↵ Left-Right		0			0	
CRITICAL VOLUMES				<i>North-South:</i> 169 <i>East-West:</i> 230 <i>SUM:</i> 399			<i>North-South:</i> 363 <i>East-West:</i> 429 <i>SUM:</i> 792
VOLUME/CAPACITY (V/C) RATIO:				0.290			0.576
V/C LESS ATSAC/ATCS ADJUSTMENT:				0.290			0.576
LEVEL OF SERVICE (LOS):				A			A

Level of Service Worksheet (Circular 212 Method)



I/S #:
1

PROJECT TITLE: LAX Terminal 1 Improvement Project
North-South Street: Sky Way **East-West Street:** World Way North (Upper Level)
Scenario: Future (2017) with Project Conditions
Count Date: Year 2013 **Analyst:** **Date:**

		MD PEAK HOUR					
				0			0
No. of Phases				0			0
Opposed Ø'ing: N/S-1, E/W-2 or Both-3?				0			0
Right Turns: FREE-1, NRTOR-2 or OLA-3?		NB -- 0	SB -- 0	0	NB -- 0	SB -- 0	0
ATSAC-1 or ATSAC+ATCS-2?		EB -- 0	WB -- 0	0	EB -- 0	WB -- 0	0
Override Capacity				1375			0
MOVEMENT		Volume	No. of Lanes	Lane Volume	Volume	No. of Lanes	Lane Volume
NORTHBOUND	↵ Left	0	0	0		0	0
	↵↔ Left-Through		0			0	
	→ Through	0	0	0		0	
	→↔ Through-Right		0			0	
	↘ Right	0	0	0		0	
	↵↔↔ Left-Through-Right		0			0	
	↵↔ Left-Right		0			0	
SOUTHBOUND	↵ Left	0	0	0		0	0
	↵↔ Left-Through		0			0	
	→ Through	0	0	0		0	0
	→↔ Through-Right		0			0	
	↘ Right	778	3	272		0	0
	↵↔↔ Left-Through-Right		0			0	
	↵↔ Left-Right		0			0	
EASTBOUND	↵ Left	0	0	0		0	0
	↵↔ Left-Through		0			0	
	→ Through	0	0	0		0	0
	→↔ Through-Right		0			0	
	↘ Right	0	0	0		0	0
	↵↔↔ Left-Through-Right		0			0	
	↵↔ Left-Right		0			0	
WESTBOUND	↵ Left	0	0	0		0	0
	↵↔ Left-Through		0			0	
	→ Through	1683	4	421		0	0
	→↔ Through-Right		0			0	
	↘ Right	0	0	0		0	0
	↵↔↔ Left-Through-Right		0			0	
	↵↔ Left-Right		0			0	
CRITICAL VOLUMES				North-South: 272			North-South: 0
				East-West: 421			East-West: 0
				SUM: 693			SUM: 0
VOLUME/CAPACITY (V/C) RATIO:				0.504			0.000
V/C LESS ATSAC/ATCS ADJUSTMENT:				0.504			0.000
LEVEL OF SERVICE (LOS):				A			A

Level of Service Worksheet (Circular 212 Method)



I/S #:
2

PROJECT TITLE: LAX Terminal 1 Improvement Project
North-South Street: West Way **East-West Street:** World Way South (Upper Level)
Scenario: Future (2017) with Project Conditions
Count Date: Year 2013 **Analyst:** **Date:**

		MD PEAK HOUR					
				0			0
No. of Phases				0			0
Opposed Ø'ing: N/S-1, E/W-2 or Both-3?				0			0
Right Turns: FREE-1, NRTOR-2 or OLA-3?		NB -- 0	SB -- 0	0	NB -- 0	SB -- 0	0
ATSAC-1 or ATSAC+ATCS-2?		EB -- 0	WB -- 0	0	EB -- 0	WB -- 0	0
Override Capacity				1375			0
MOVEMENT		Volume	No. of Lanes	Lane Volume	Volume	No. of Lanes	Lane Volume
NORTHBOUND	↵ Left	0	0	0		0	0
	↵↔ Left-Through		0			0	
	→ Through	0	0	0		0	
	→↔ Through-Right		0			0	
	↘ Right	0	0	0		0	
	↵↔↔ Left-Through-Right		0			0	
	↵↔ Left-Right		0			0	
SOUTHBOUND	↵ Left	585	2	322		0	0
	↵↔ Left-Through		0			0	
	→ Through	0	0	0		0	0
	→↔ Through-Right		0			0	
	↘ Right	0	0	0		0	0
	↵↔↔ Left-Through-Right		0			0	
	↵↔ Left-Right		0			0	
EASTBOUND	↵ Left	0	0	0		0	0
	↵↔ Left-Through		0			0	
	→ Through	1171	3	390		0	0
	→↔ Through-Right		0			0	
	↘ Right	0	0	0		0	0
	↵↔↔ Left-Through-Right		0			0	
	↵↔ Left-Right		0			0	
WESTBOUND	↵ Left	0	0	0		0	0
	↵↔ Left-Through		0			0	
	→ Through	0	0	0		0	0
	→↔ Through-Right		0			0	
	↘ Right	0	0	0		0	0
	↵↔↔ Left-Through-Right		0			0	
	↵↔ Left-Right		0			0	
CRITICAL VOLUMES				North-South: 322			North-South: 0
				East-West: 390			East-West: 0
				SUM: 712			SUM: 0
VOLUME/CAPACITY (V/C) RATIO:				0.518			0.000
V/C LESS ATSAC/ATCS ADJUSTMENT:				0.518			0.000
LEVEL OF SERVICE (LOS):				A			A

Level of Service Worksheet (Circular 212 Method)



I/S #:
3

PROJECT TITLE: LAX Terminal 1 Improvement Project
North-South Street: East Way **East-West Street:** World Way South (Upper Level)
Scenario: Future (2017) with Project Conditions
Count Date: Year 2013 **Analyst:** **Date:**

		MD PEAK HOUR					
				0			0
No. of Phases				0			0
Opposed Ø'ing: N/S-1, E/W-2 or Both-3?				0			0
Right Turns: FREE-1, NRTOR-2 or OLA-3?		NB -- 0	SB -- 0	0	NB -- 0	SB -- 0	0
ATSAC-1 or ATSAC+ATCS-2?		EB -- 0	WB -- 0	0	EB -- 0	WB -- 0	0
Override Capacity				1375			0
MOVEMENT		Volume	No. of Lanes	Lane Volume	Volume	No. of Lanes	Lane Volume
NORTHBOUND	↶ Left	0	0	0		0	0
	↶↷ Left-Through		0			0	
	→ Through	0	0	0		0	
	↷ Through-Right		0			0	
	↷ Right	0	0	0		0	
	↷↶ Left-Through-Right		0			0	
	↷↶ Left-Right		0			0	
SOUTHBOUND	↷ Left	498	2	274		0	0
	↷↶ Left-Through		0			0	
	→ Through	0	0	0		0	
	↶ Through-Right		0			0	
	↶ Right	0	0	0		0	
	↶↷ Left-Through-Right		0			0	
	↶↷ Left-Right		0			0	
EASTBOUND	↶ Left	0	0	0		0	0
	↶↷ Left-Through		0			0	
	→ Through	1609	3	536		0	0
	↷ Through-Right		0			0	
	↷ Right	0	0	0		0	
	↷↶ Left-Through-Right		0			0	
	↷↶ Left-Right		0			0	
WESTBOUND	↶ Left	0	0	0		0	0
	↶↷ Left-Through		0			0	
	→ Through	0	0	0		0	
	↷ Through-Right		0			0	
	↷ Right	0	0	0		0	
	↷↶ Left-Through-Right		0			0	
	↷↶ Left-Right		0			0	
CRITICAL VOLUMES				North-South: 274			North-South: 0
				East-West: 536			East-West: 0
				SUM: 810			SUM: 0
VOLUME/CAPACITY (V/C) RATIO:				0.589			0.000
V/C LESS ATSAC/ATCS ADJUSTMENT:				0.589			0.000
LEVEL OF SERVICE (LOS):				A			A

Level of Service Worksheet (Circular 212 Method)



I/S #:
4

PROJECT TITLE: LAX Terminal 1 Improvement Project
North-South Street: Sky Way **East-West Street:** World Way North (Lower Level)
Scenario: Future (2017) with Project Conditions
Count Date: Year 2013 **Analyst:** **Date:**

		MD PEAK HOUR					
				0			0
No. of Phases				1			0
Opposed Ø'ing: N/S-1, E/W-2 or Both-3?				0			0
Right Turns: FREE-1, NRTOR-2 or OLA-3?		NB -- 0	SB -- 0	0	NB -- 0	SB -- 0	0
ATSAC-1 or ATSAC+ATCS-2?		EB -- 0	WB -- 0	0	EB -- 0	WB -- 0	0
Override Capacity				1375			0
MOVEMENT		Volume	No. of Lanes	Lane Volume	Volume	No. of Lanes	Lane Volume
NORTHBOUND	↶ Left	380	2	209		0	0
	↶↷ Left-Through		0			0	
	→ Through	168	1	168		0	0
	↷ Through-Right		0			0	0
	↷ Right	0	0	0		0	0
	↷↶ Left-Through-Right		0			0	
	↷↶ Left-Right		0			0	
SOUTHBOUND	↷ Left	0	0	0		0	0
	↷↶ Left-Through		0			0	
	→ Through	0	0	0		0	0
	↶ Through-Right		0			0	0
	↶ Right	823	3	288		0	0
	↶↷ Left-Through-Right		0			0	
	↶↷ Left-Right		0			0	
EASTBOUND	↶ Left	0	0	0		0	0
	↶↷ Left-Through		0			0	
	→ Through	0	0	0		0	0
	↷ Through-Right		0			0	0
	↷ Right	0	0	0		0	0
	↷↶ Left-Through-Right		0			0	
	↷↶ Left-Right		0			0	
WESTBOUND	↶ Left	0	0	0		0	0
	↶↷ Left-Through		0			0	
	→ Through	1578	6	263		0	0
	↷ Through-Right		0			0	0
	↷ Right	0	0	0		0	0
	↷↶ Left-Through-Right		0			0	
	↷↶ Left-Right		0			0	
CRITICAL VOLUMES				North-South: 497			North-South: 0
				East-West: 263			East-West: 0
				SUM: 760			SUM: 0
VOLUME/CAPACITY (V/C) RATIO:				0.553			0.000
V/C LESS ATSAC/ATCS ADJUSTMENT:				0.553			0.000
LEVEL OF SERVICE (LOS):				A			A

Level of Service Worksheet (Circular 212 Method)



I/S #:
5

PROJECT TITLE: LAX Terminal 1 Improvement Project
North-South Street: West Way **East-West Street:** Center Way
Scenario: Future (2017) with Project Conditions
Count Date: Year 2013 **Analyst:** **Date:**

		MD PEAK HOUR					
				0			0
No. of Phases				0			0
Opposed Ø'ing: N/S-1, E/W-2 or Both-3?				0			0
Right Turns: FREE-1, NRTOR-2 or OLA-3?		NB -- 0	SB -- 0	0	NB -- 0	SB -- 0	0
ATSAC-1 or ATSAC+ATCS-2?		EB -- 0	WB -- 0	0	EB -- 0	WB -- 0	0
Override Capacity				1375			0
MOVEMENT		Volume	No. of Lanes	Lane Volume	Volume	No. of Lanes	Lane Volume
NORTHBOUND	↵ Left	0	0	0		0	0
	↵↔ Left-Through		0			0	
	→ Through	19	1	19		0	0
	→↔ Through-Right		0			0	
	↘ Right	0	0	0		0	0
	↵↔↔ Left-Through-Right		0			0	
	↵↔ Left-Right		0			0	
SOUTHBOUND	↵ Left	82	0	82		0	0
	↵↔ Left-Through		1			0	
	→ Through	349	1	216		0	0
	→↔ Through-Right		0			0	
	↘ Right	0	0	0		0	0
	↵↔↔ Left-Through-Right		0			0	
	↵↔ Left-Right		0			0	
EASTBOUND [1]	↵ Left	22	0	22		0	0
	↵↔ Left-Through		1			0	
	→ Through	257	1	140		0	0
	→↔ Through-Right		0			0	
	↘ Right	0	0	0		0	0
	↵↔↔ Left-Through-Right		0			0	
	↵↔ Left-Right		0			0	
WESTBOUND	↵ Left	0	0	0		0	0
	↵↔ Left-Through		0			0	
	→ Through	0	0	0		0	0
	→↔ Through-Right		0			0	
	↘ Right	0	0	0		0	0
	↵↔↔ Left-Through-Right		0			0	
	↵↔ Left-Right		0			0	
CRITICAL VOLUMES				North-South: 216			North-South: 0
				East-West: 140			East-West: 0
				SUM: 356			SUM: 0
VOLUME/CAPACITY (V/C) RATIO:				0.259			0.000
V/C LESS ATSAC/ATCS ADJUSTMENT:				0.259			0.000
LEVEL OF SERVICE (LOS):				A			A

[1] Worst case approach.

Level of Service Worksheet (Circular 212 Method)



I/S #:
6

PROJECT TITLE: LAX Terminal 1 Improvement Project
North-South Street: East Way **East-West Street:** Center Way
Scenario: Future (2017) with Project Conditions
Count Date: Year 2013 **Analyst:** **Date:**

		MD PEAK HOUR					
				0			0
No. of Phases				0			0
Opposed Ø'ing: N/S-1, E/W-2 or Both-3?				0			0
Right Turns: FREE-1, NRTOR-2 or OLA-3?		NB -- 0	SB -- 0	0	NB -- 0	SB -- 0	0
ATSAC-1 or ATSAC+ATCS-2?		EB -- 0	WB -- 0	0	EB -- 0	WB -- 0	0
Override Capacity				1375			0
MOVEMENT		Volume	No. of Lanes	Lane Volume	Volume	No. of Lanes	Lane Volume
NORTHBOUND	↶ Left	0	0	0		0	0
	↶↷ Left-Through		0			0	
	→ Through	178	2	89		0	0
	↷ Through-Right		0			0	
	→ Right	0	0	0		0	0
	↷↶ Left-Through-Right		0			0	
	↷ Left-Right		0			0	
SOUTHBOUND	↷ Left	38	0	38		0	0
	↷↶ Left-Through		1			0	
	→ Through	236	1	137		0	0
	↶ Through-Right		0			0	
	→ Right	0	0	0		0	0
	↶↷ Left-Through-Right		0			0	
	↶ Left-Right		0			0	
EASTBOUND	↶ Left	22	0	0		0	0
	↶↷ Left-Through		0			0	
	→ Through	787	1	394		0	0
	↷ Through-Right		1			0	
	→ Right	0	0	0		0	0
	↷↶ Left-Through-Right		0			0	
	↷ Left-Right		0			0	
WESTBOUND	↷ Left	0	0	0		0	0
	↷↶ Left-Through		0			0	
	→ Through	0	0	0		0	0
	↶ Through-Right		0			0	
	→ Right	0	0	0		0	0
	↶↷ Left-Through-Right		0			0	
	↶ Left-Right		0			0	
CRITICAL VOLUMES				North-South: 137			North-South: 0
				East-West: 394			East-West: 0
				SUM: 531			SUM: 0
VOLUME/CAPACITY (V/C) RATIO:				0.386			0.000
V/C LESS ATSAC/ATCS ADJUSTMENT:				0.386			0.000
LEVEL OF SERVICE (LOS):				A			A

Level of Service Worksheet (Circular 212 Method)



I/S #:
7

PROJECT TITLE: LAX Terminal 1 Improvement Project
North-South Street: World Way South **East-West Street:** Center Way
Scenario: Future (2017) with Project Conditions
Count Date: Year 2013 **Analyst:** **Date:**

		MD PEAK HOUR					
				0			0
No. of Phases				0			0
Opposed Ø'ing: N/S-1, E/W-2 or Both-3?				0			0
Right Turns: FREE-1, NRTOR-2 or OLA-3?		NB -- 0	SB -- 0	0	NB -- 0	SB -- 0	0
ATSAC-1 or ATSAC+ATCS-2?		EB -- 2	WB -- 0	0	EB -- 0	WB -- 0	0
Override Capacity				1375			0
MOVEMENT		Volume	No. of Lanes	Lane Volume	Volume	No. of Lanes	Lane Volume
NORTHBOUND	↵ Left	458	1	409		0	0
	↵↔ Left-Through		1			0	
	→ Through	1178	2	409		0	0
	↘ Through-Right		0			0	
	↘ Right	707	2	389		0	0
	↵↔ Left-Through-Right		0			0	
	↵↔ Left-Right		0			0	
SOUTHBOUND	↵ Left	0	0	0		0	0
	↵↔ Left-Through		0			0	
	→ Through	0	0	0		0	0
	↘ Through-Right		0			0	
	↘ Right	0	0	0		0	0
	↵↔ Left-Through-Right		0			0	
	↵↔ Left-Right		0			0	
EASTBOUND	↵ Left	28	0	28		0	0
	↵↔ Left-Through		1			0	
	→ Through	1013	1	403		0	0
	↘ Through-Right		1			0	
	↘ Right	572	1	403		0	0
	↵↔ Left-Through-Right		0			0	
	↵↔ Left-Right		0			0	
WESTBOUND	↵ Left	0	0	0		0	0
	↵↔ Left-Through		0			0	
	→ Through	0	0	0		0	0
	↘ Through-Right		0			0	
	↘ Right	0	0	0		0	0
	↵↔ Left-Through-Right		0			0	
	↵↔ Left-Right		0			0	
CRITICAL VOLUMES				<i>North-South:</i> 409			<i>North-South:</i> 0
				<i>East-West:</i> 403			<i>East-West:</i> 0
				<i>SUM:</i> 812			<i>SUM:</i> 0
VOLUME/CAPACITY (V/C) RATIO:				0.591			0.000
V/C LESS ATSAC/ATCS ADJUSTMENT:				0.591			0.000
LEVEL OF SERVICE (LOS):				A			A